



1043 N. 47th Ave., Phoenix, AZ 85043 USA | www.amsafe.com
602-850-2850

SOARS Customer Service: SOARS@amsafe.com
SOARS Technical Support: SOARS_Support@amsafe.com

Installation Manual

AmSafe State of the Art Restraint System (SOARS)

Inflatable Kit Assembly Part Number: K7336

for Part 23 Aircraft

AmSafe Document Number: IM7336

The information contained herein is confidential and proprietary to AmSafe. The information in this document shall not be reproduced or disclosed, in whole or in part, to persons other than those necessary for the user to utilize such information or used in any manner detrimental to AmSafe's interests or for the purpose for which such information was provided without the express, written consent of AmSafe, except to the extent required for installation or maintenance of recipient's equipment.

The technical data in this document is controlled for export under the Export Administration Regulations (EAR), 15 CFR Parts 730-774 and ECCN 9A991. Violations of these laws may be subject to fines and penalties under the Export Administration Act.

Freedom of Information Act (5 USC §552) and Disclosure of Confidential Information (generally 18 USC §1905). AmSafe is furnishing this document in confidence. The information disclosed herein falls within exemption (b) (4) of 5 USC §552 and the prohibitions of 18 USC §1905.

The AmSafe Commercial and Government Entity (CAGE) code: 35FB9

25-10-01

Initial Issue: 05-Jun-2018
24-Sep-2018



LETTER OF TRANSMITTAL

To: Holders of IM7336, revision C, dated 24-Sep-2018. IM7336 addresses inflatable kit assembly part number K7336.

REVISION HIGHLIGHTS

A complete reissue accomplishes the changes (summarized below). Remove and replace all pages.

Page(s)	Correction/Update
All	Changed the email address for SOARS Technical Support.
ii	Is "13-Jul-2018" was "03-Jul-2018" for issue A.
1	Deleted "C" from Table 1. Is "AmSafe" was "References - AmSafe" in paragraph B.(2) and is "Regulatory" was "References - Regulatory" in paragraph B.(3).
2	Deleted "LH," "P/N" and "RH" from Table 1.
3	Is "two-point restraint" was "2-point restraint" in the first note in paragraph (1). Added an inertia reel cover, caution tag and cable tie to Figure 1. Is "mounting points" was "attachment points" in paragraph (2)(a)2.
4	Added an inertia reel cover, caution tag and cable tie to Figures 2 and 3.
5	Is "people" was "persons" in the warning in paragraphs B and B.(2) and the second warning in paragraph (4). Delete paragraph (3)(a) that referenced the EMA system safety compliance in Appendix A. Added the third warning and step (b) in paragraph (4).
6	Added Figure 4.
7	Is "Figure 5" was "Figure 4" in step 3.A.(1) and Figure 5. Added an inertia reel cover, caution tag and cable tie to Figure 4 and deleted their individual graphics in Figure 4.
8	Is "-65" was "65." Added "not illustrated" and revised the information on the dust cap, retaining washer and beaded nylon cable tie in the last row of Table 2.
10	Is "mounting point" was "attachment point" in paragraph (3)(c)1 and (3)(c)2. Is "Figure 7" was "Figure 6" in paragraph (4)(a).
11	Is "Figure 8" was "Figure 7" in paragraph (c) at the top of the page. Is "Figure 9" was "Figure 8" in the fourth bullet in step (h).
12	Is "Figure 7" was "Figure 6." Is "Figure 8" was "Figure 7." Is "Figure 9" was "Figure 8."
13	Added the first and second notes in paragraph D. Moved information in step (5)(a) to the third and fourth notes in paragraph D. Moved information in step (5)(b) and (5)(c) to pages 14 and 15, step (d)2b. Is "Figure 10" was "Figure 9" in step (1)(c). Is "Figure 10, Figure 22 and Figure 23" was "Figure 9 and Figure 21" in step (1)(d). Added step (1)(g). Is "Figure 10" was "Figure 9" in step (4).



Page(s)	Correction/Update
14	Is "mounting point" was "attachment point on the inboard side of the seat" in step (4)(b).
	Added the second note in step (b).
	Is "mounting point" was "existing attachment point on the outboard side of the seat" in step (c).
	Added the second note in step (c).
	Is "mounting point" was "attachment point" in the third note in step (c) and step (d).
	Is "two-point restraint" was "2-point restraint (5 - 10)" in the second note in step (d).
	Added steps 1 and 2 to step (d).
15	Added the first two notes in step (f).
	Is "Figure 12" was "Figure 11" in step (f)2.
	Is "Figure 13" was "Figure 12" in step (f)3.
	Is "Figure 14" was "Figure 13" in step 4a.
	Is "Figure 15" was "Figure 14" in step 4b.
16	Is "Figure 16" was "Figure 15" in step e at the top of the page.
	Is "Figure 17" was "Figure 16" in step 5b.
	Is "Figure 18" was "Figure 17" in step 5c.
	Is "Figure 19" was "Figure 18" in step 5f.
	Is "Figure 20" was "Figure 19" in step 5g.
	Is "Figure 11" was "Figure 20" in step h.
	Is "restraint" was "restraint (5 - 10)" in the note at the end of the page.
17	Added an inertia reel cover, caution tag and cable tie to Figure 9 and deleted the individual graphics in Figure 9.
	Is "Figure 10" was "Figure 9."
	Is "Figure 11" was "Figure 10."
18	Is "Figure 12" was "Figure 11."
	Is "Figure 13" was "Figure 12."
19	Is "Figure 14" was "Figure 13."
	Is "Figure 15" was "Figure 14."
20	Is "Figure 16" was "Figure 15."
21	Is "Figure 17" was "Figure 16."
22	Is "Figure 18" was "Figure 17."
	Is "Figure 19" was "Figure 18."
23	Is "Figure 20" was "Figure 19."
24	Is "Figure 21" was "Figure 20."
	Is "death or injury to people or damage to equipment" was "death or injury may result" in the first warning in step (5).
	Added the third warning in step (5).
	Is "people" was "persons" in the fourth warning in step (5).
	Added information on handling the inflator assembly to step (a).
25	Added Figure 23.
	Is "Figure 23" was "Figure 22."
	Is "Figure 24" was "Figure 22" in step (d).
26	Is "Figure 24" was "Figure 22."
	Is "Figure 25" was "Figure 23."



Page(s)	Correction/Update
27	Is "Figure 26" was "Figure 24" in step (b).
	Is "Figure 27" was "Figure 25" in step 2a.
28	Is "gas that may" was "gas and may" in the warning preceding step (d).
	Is "Figure 28" was "Figure 26" in step (d).
	Is "Figure 29" was "Figure 27" in step (g)1.
	Is "Figure 30" was "Figure 28" in step (g)2.
	Is "Figure 31" was "Figure 29" in step (g)3.
	Is "Figure 32" was "Figure 30" in step (h).
	Is "Figure 33" was "Figure 31" in step (h).
29	Is "Figure 26" was "Figure 24."
	Is "Figure 27" was "Figure 25."
	Is "Figure 28" was "Figure 26."
30	Is "Figure 29" was "Figure 27."
	Is "Figure 30" was "Figure 28."
31	Is "Figure 31" was "Figure 29."
	Added an inertia reel cover, caution tag and cable tie to Figure 32.
	Is "Figure 32" was "Figure 30."
	Is "Figure 33" was "Figure 31."
34	Is "injure people or damage" was "cause injury to people or damage to" in the warning in step (b).
	Is "people" was "persons" in the warning in step (c).
	Is "Figure 34" was "Figure 32" in step (e).
	Is "Figure 35" was "Figure 33" in step (f).
	Is "Figure 36" was "Figure 34" in step (g).
35	Is "Figure 37" was "Figure 35" in step 3 at the top of the page.
	Is "Figure 38" was "Figure 36" in the third note in step (h).
37	Is "Figure 34" was "Figure 32."
	Is "Figure 35" was "Figure 33."
38	Is "Figure 36" was "Figure 34."
	Is "Figure 37" was "Figure 35."
	Is "Figure 38" was "Figure 36."
39	Is "Figure 39" was "Figure 37" in step (1)(b) and (3).
40	Added an inertia reel cover, caution tag and cable tie and deleted the individual graphics in Figure 39.
	Is "Figure 39" was "Figure 37."
41	Is "Figure 40" was "Figure 38" and is "Figure 41" was "Figure 40" in step (6)(a).
	Is "Figure 42" was "Figure 40" in step (6)(b).
	Is "Figure 43 and Figure 44" was "Figure 41 and Figure 42" in step (6)(c).

Page(s)	Correction/Update
42	Is "death or injury to people or damage to equipment" was "death or injury may result" in the first warning at the top of the page.
	Is "people" was "persons" in the second warning at the top of the page.
	Added information on handling the inflator assembly to step (e).
	Added an inertia reel cover, caution tag and cable tie to Figure 40.
	Is "Figure 40" was "Figure 38."
	Is "Figure 41" was "Figure 39."
43	Is "Figure 42" was "Figure 40."
	Is "Figure 43" was "Figure 41."
	Is "Figure 44" was "Figure 42."
	Added an inertia reel cover, caution tag and cable tie to Figure 44.
	Added Figure 45.
44	Is "two-point restraint" was "2-point restraint (5 - 10)" in the note in step (7)(a).
	Is "mounting point" was "attachment point" in step (7)(b).
	Added steps 1 and 2 to step (7)(b).
	Is "mounting points" was "attachment points" and is "Figure 46" was "Figure 43" in step (7)(c).
	Added the inertia reel cover to step (7)(d).
	Is "Figure 46" was "Figure 43."
45	Is "Figure 47" was "Figure 44."
	Is "Figure 48" was "Figure 45" in step (9)(b)1.
44	Is "Figure 48" was "Figure 45."
	Is "Figure 48" was "Figure 45."
46	Is "people" was "persons" in the first warning in step D.(1).
47	Added an inertia reel cover, caution tag and cable tie to Figure 49.
	Is "Figure 49" was "Figure 46."
	Is "people" was "persons" in the first warning in step (2).
48	Is "people" was "persons" in the second warning in paragraph (4).
49	Is "people" was "persons" in the first warning in paragraph (2).
51	Added the second warning in paragraph (b)
	Added information on handling the inflator assembly to step (b)1.
	Added Figure 50.



RECORD OF REVISION

On receipt of a revision insert IM7336 in the applicable manual and complete the date inserted and the initials of the person who inserted IM7336.

Rev. Letter	Issue Date	Date Inserted	Inserted By
-	05-Jun-2018		
A	13-Jul-2018		
B	03-Jul-2018		
C	24-Sep-2018		



1043 N. 47th Ave., Phoenix, AZ 85043 USA | www.amsafe.com
602-850-2850

SERVICE BULLETINS/LETTERS

Below is a list of applicable service documents. Access service bulletins/letters at AmSafe Aviation Secure Customer Site.

Doc. No.	Title	Date Original Issue	Revision and Date	Date Incorporated
N/A	N/A	N/A	N/A	N/A



TABLE OF CONTENTS

1. Introduction 1

2. Description and Operation 3

3. Illustrated Parts List 6

4. Installation 9

5. Testing and Fault Isolation 33

6. Removal 39

7. Storage 46

ATTACHMENT A - ARC AUTOMOTIVE SDS Attachment A-i

LIST OF FIGURES

Figure 1. System.....	3
Figure 2. Connector Half, Buckle Half and Shoulder Harness	4
Figure 3. Connector Half, Buckle Half and Shoulder Harness	4
Figure 4. Inflator Assembly Handling	6
Figure 5. Components.....	7
Figure 6. SOARS LOPA	8
Figure 7. EMA (100) Dimensions.....	12
Figure 8. EMA (100) Aircraft Forward Label	12
Figure 9. EMA (100) Bolt Holes	12
Figure 10. Components.....	17
Figure 11. End Fitting on the Connector Half (15 - 20)	17
Figure 12. Body Block (90) Placement	18
Figure 13. Connector Half (15 - 20) On Body Block (90)	18
Figure 14. Removing the Webbing From the 3-Bar Slide.....	19
Figure 15. Airbag Cover Alignment on Body Block (90)	19
Figure 16. Threading Webbing Through the 3-Bar Slide.....	20
Figure 17. Removing the Webbing on the 3-Bar Slide	21
Figure 18. Location of Buckle Assembly	22
Figure 19. Distance Between 3-Bar Slide and Buckle Assembly	22
Figure 20. Threading Webbing Through 3-Bar Slide	23
Figure 21. Connector Attached to Rivet	24
Figure 22. Inflator Assembly Handling	25
Figure 23. Weld Ball.....	25
Figure 24. Fabric Hose Subassembly Connection to Inflator Assembly (95).....	26
Figure 25. Squib Connector Subassembly Connection to Inflator Assembly (95).....	26
Figure 26. EMA (100) Aircraft Forward Orientation	29
Figure 27. X-Tree Clip (65) Installation	29
Figure 28. Cable Interface Assembly (55) Connection to the EMA (100)	29
Figure 29. EMA (100) LEDs.....	30
Figure 30. LED Cycles	30
Figure 31. Test Results	31
Figure 32. Connectors	31
Figure 33. Connectors - Locked Position.....	31
Figure 34. EMA and Aircraft LOPA	37
Figure 35. PTT Button	37
Figure 36. Diagnostic Results	38
Figure 37. Pairing Routing.....	38
Figure 38. Locked Connectors.....	38
Figure 39. Components.....	40
Figure 40. Connectors	42
Figure 41. Connectors - Unlocked Position.....	42
Figure 42. Squib Connector Subassembly Connection to Inflator Assembly (95).....	43
Figure 43. Weld Ball.....	43
Figure 44. Fabric Hose Subassembly Connection to Inflator Assembly (95).....	43
Figure 45. Inflator Assembly Handling	43
Figure 46. End Fitting on Connector Half (15 - 20)	44
Figure 47. Cable Interface Assembly (55) Connection to the EMA (100)	45
Figure 48. X-Tree Clip (65) Removal	45
Figure 49. 15-Pin and P2 and P3 Connectors on Cable Interface Assembly	47



1043 N. 47th Ave., Phoenix, AZ 85043 USA | www.amsafe.com
602-850-2850

SOARS Customer Service: SOARS@amsafe.com
SOARS Technical Support: SOARS_Support@amsafe.com

Figure 50. Inflator Assembly Handling51



LIST OF TABLES

Table 1. Acronyms and Abbreviations1

Table 2. SOARS Item No., Part No. and Nomenclature.....8

Table 3. Test Procedure and Limits.....33

Table 4. Fault Isolation Procedure34



1. Introduction

A. General

- (1) IM7336 provides information to perform all of the recommended installation procedures for the part number (herein referred to as the system) on the title page. Read IM7336 in its entirety. Refer to the table of contents for a list of topics. IM7336 will be revised as necessary.
- (2) Technical Standard Order Authorization
 - (a) The conditions and tests required for TSO approval of this article are minimum performance standards. It is the responsibility of those desiring to install the article either on or within a specific type or class aircraft to determine that the aircraft installation conditions are within the TSO standards. The article may be installed only if further evaluation by the applicant (user/installer) documents an acceptable installation and is approved by the Administrator.
- (3) Supplemental Type Certificate Limitations and Conditions
 - (a) This approval should not be incorporated in any aircraft unless it is determined that the interrelationship between this installation and any previous approved configuration will not introduce any adverse effect upon the airworthiness of the aircraft.

B. Associated Publications

- (1) Air Transport Association (ATA)
 - iSpec2200 (Information Standards for Aviation Maintenance)
- (2) AmSafe
 - E511885 (Inflatables Part Number Identification Specification)
- (3) Regulatory
 - AC 23.17C (Systems and Equipment Guide for Certification of Part 23 Airplanes and Airships)
 - AC 43.13-2B (Acceptable Methods, Techniques, and Practices - Aircraft Alterations)
 - 14 CFR §91.403 (General)
 - 49 CFR §172.301 (General Marking Requirements for Non-Bulk Packagings)
 - 49 CFR §172.400 (General Labeling Requirements)
 - 49 CFR §172.700 (Purpose and Scope)

C. Acronyms and Abbreviations

Table 1. Acronyms and Abbreviations

Acronym/Abbreviation	Name
AOG	Aircraft on Ground
ATA	Air Transport Association
CAGE	Commercial and Government Entity
CFR	Code of Federal Regulations
DOT	Department of Transportation
DOT-SP	DOT Special Provision
EMA	Electronic Module Assembly
EMI	Electromagnetic Interference
ERG	Emergency Response Guide



Table 1. Acronyms and Abbreviations

Acronym/Abbreviation	Name
lbf	pound-force
in-lb	inch-pound
LED	Light-Emitting Diode
LOPA	Layout of Passenger Accommodations
LRU	Line Replaceable Unit
mm	millimeter
PTT	Push-to-Test
RMA	Return Material Authorization
SDS	Safety Data Sheets
SOARS	State of the Art Restraint System
UN POP	United Nations Performance Oriented Packaging

2. Description and Operation

A. Description

- (1) The system (Figure 1) provides the seat occupant with protection from serious head-impact injury during a survivable aircraft crash and enhances the seat occupant's ability to egress the aircraft. The system does not interface to any aircraft systems, including the aircraft power supply.

NOTE: The inflatable restraint system assembly may be installed as a two-point restraint.

NOTE: The EMA, inflator assembly LRU/Inflator cable interface and cable interface assembly are not required equipment for the aircraft. Thus, the inflatable restraint system assembly may be used without the EMA, inflator assembly LRU/Inflator cable interface and cable interface assembly. Aircraft owners or operators should follow their procedure to placard the affected components as inoperable and may use SOARS as a restraint. However, all components of SOARS should be made operable as soon as possible.



Figure 1. System

- (2) The system consists of an inflatable restraint system assembly, cable interface assembly and LRU/inflator interface cable, inflator assembly and an electronic module assembly (EMA).
- (a) The inflatable restraint system assembly consists of three primary subassemblies: the connector half, the buckle half and the shoulder harness (Figure 2).
- 1 The connector half consists of a connector, adjuster assembly, 3-bar slide, webbing, air-bag, fabric hose subassembly and an end fitting (Figure 3). The buckle half consists of a buckle, 3-bar slide, webbing and an end fitting. The shoulder harness consists of an inertia reel, webbing and connector.
 - 2 The adjuster assembly and 3-bar slide adjust the webbing. The fabric hose subassembly attaches to the inflator assembly. The end fittings attach the connector half and buckle half to mounting points and the inertia reel attaches the shoulder harness to amounting point. The connector on the shoulder harness attaches to the rivet on the connector half.
- (b) The cable interface assembly (Figure 1) connects to the EMA and the LRU/inflator cable interface. The LRU/inflator cable interface also connects to the inflator assembly.

- (c) The inflator assembly mounts to the aircraft structure in a variety of locations (e.g., sidewall, underneath the seat or in the seatback). The inflator assembly contains compressed helium-argon gas.
- (d) The EMA is a device that senses a crash and sends a signal to deploy the airbag.



Figure 2. Connector Half, Buckle Half and Shoulder Harness

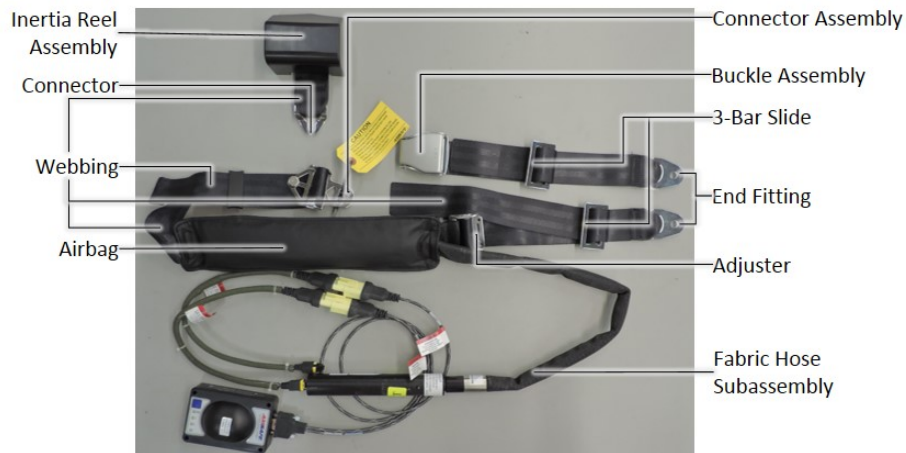

Figure 3. Connector Half, Buckle Half and Shoulder Harness

B. Safety Warnings and Cautions

WARNING: A WARNING CALLS ATTENTION TO MATERIALS, PROCESSES, METHODS, PROCEDURES OR LIMITS THAT MUST BE FOLLOWED TO AVOID INJURY TO PEOPLE.

CAUTION: A caution calls attention to materials, processes, methods, procedures or limits that must be followed to avoid damage to equipment.

(1) Read safety warnings and cautions prior to working on the system.

(2) Airbag

WARNING: THE SYSTEM IS ALWAYS LIVE AS SOON AS ALL ELECTRICAL CONNECTIONS ARE MADE. TO MINIMIZE THE RISK OF INJURY TO PEOPLE OR DAMAGE TO EQUIPMENT, KEEP THE SYSTEM BUCKLED WHEN THE SEAT IS NOT IN USE.

(3) EMA

WARNING: DO NOT DROP OR MISHANDLE THE EMA. DAMAGE TO THE ELECTRONICS, BATTERY OR SENSOR MAY OCCUR. IF THE EMA IS DROPPED OR DAMAGED THERE IS POTENTIAL FOR AN ANOMALY, SUCH AS NOT FUNCTIONING AS INTENDED OR DESIGNED. A DAMAGED OR MISHANDLED EMA COULD INJURE PEOPLE OR DAMAGE EQUIPMENT IF INSTALLED ON THE SEAT. IF DAMAGE OR MISHANDLING OCCURRED OR IS SUSPECTED, DO NOT INSTALL THE EMA. RETURN THE EMA TO AMSAFE FOR REPLACEMENT.

(4) Inflator Assembly

WARNING: THE INFLATOR ASSEMBLY CONTAINS COMPRESSED GAS. DEATH OR INJURY TO PEOPLE MAY OCCUR THROUGH MISUSE, MISHANDLING OR TAMPERING.

WARNING: DO NOT MISHANDLE OR TAMPER WITH THE INFLATOR ASSEMBLY IN ANY WAY. THE INFLATOR ASSEMBLY SHALL BE HANDLED AND STORED BY PEOPLE TRAINED IN THE REQUIREMENTS ASSOCIATED WITH DANGEROUS GOODS.

WARNING: DO NOT GRASP OR CARRY THE INFLATOR ASSEMBLY BY ITS DIFFUSER.

WARNING: NEVER ATTEMPT TO OPEN THE INFLATOR ASSEMBLY FOR SERVICING.

WARNING: NEVER PROBE OR APPLY ELECTRICAL CURRENT TO THE INFLATOR ASSEMBLY'S ELECTRICAL CONNECTIONS.

WARNING: KEEP THE INFLATOR ASSEMBLY AWAY FROM SOURCES OF THERMAL IGNITION, ELECTRIC SPARKS OR FLAME, IMPACT OR MECHANICAL IGNITION OR ELECTROSTATIC DISCHARGE. AUTOIGNITION MAY OCCUR WHEN THESE SOURCES ARE PRESENT AND MAY RESULT IN DEATH OR INJURY TO PEOPLE OR DAMAGE TO EQUIPMENT.

(a) Safety data sheets (SDS) are in ATTACHMENT A - ARC AUTOMOTIVE SDS.

(b) Do not grasp or carry the inflator assembly by its diffuser (Figure 4).

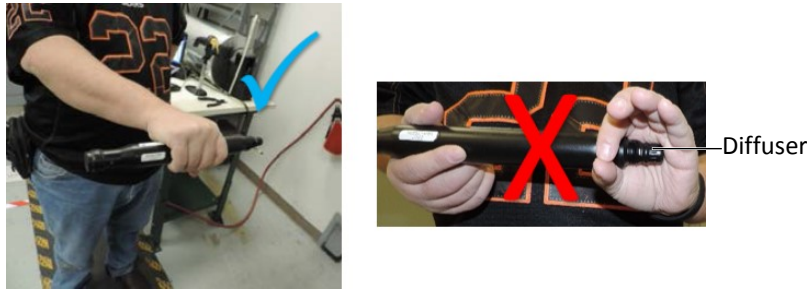

Figure 4. Inflator Assembly Handling

C. Course of Action for System Anomalies

WARNING: IN THE CASE OF A SYSTEM DEPLOYMENT, DO NOT USE ANY SEAT WITH A SYSTEM SHARING THE SAME EMA AS THE DEPLOYED SYSTEM. REMOVE AND RETURN ALL COMPONENTS TO AMSAFE.

- (1) In the rare case of an airbag deployment, do not use the system with the deployed airbag or any system with an airbag that is controlled by the same EMA as that of the deployed airbag.
- (2) Immediately remove and replace the system on the seat with the deployed airbag and any seat with an airbag that is controlled by the same EMA as that of the deployed airbag. (Refer to Removal and Installation.)
- (3) Do not keep or reuse components. Immediately return all components to AmSafe. (Refer to Storage.) Contact AmSafe Customer Service to submit a purchase order for replacement components.
- (4) Contact AmSafe Customer Service and provide the following information.
 - (a) When the airbag deployment occurred (e.g., during installation or during a diagnostic check).
 - (b) Damage to components (e.g., structures).
 - (c) Date, result and records of the last diagnostic test.
 - (d) Maintenance crew report (e.g., if brackets were properly secured or loose, if there were loose or broken connectors).
 - (e) Photos of components (e.g., brackets, deployed airbag, inflator assembly, fabric hose subassembly, EMA and cable interface assembly and LRU/inflator interface cable).
 - (f) Names of affected individuals and any injury claims.
 - (g) Contact information for flight or maintenance personnel.

3. Illustrated Parts List

A. General

- (1) Figure 5 provides the components in SOARS, Figure 6 provides the LOPA and Table 2 provides the item number, part number and nomenclature.

(2) Refer to AmSafe specification E511885 for part number identification.

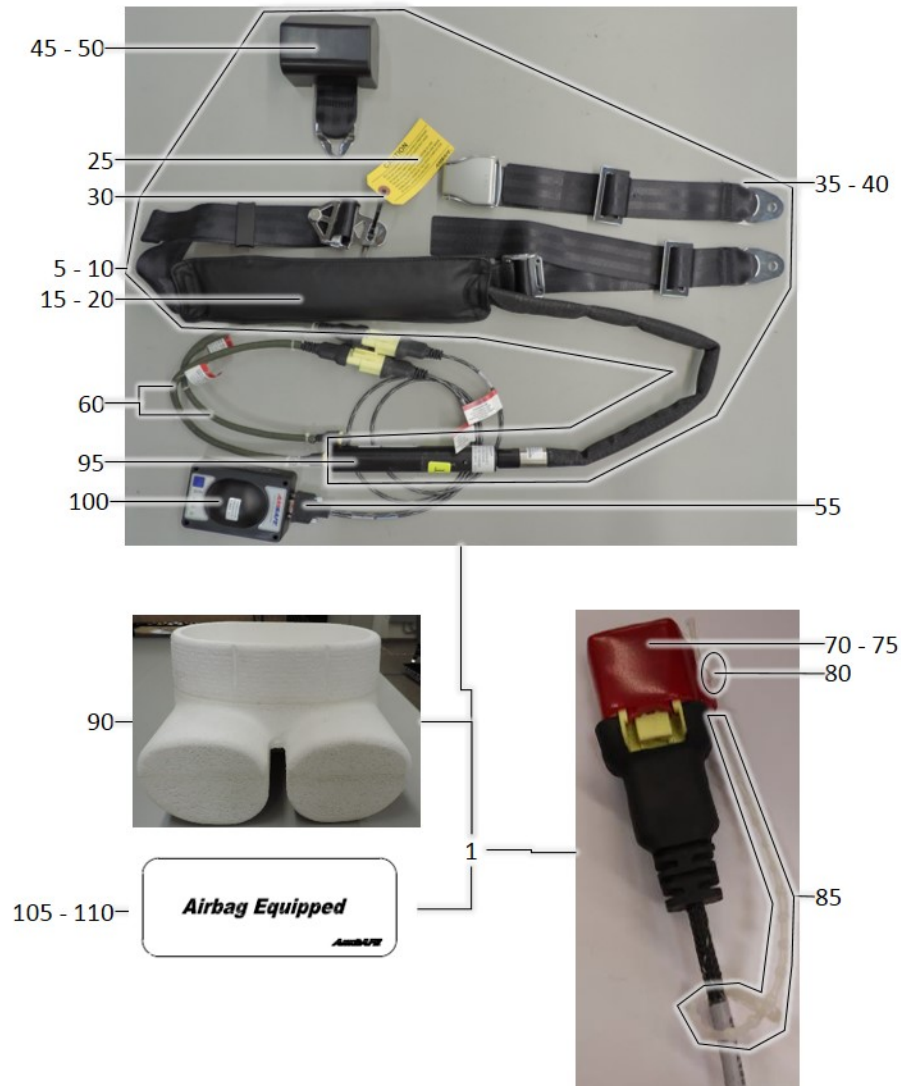

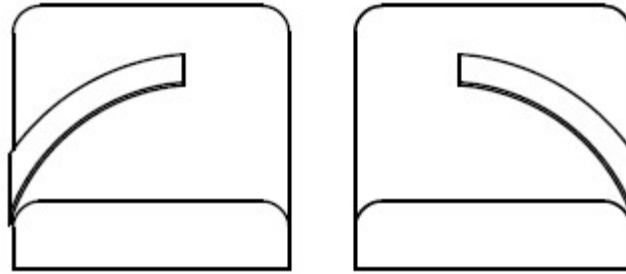

7336-1-011-2396 7336-1-021-2396

Figure 6. SOARS LOPA

Table 2. SOARS Item No., Part No. and Nomenclature

Item No.	Part No.	Nomenclature
1	K7336-201	INFLATABLE KIT ASSEMBLY
5	7336-1-011-2396	INFLATABLE RESTRAINT SYSTEM ASSEMBLY, LH
10	7336-1-021-2396	INFLATABLE RESTRAINT SYSTEM ASSEMBLY, RH
15	7336-2010112396	CONNECTOR HALF, LH
20	7336-2020212396	CONNECTOR HALF, RH
25	511006-3	INFLATABLE RESTRAINT CAUTION TAG
30	508298-3	STRAP, TIEDOWN, ELECTRICAL SPECIFICATION
35	7336-2030112396	BUCKLE HALF, LH
40	7336-2030212396	BUCKLE HALF, RH
45	7336-2050112396	SHOULDER HARNESS, LH
50	7336-2050212396	SHOULDER HARNESS, RH
55	513046-209-3636	CABLE INTERFACE ASSEMBLY
60	513047-405-18	LRU/INFLATOR CABLE INTERFACE
-65	510829-1	SINGLE X-TREE CLIP (OPTIONAL)
70	514387-1	ASSEMBLY, DUST CAP (FCI) (OPTIONAL)
75	514387-2	ASSEMBLY, DUST CAP (FCI) (OPTIONAL)
80	505098-7031	RETAINING WASHER (OPTIONAL)
85	505098-8069	BEADED NYLON CABLE TIE (OPTIONAL)
90	514480-1	BODY BLOCK
95	514519-401	INFLATOR ASSEMBLY, B0913400, EFM-01
100	514518-401-58	EMA
105	509121-1	AIRBAG EQUIPPED LABEL
110	509121-2	AIRBAG EQUIPPED LABEL
-Not illustrated		
<p>The dust cap, retaining washer and beaded nylon cable tie are optional components that are secured to the connectors on the cable interface assembly and LRU/inflator interface cable. The dust cap, retaining washer and beaded nylon cable tie are not supplied with inflatable kit assembly K7336 however, these components may be ordered from AmSafe.</p>		

4. Installation

A. Description

- (1) These installation procedures provide instructions to safely install the system and its components.
- (2) Contact for after-hours aircraft on ground (AOG): 602-432-6064.

B. Equipment and Materials

- (1) Use the following equipment and materials as required.

- Standard aviation tools
- Safety glasses
- Loctite 242

NOTE: Equivalent alternatives are permitted.

C. Criteria

- (1) Cable Interface Assembly (55) and LRU/Inflator Cable Interface (60)

- (a) The cable interface assembly (55) and LRU/inflator cable interface (60) restrict the possible mounting locations for the inflator assembly (95) and the EMA (100).
 - The squib connector must seat onto the inflator assembly (95) without strain or restriction.
 - The cable interface assembly (55) and LRU/inflator cable interface (60) must reach and connect to the EMA (100) without restriction or strain and provide the electrical connection to the inflator assembly (95).

- (b) The electrical connection of the squib connector onto the inflator assembly (95) must remain secure, easily accessible, and not strained or restricted by seat movement.

- (2) Fabric Hose Subassembly

- (a) The fabric hose subassembly restricts possible mounting locations for the inflator assembly (95). Proper routing of the fabric hose subassembly must be observed to allow gas to flow unrestricted to the airbag to obtain the desired performance during system activation.
- (b) The outside diameter of an inflated fabric hose subassembly is 0.75 in (1.90 cm). Allow space between rigid objects to allow for expansion of the fabric hose subassembly during system activation. In general, if there is enough room for the gas hose barb on the end of the fabric hose subassembly to fit, there is enough space for fabric hose subassembly to inflate.
- (c) Ensure there is 2.00 in (5.08 cm) of slack in the fabric hose subassembly to allow stretching.
- (d) The fabric hose subassembly should be routed in a manner that minimizes bending and twisting. The fabric hose subassembly can function properly with up to two, 90-degree bends.
- (e) Slight pressure against the fabric hose subassembly, due to cushions or other non-rigid objects pressing against the fabric hose subassembly, is allowed. The fabric hose subassembly will expand and move the cushion out of the way.
- (f) Installation of plastic clips to route the fabric hose subassembly is acceptable, as long as they allow the fabric hose subassembly to expand when the system is activated.

- (g) Sharp edges that could potentially cause wear to the fabric hose subassembly should be covered.
 - (h) For seats with a seat track that allows horizontal and vertical movement of the seat, the inflator assembly's (95) mounting position must allow for full forward and full backward seat movement such that the fabric hose subassembly is not pinched, twisted, or its functioning is not restricted or compromised.
- (3) Inflator Assembly (95)
- (a) The inflator assembly (95) is 8.37 in (21.25 cm) long and 1.25 in (3.17 cm) wide.
 - (b) The inflator assembly (95) and any inflator bracket must be mounted and designed to withstand the static inertia loads corresponding to the following ultimate load factors: upward 3.0g, forward 18.0 g, and sideward 4.5 g. Gas deployment does not impose any appreciable loads on the inflator assembly (95) mounting brackets. Mounting brackets that are made strong enough to withstand the aforementioned structural requirements will be strong enough to withstand any loads imposed by the inflator assembly's (95) gas deployment.
 - (c) The inflator assembly (95) can be mounted in any orientation and at any location where there is space (subject to the length limitations of the fabric hose subassembly).
 - 1 If the mounting point on the inflatable restraint system assembly (5 - 10) is on the seat, it is usually best to mount the inflator assembly (95) to the underside of the seat for the inflator assembly (95) and seatbelt mounting points to translate as the seat position is changed.
 - 2 If the inflatable restraint system assembly (5 - 10) mounting points are to the aircraft, it is usually best to mount the inflator assembly (95) to the aircraft near the inflatable restraint system assembly (5 - 10) mounting points.
 - (d) The inflator assembly (95) does not produce any electromagnetic fields. The inflator assembly's (95) mounting location should not be constrained by location to motors or other components emitting or affected by electromagnetic interference (EMI).
 - (e) Installation of inflator assembly (95) brackets should be documented on FAA Form 337, Major Repair and Alteration.
- (4) EMA (100)
- (a) The EMA's (100) dimensions are in Figure 7.
 - (b) The EMA (100) restrictions are as follows.
 - A physical and line of site access to the push-to-test button during installation and maintenance.
 - Access to the 15-pin connector.
 - A 2.00 in (5.08 cm) stay out zone between the EMA (100) and any equipment that produces a measurable magnetic field. In the event that the 2.00 in (5.08 cm) stay out zone is violated, encroaching components shall not generate a magnetic field higher than 5.0 gauss.
 - A 0.50 in (1.27 cm) mandatory stay out zone between the EMA (100) and equipment that produces any measurable magnetic field shall not be violated. The 0.50 in (1.27 cm) stay out zone limitation is necessary to assure the magnetic protection sensors are not adversely affected.

- (c) The EMA (100) must face aircraft forward (Figure 8) and along the longitudinal axis of the aircraft. A manufacturing and mounting tolerance of ± 3 degrees from the longitudinal axis in both pitch and yaw is allowed.
- (d) Access to components for removal and replacement should be considered for the location of mounting brackets (if used) and EMA (100).
- (e) The EMA (100) must mount to a rigid aircraft structure.
- (f) The EMA (100) is vibration-sensitive and must be mounted on rigid aircraft structure to properly transmit the crash pulse and to minimize the effects of vibration on the EMA (100).
- (g) The EMA (100) may be mounted to airframe structure without brackets if the orientation and stiffness requirements are met.
- (h) The EMA (100) mounting brackets must meet the following criteria.
 - The mounting bracket shall be mounted to primary aircraft load-carrying structures such as trusses, bulkheads, longerons, spars or floor beams (not aircraft skin).
 - The mounts shall have a maximum static local deflection no greater than 0.05 in (0.13 cm) when a force of 450 Newtons (100 lbf) is applied to the mount in the most flexible direction.
 - Deflection measurements shall be made with reference to another part of the airframe not less than 1 ft (0.3 m) nor more than 3 ft (1.0 m) from the mounting location.
 - The mounting bracket must be fabricated to accept four through-bolts (Figure 9) used to secure the EMA (100) to the mounting bracket.
 - The mounting bracket must be mounted and designed to withstand the static inertia loads corresponding to the following ultimate load factors: upward 3.0g, forward 18.0g, and sideward 4.5g.
 - Aircraft maintenance manuals should include instruction to inspect the EMA bracket for damage (e.g., cracks and dents) and to remove and replace a damaged EMA bracket.
- (i) The EMA (100) must be mounted within the length limit of the cable interface assembly (55) to make the electrical connection. Arrows located on the EMA (100) label give the aircraft forward direction.
- (j) The EMA (100) is not affected by EMI and does not produce electromagnetic fields. The EMA's (100) mounting location should not be constrained by location to motors or other components emitting or affected by EMI.
- (k) Installation of mounting brackets should be documented on FAA Form 337, Major Repair and Alteration.

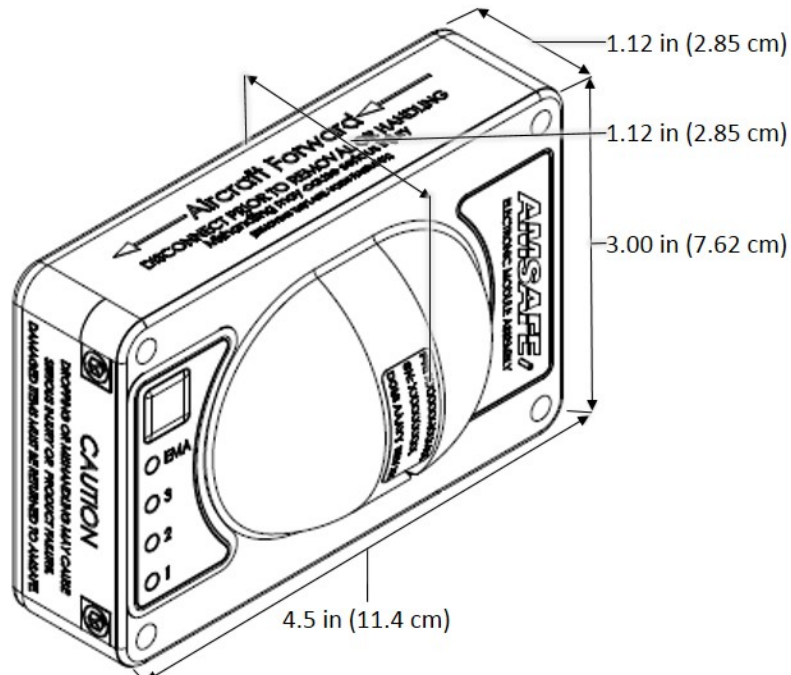

Figure 7. EMA (100) Dimensions



Figure 8. EMA (100) Aircraft Forward Label



Figure 9. EMA (100) Bolt Holes

D. Procedure

NOTE: This procedure is for the initial installation of the system (1) onto the seat. Refer to ICA7336 for instructions for continued airworthiness.

NOTE: This procedure is for the initial installation of the inflatable restraint system assembly (5 - 10) at the midway point of the seat and addresses the full range of seat occupants from the 5th percentile female to the 95th percentile male.

NOTE: In aircraft originally manufactured (certified) with two-point restraints, SOARS may be installed as a two-point restraint.

NOTE: In aircraft originally manufactured (certified) with three- or four- or five-point restraints, the same restraint must be installed for the three- or four- or five-point restraints to use the existing brackets in these aircraft.

WARNING: **THE SYSTEM (1) IS ALWAYS LIVE AS SOON AS ALL ELECTRICAL CONNECTIONS ARE MADE. TO MINIMIZE THE RISK OF INJURY TO PEOPLE OR DAMAGE TO EQUIPMENT, KEEP THE SYSTEM (1) BUCKLED WHEN THE SEAT IS NOT IN USE.**

(1) Installation consists of the following steps.

- (a) Review the criteria in paragraph C and ensure the criteria (e.g., adequate space, accessibility and bracket design) are met. Refer to step 2.
- (b) Read all installation procedures before proceeding. Refer to step 3.
- (c) Install the connector half (15 - 20), buckle half (35 - 40) and shoulder harness (45 - 50) (Figure 10). Refer to step 4.
- (d) Install the inflator assembly (95) (Figure 10, Figure 22 and Figure 23). Refer to step 5.
- (e) Install the fabric hose subassembly and secure the inflator assembly (95). Refer to step 6.
- (f) Install the EMA (100), EMA bracket, cable interface assembly (55) and LRU/inflator cable interface (60). Refer to step 7.
- (g) Peel the backing off of the airbag-equipped label (105 - 110) and affix the label (105 - 110) to the aircraft window. Refer to step 8.
- (h) Perform a functional test. (Refer to Testing and Fault Isolation). Refer to step 9.

(2) Review the criteria in paragraph C and ensure the criteria (e.g., adequate space, accessibility and bracket design) are met.

(3) Read all installation procedures before proceeding.

(4) Install the connector half (15 - 20), buckle half (35 - 40) and shoulder harness (45 - 50) (Figure 10).

WARNING: **THE SYSTEM (1) IS ALWAYS LIVE AS SOON AS ALL ELECTRICAL CONNECTIONS ARE MADE. TO MINIMIZE THE RISK OF INJURY TO PEOPLE OR DAMAGE TO EQUIPMENT, KEEP THE SYSTEM (1) BUCKLED WHEN THE SEAT IS NOT IN USE.**

WARNING: **UNINTENTIONAL DEPLOYMENT OF THE AIRBAG COULD OCCUR IF COMPONENTS ARE REPLACED OUT OF SEQUENCE. UNINTENTIONAL DEPLOYMENT OF THE AIRBAG COULD INJURE PEOPLE OR DAMAGE EQUIPMENT.**

- (a) Unwrap the connector half (15 - 20), buckle half (35 - 40) and shoulder harness (45 - 50). Remove and discard the cable tie (30) and caution tag (25) on the connector half (15 - 20).

- (b) Secure the end-fitting on the buckle half (35 - 40) to the mounting point.

NOTE: There is a left-hand buckle half (35) and a right-hand buckle half (40). Install the correct buckle half (35 - 40). Refer to the ILLUSTRATED PARTS LIST.

NOTE: The buckle half (35 - 40) can be mounted to the original mounting point. If the original mounting point is not used, the buckle half (35 - 40) can be mounted to the seat, floor or aircraft structure.

NOTE: If necessary, secure a bushing between the mounting point and the end fitting.

NOTE: Use the hardware provided by the aircraft owner/operator.

- (c) Secure the end-fitting on the connector half (15 - 20) to the mounting point.

NOTE: There is a left-hand connector half (15) and a right-hand connector half (20). Install the correct connector half (15 - 20). Refer to the ILLUSTRATED PARTS LIST.

NOTE: The connector half (15 - 20) can be mounted to the original mounting point. If the original mounting point is not used, the connector half (15 - 20) can be mounted to the seat (Figure 11), floor or aircraft structure.

NOTE: If necessary, secure a bushing between the mounting point and the end fitting.

NOTE: Use the hardware provided by the aircraft owner/operator.

NOTE: The airbag on the connector half (15 - 20) must present away from the seat occupant with the warning label oriented on the inside of the airbag and towards the seat occupant. The warning label must be right-side up when viewed by the seat occupant.

- (d) Secure the inertia reel on the shoulder harness (45 - 50) to the mounting point.

NOTE: Skip this step if the inflatable restraint system assembly (5 - 10) is installed as a two-point restraint.

NOTE: There is a left-hand shoulder harness (45) and a right-hand shoulder harness (50). Install the correct shoulder harness (45 - 50). Refer to the ILLUSTRATED PARTS LIST.

1 If necessary, remove the cover on the inertia reel.

2 Secure the inertia reel on the shoulder harness (45 - 50) to the mounting point.

NOTE: If necessary, use a bushing to secure the inertia reel.

NOTE: Use the hardware provided by the aircraft owner/operator to install the shoulder harnesses (45 - 50).

a The shoulder harness (45 - 50) can be secured to the original mounting point. If the original mounting point is not used (the webbing may be too short) the shoulder harness (45 - 50) can be mounted at the D-ring.

b In the case of a two-point to a three-point retrofit installation the mounting point may be installed by the following options.

(1) Operator designed per AC 43.13-2A requirements.

(2) By use of existing third party STC-approved shoulder harness (45 - 50) mounting point kit (if available).

(3) If a third-party mounting point for the shoulder harness (45 - 50) is used, it

is the responsibility of the installer to ensure it is compatible with the restraint system (5 - 10). Accordingly, the mounting point for the shoulder harness (45 - 50) would be acceptable if installed per AC43.13-2B guidelines by the following options.

- (a) FAA Form 337, Major Repair and Alteration.
- (b) For airplanes in which the original certification basis of the airplane did not require the installation of a shoulder harnesses (45 - 50): by minor change and log book entry in accordance with FAA Advisory Circular AC 23.17C, paragraph 23.785.

3 Secure the cover on the inertia reel.

(e) Ensure the seat is in the center position of the horizontal and vertical adjustment.

(f) Align the connector half (15 - 20) and buckle half (35 - 40).

NOTE: This procedure is for the initial installation on the seat at the midway point of the seat and addresses the full range of seat occupants from the 5th percentile female to the 95th percentile male. It is not necessary to repeat step f through step h after the initial installation on the seat if the seat occupant exceeds the 5th percentile female to the 95th percentile male.

NOTE: The figures referenced in step f through step h are representative and show mounting points on the seat. The actual mounting points may be to the seat, floor or aircraft structure.

WARNING: THE SHAPE OF THE BODY BLOCK (90) ENSURES PROPER ALIGNMENT AND INSTALLATION. DO NOT USE THE BODY BLOCK (90) IF IT IS DAMAGED (E.G., CRACKS, TEARS, HOLES, DENTS OR MISSING PIECES).

1 Ensure the body block (90) is not damaged (e.g., cracks, tears, holes dents or missing pieces).

2 Place the body block (90) on the center of the seat and flat against the seat's bottom and back cushions (Figure 12).

NOTE: Ensure the body block (90) is centered on the seat and against the seat's bottom and back cushions at all times the body block (90) is in use.

3 Place the connector half (15 - 20) around the pelvis on the body block (90) (Figure 13).

4 Secure the connector half (15 - 20).

a Remove the webbing from the 3-bar-slide on the connector half (15 - 20) until one layer of webbing remains in the 3-bar slide and the 3-bar slide moves easily along the length of the webbing (Figure 14).

NOTE: Do not completely remove the webbing from the 3-bar slide.

b Align the leading edge of the airbag cover (the edge near the connector) with the inboard groove on the body block (90) (Figure 15).

c Simultaneously hold the airbag against the body block (90) and pull the free end of the webbing until the connector half (15 - 20) is snug against the body block (90).

d If necessary, repeat steps step b and step c until the leading edge of the airbag cover aligns with the inboard groove on the body block (90).

- e Thread the loose end of the webbing through and around the 3-bar slide until the webbing is snug around the 3-bar slide (Figure 16).
- 5 Secure the buckle half (35 - 40).
 - a Buckle the connector half (15 - 20) and buckle half (35 - 40).
 - NOTE:** Ensure the connector half (15 - 20) and buckle half (35 - 40) are not twisted.
 - NOTE:** Ensure the leading edge of the airbag cover (the edge near the connector) aligns with the inboard groove on the body block (90).
 - b Remove the webbing from the 3-bar-slide on the buckle half (35 - 40) until one layer of webbing remains in the 3-bar slide and the 3-bar slide moves easily along the length of the webbing (Figure 17).
 - c Adjust the location of the buckle assembly until it is on the side of the hip on the body block (90) (Figure 18).
 - d Simultaneously hold the airbag against the body block (90) and pull the free end of the webbing near the connector until the connector half (15 - 20) and buckle half (35 - 40) are snug against the body block (90).
 - e Unbuckle the connector half (15 - 20) and buckle half (35 - 40).
 - f Place the 3-bar slide 2 in (5.08 cm) or more from the buckle assembly (Figure 19).
 - g Thread the loose end of the webbing over and through the end of the 3-bar slide and then through the 3-bar slide (Figure 20).
 - h Ensure the webbing on the 3-bar slide is snug.
- 6 Remove the body block (90).
 - (g) Buckle the connector half (15 - 20) and buckle half (35 - 40).
 - (h) Attach the connector on the shoulder harness (45 - 50) to the rivet on the connector half (15 - 20) (Figure 21).
 - NOTE:** Skip this step if the system was installed as a two-point restraint.

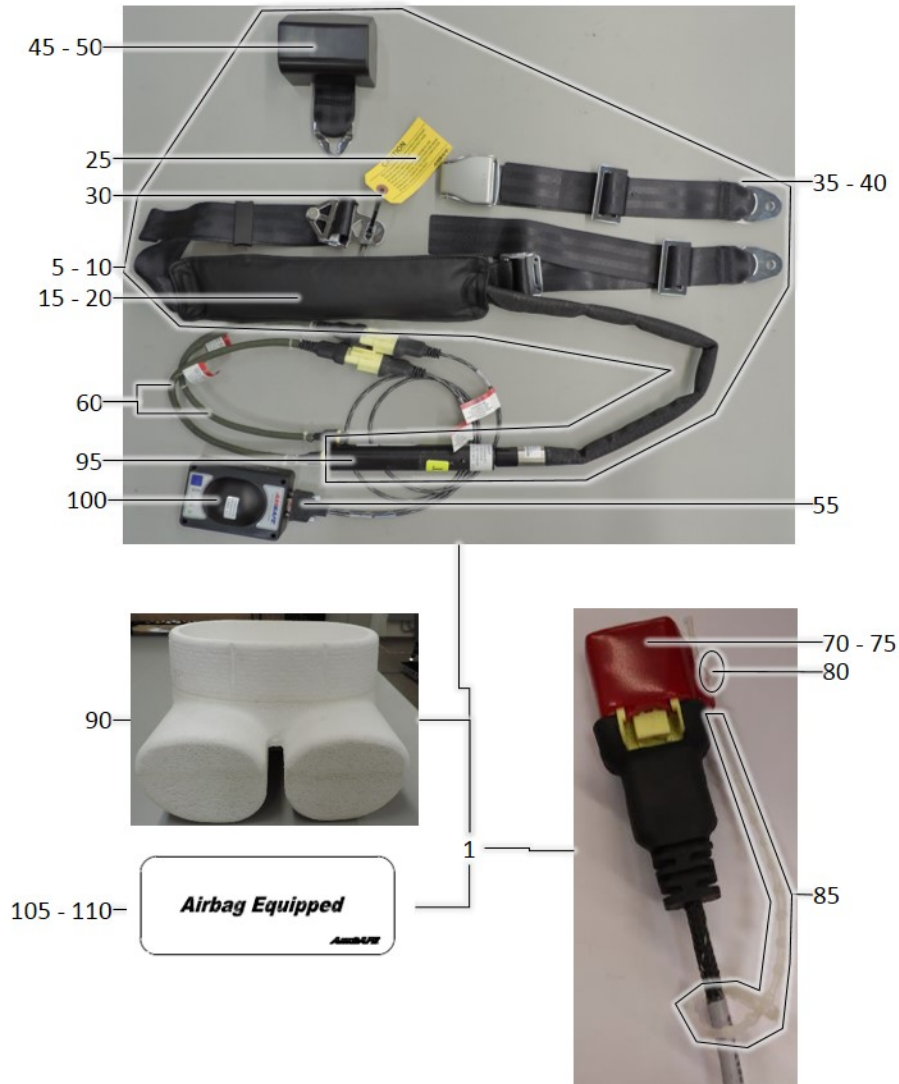



Figure 12. Body Block (90) Placement



Figure 13. Connector Half (15 - 20) On Body Block (90)

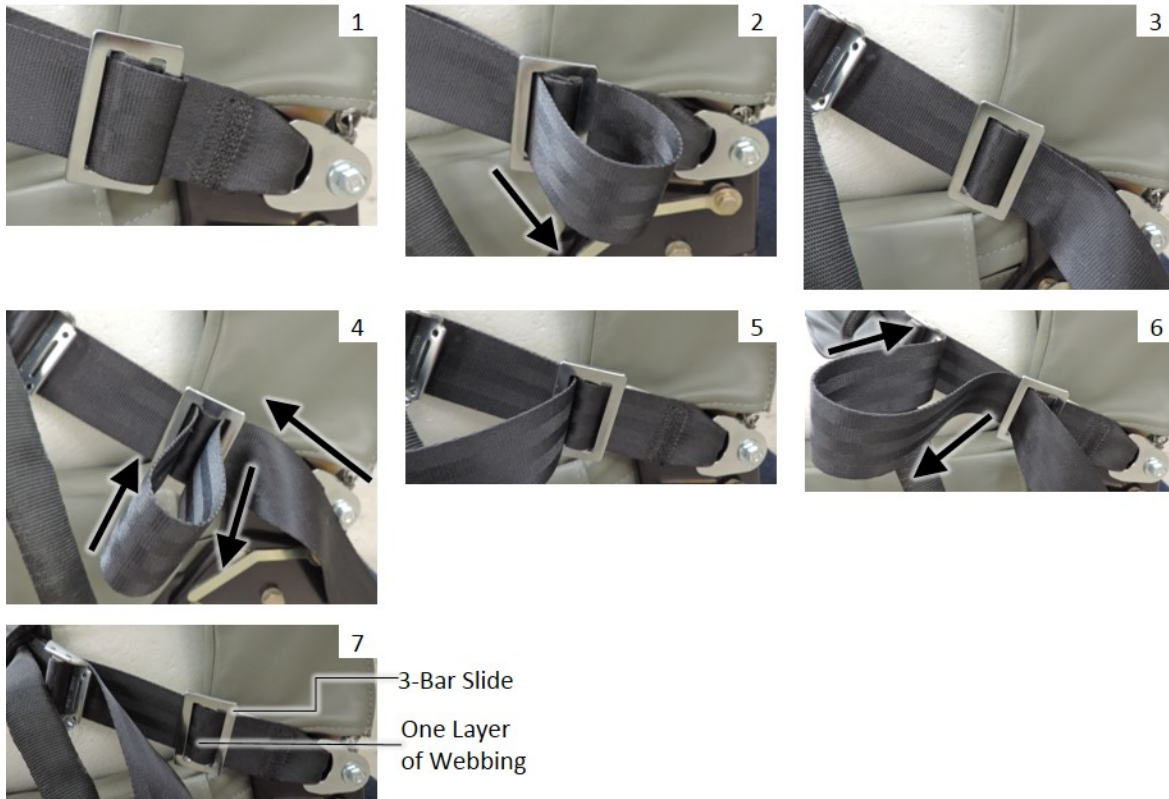

Figure 14. Removing the Webbing From the 3-Bar Slide



Figure 15. Airbag Cover Alignment on Body Block (90)

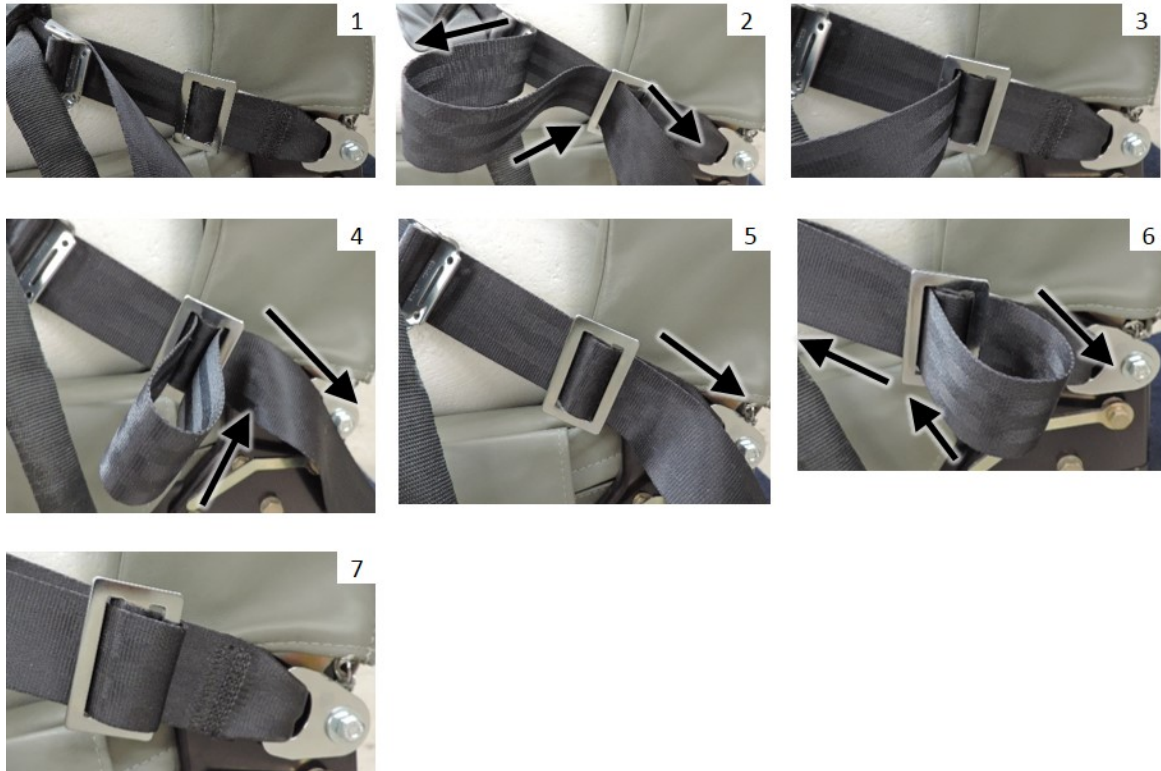

Figure 16. Threading Webbing Through the 3-Bar Slide

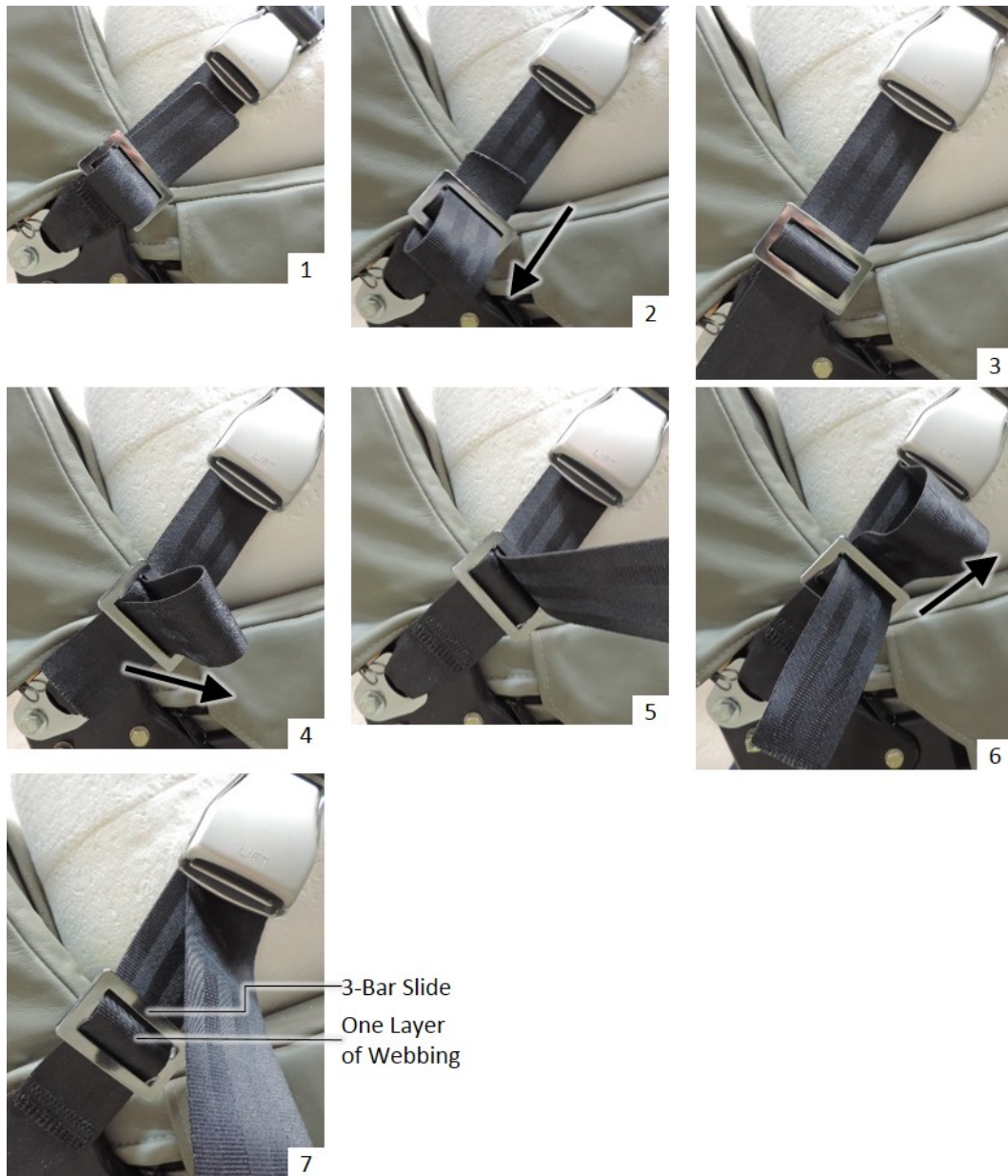

Figure 17. Removing the Webbing on the 3-Bar Slide

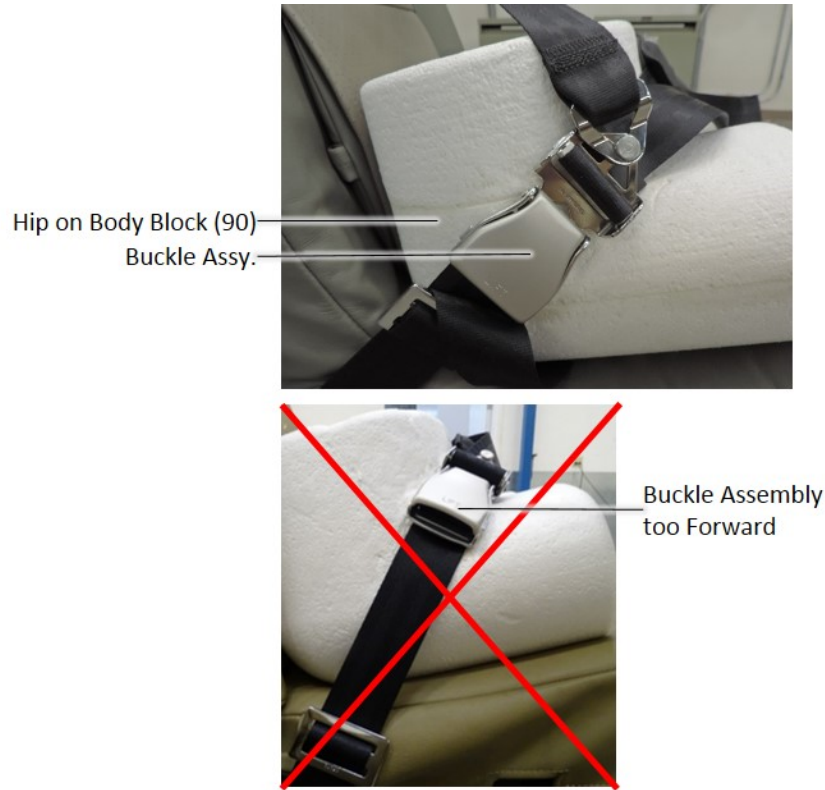

Figure 18. Location of Buckle Assembly



Figure 19. Distance Between 3-Bar Slide and Buckle Assembly

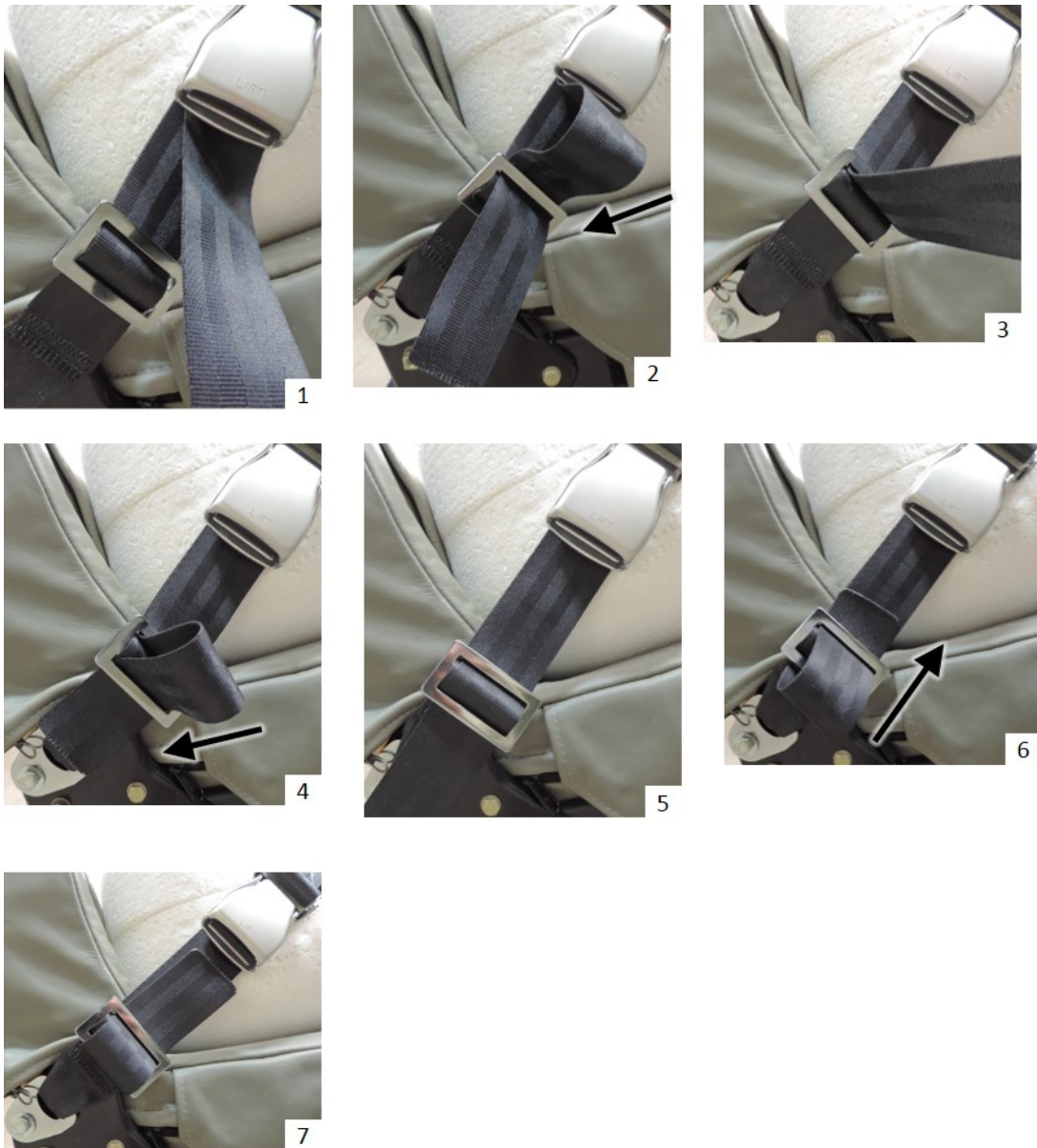

Figure 20. Threading Webbing Through 3-Bar Slide



Figure 21. Connector Attached to Rivet

- (5) Install the inflator assembly (95) (Figure 10, Figure 22 and Figure 23).

WARNING: THE INFLATOR ASSEMBLY (95) CONTAINS COMPRESSED GAS. DEATH OR INJURY TO PEOPLE OR DAMAGE TO EQUIPMENT MAY RESULT FROM MISUSE, MISHANDLING OR TAMPERING.

WARNING: IF THE INFLATOR ASSEMBLY (95) IS NOT SECURED AND THE INFLATOR ASSEMBLY (95) IS UNINTENTIONALLY DEPLOYED, THE COMPRESSED GAS MAY CAUSE DEATH OR INJURY TO PEOPLE OR DAMAGE TO EQUIPMENT.

WARNING: DO NOT GRASP OR CARRY THE INFLATOR ASSEMBLY (95) BY ITS DIFFUSER.

WARNING: DO NOT MISHANDLE OR TAMPER WITH THE INFLATOR ASSEMBLY (95) IN ANY WAY. THE INFLATOR ASSEMBLY (95) SHALL BE HANDLED AND STORED BY PEOPLE TRAINED IN THE REQUIREMENTS ASSOCIATED WITH DANGEROUS GOODS.

WARNING: NEVER ATTEMPT TO OPEN THE INFLATOR ASSEMBLY (95) FOR SERVICING.

WARNING: NEVER PROBE OR APPLY ELECTRICAL CURRENT TO THE INFLATOR ASSEMBLY'S (95) ELECTRICAL CONNECTIONS.

WARNING: DO NOT CLAMP OVER, BIND AGAINST, OR TORQUE AGAINST THE WELD BALL ON THE INFLATOR ASSEMBLY (95). DAMAGE TO THE WELD BALL IS A POTENTIAL SAFETY HAZARD.

WARNING: ENSURE THE INFLATOR ASSEMBLY (95) IS INSTALLED TO ENSURE IT WILL NOT TRANSLATE IN THE EVENT IT IS UNINTENTIONALLY DEPLOYED. IF THE INFLATOR ASSEMBLY (95) IS UNINTENTIONALLY DEPLOYED, THE COMPRESSED GAS MAY CAUSE DEATH OR INJURY TO PEOPLE OR DAMAGE TO EQUIPMENT.

- (a) Install the inflator assembly (95). If used, ensure the inflator assembly (95) is contained within the mounting bracket. Do not handle the inflator assembly (95) by its diffuser.

NOTE: Do not fully tighten the inflator assembly (95) at this time.

NOTE: Do not damage the serial number on the inflator assembly (95) when mounting.

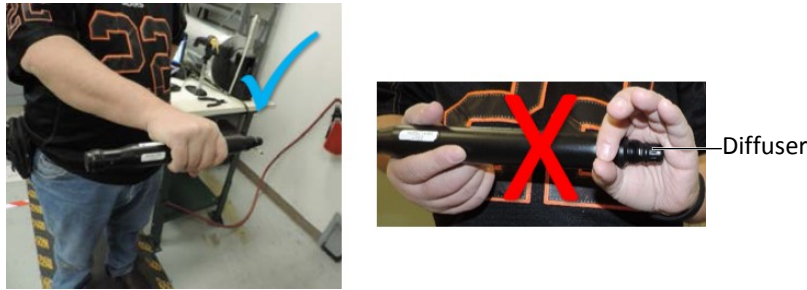

Figure 22. Inflater Assembly Handling



Figure 23. Weld Ball

- (6) Install the fabric hose subassembly and secure the inflator assembly (95).
- (a) Route the fabric hose subassembly such that there are no twists and no more than two, 90-degree bends.
 - (b) Secure the fabric hose subassembly using hardware.
 - (c) Remove the cap plug from the fabric hose subassembly.
- WARNING: DO NOT CLAMP OVER, BIND AGAINST, OR TORQUE AGAINST THE WELD BALL ON THE INFLATOR ASSEMBLY (95). DAMAGE TO THE WELD BALL IS A POTENTIAL SAFETY HAZARD.**
- CAUTION:** Do not use pliers to secure the fabric hose subassembly to the inflator assembly (95) as they may damage the fabric hose subassembly.
- CAUTION:** Use only soft-jaw pliers or a strap wrench. Do not damage the end of the fabric hose subassembly or the inflator assembly (95).
- (d) Secure the fabric hose subassembly to the inflator assembly (95) (Figure 24).
- NOTE:** Ensure the fabric hose subassembly is fully seated onto the inflator assembly (95).
- 1 Apply 2-3 drops of thread-locking compound in a thin, even coat onto the threaded end of the inflator assembly (95).
 - 2 Secure the inflator assembly (95) to the fabric hose subassembly by rotating the inflator assembly (95).
 - 3 Torque the fabric hose subassembly onto the inflator assembly (95) 60±10 in-lb.
- NOTE:** If it is not possible to perform step 3 with the inflator assembly (95) partially secured, follow the below steps.
- a Remove the inflator assembly (95) and secure the inflator assembly (95) to the fabric hose subassembly.

- b** Torque the fabric hose subassembly onto the inflator assembly (95) 60±10 in-lb and reinstall the inflator assembly (95).
- (e)** Secure the inflator assembly (95) so that the inflator assembly (95) cannot move.
- (f)** Seat the squib connector subassembly on the LRU/inflator cable interface (60) to the inflator assembly (95) until the squib connector subassembly locks into place (Figure 25).

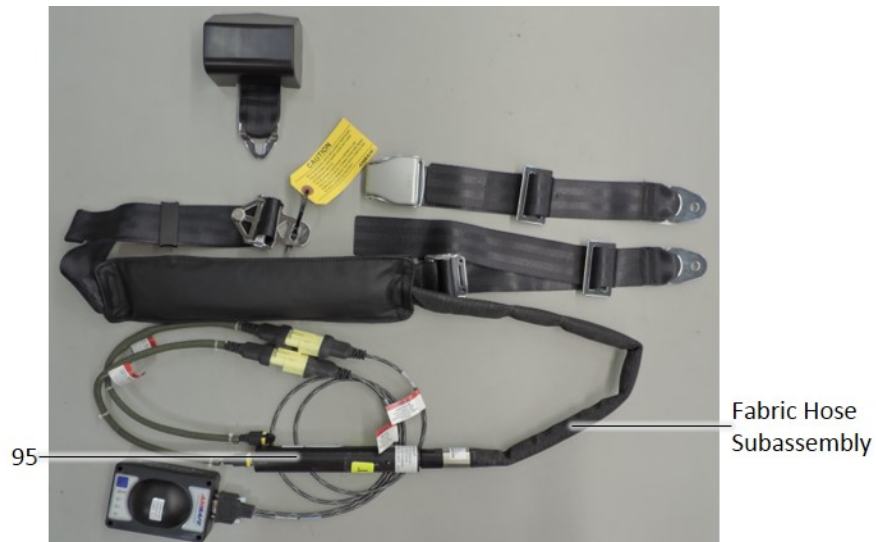

Figure 24. Fabric Hose Subassembly Connection to Inflator Assembly (95)

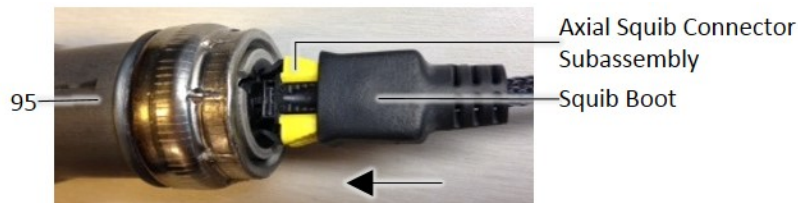

Figure 25. Squib Connector Subassembly Connection to Inflator Assembly (95)

- (7)** Install the EMA (100), EMA bracket, cable interface assembly (55) and LRU/inflator cable interface (60).

WARNING: DO NOT DROP OR MISHANDLE THE EMA (100). DAMAGE TO THE ELECTRONICS, BATTERY OR SENSOR MAY OCCUR. IF THE EMA (100) IS DROPPED OR DAMAGED THERE IS THE POTENTIAL FOR AN ANOMALY, SUCH AS NOT FUNCTIONING AS INTENDED OR DESIGNED. A DAMAGED OR MISHANDLED EMA (100) COULD INJURE PEOPLE OR DAMAGE EQUIPMENT IF INSTALLED ON THE SEAT. IF DAMAGE OR MISHANDLING HAS OCCURRED OR IS SUSPECTED, DO NOT INSTALL THE EMA (100). RETURN THE EMA (100) TO AMSAFE FOR REPLACEMENT.

WARNING: ENSURE THE EMA (100) IS SECURED TO PREVENT UNINTENTIONAL DEPLOYMENT OF THE AIRBAG. UNINTENTIONAL DEPLOYMENT OF THE AIRBAG MAY INJURE PEOPLE OR DAMAGE EQUIPMENT.

(a) Install the EMA bracket to a primary aircraft load-carrying structure.

NOTE: Skip the above step if an EMA bracket is not used.

(b) Orient the EMA (100) aircraft forward (Figure 26) and install the EMA (100) using four fasteners. Torque fasteners 30±2 in-lb.

NOTE: The top of the fasteners should be flush with the top of the EMA (100). If necessary, exceed the initial torque value.

(c) Install the cable interface assembly (55) and LRU/inflator cable interface (60).

WARNING: THE LAST ELECTRICAL CONNECTIONS ARE TO THE P2 AND P3 CONNECTORS ON THE CABLE INTERFACE ASSEMBLY (55). THESE CONNECTIONS ARE MADE ONLY AFTER INSTALLATION OF ALL COMPONENTS.

1 Route and secure the cable interface assembly (55).

NOTE: Ensure the cable interface assembly (55) does not have pinch points caused by seat movement.

a If desired, install the dust cap (70) to the cable interface assembly (55).

(1) Wrap the cable tie (85) around the cable interface assembly (55), thread the cable tie (85) through its end opening and it into place.

(2) Thread the free end of the cable tie (85) through the hole in the dust cap (70).

(3) Slide and secure the retaining washer (80) to the end of the cable tie (85).

2 Route and secure the LRU/inflator cable interface (60).

NOTE: Ensure the LRU/inflator cable interface (60) does not have pinch points caused by seat movement.

a Using needle-nose pliers, secure an x-tree clip (65) to the LRU/inflator cable interface (60) by pushing it into the P1 connector (Figure 27). Do not damage the end of the connector.

b If desired, install the dust cap (75) to the LRU/inflator cable interface (60).

(1) Wrap the cable tie (85) around the LRU/inflator cable interface (60), thread the cable tie (85) through its end opening and it into place.

(2) Thread the free end of the cable tie (85) through the hole in the dust cap (75).

(3) Slide and secure the retaining washer (80) to the end of the cable tie (85).

WARNING: ENSURE MATING INTERFACES ARE PARALLEL AND ON CENTER WHEN CONNECTING OR DISCONNECTING THE 15-PIN CONNECTOR ON THE CABLE ASSEMBLY INTERFACE (55) TO THE EMA (100). IF MISALIGNED CONNECTORS ARE MATED OR FORCED TOGETHER, DAMAGE TO THE 15-PIN CONNECTOR COULD OCCUR AND COULD LEAD TO UNINTENTIONAL DEPLOYMENT OF COMPRESSED GAS THAT MAY INJURE PEOPLE OR DAMAGE EQUIPMENT.

(d) Check for any debris or damage to the 15-pin connector (P1), (Figure 28).

(e) Connect the 15-pin connector (P1) to the EMA (100).

NOTE: Ensure there is no resistance when connecting the 15-pin connector (P1) to the EMA (100).

(f) Torque the thumb screws 6 ± 2 in-lb.

NOTE: If connecting the 15-pin connector to the EMA (100) is a blind connection, or is difficult to make and a proper connection cannot be assured, follow the below steps.

1 Ensure the P2 and P3 connectors on the cable interface assembly (55) are disconnected. If the P2 and P3 connectors are connected, disconnect them by sliding the red tab on the connector backwards to the unlocked position, depressing the yellow tab and then pulling the connectors apart.

2 If necessary, remove the EMA (100) (for clear visual access.)

3 Connect the 15-pin connector (P1) to the EMA (100).

NOTE: Ensure there is no resistance when connecting the 15-pin connector (P1) to the EMA (100).

4 Torque the thumb screws 6 ± 2 in-lb.

5 Reinstall the EMA (100).

(g) Check the EMA (100) for mishandling.

1 Find the LEDs on the EMA (100) (Figure 29).

2 Push the PTT button on the EMA (100) (Figure 30).

3 Passing results are in Figure 31. If the test failed, remove the EMA (100) (refer to Removal) and install a new EMA (100).

WARNING: THE LAST ELECTRICAL CONNECTIONS ARE TO THE P2 AND P3 CONNECTORS ON THE CABLE INTERFACE ASSEMBLY (55). THESE CONNECTIONS ARE MADE ONLY AFTER INSTALLATION OF ALL COMPONENTS.

WARNING: ENSURE THE EMA (100) IS SECURED TO PREVENT UNINTENTIONAL DEPLOYMENT OF THE AIRBAG. UNINTENTIONAL DEPLOYMENT OF THE AIRBAG MAY INJURE PEOPLE OR DAMAGE EQUIPMENT.

(h) Connect each P2 and P3 connector on the cable interface assembly (55) (Figure 32) to the connector on the LRU/inflator cable interface (60). Lock connectors by sliding the red tab forward (Figure 33). The red tab will not engage unless connectors are fully seated.



Figure 26. EMA (100) Aircraft Forward Orientation



Figure 27. X-Tree Clip (65) Installation

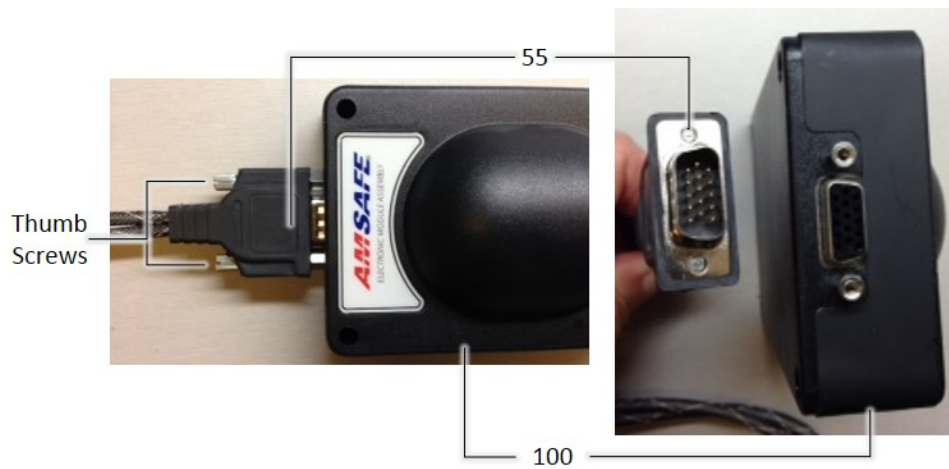
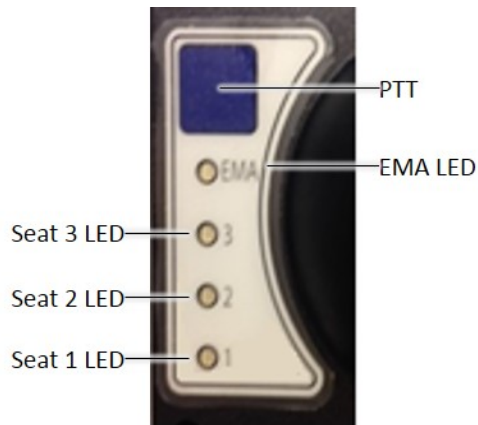
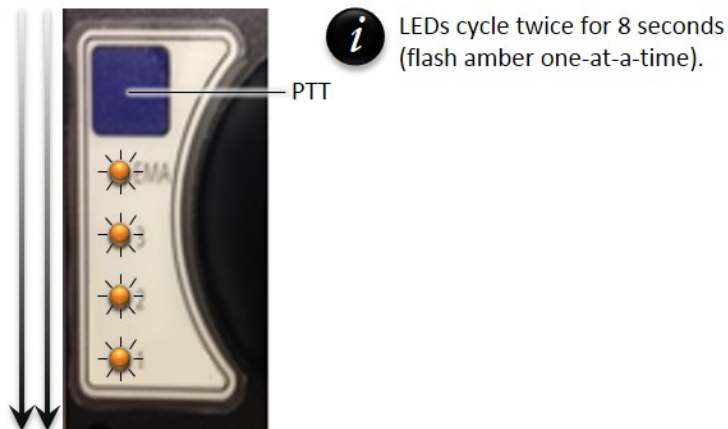

Figure 28. Cable Interface Assembly (55) Connection to the EMA (100)



EMA for up to Three Seats
and One Inflator Assembly
per Seat

Figure 29. EMA (100) LEDs



LEDs cycle twice for 8 seconds
(flash amber one-at-a-time).

EMA for up to Three Seats
and One Inflator Assembly
per Seat

Figure 30. LED Cycles

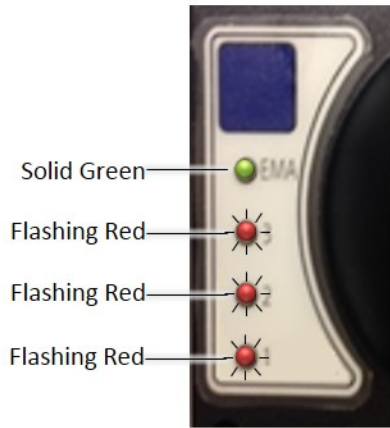

EMA



LEDs are lit for 6 seconds.

- EMA LED is solid green.
- Seat LEDs are flashing red. Flashing red LEDs are normal results.

After 6 seconds, the EMA LED remains solid green for wireless functions and all other LEDs are unlit.

If you did not have enough time to see the results, wait until LEDs are no longer lit (approximately 15 seconds) and retest.

EMA for up to Three Seats and One Inflator Assembly per Seat

Figure 31. Test Results



Figure 32. Connectors



Figure 33. Connectors - Locked Position



- (8) Peel the backing off of the airbag-equipped label (105 - 110) and affix the label (105 - 110) to the aircraft window.
- (9) Perform a functional test. (Refer to Testing and Fault Isolation).



1043 N. 47th Ave., Phoenix, AZ 85043 USA | www.amsafe.com
 602-850-2850

5. Testing and Fault Isolation

A. Description

(1) Testing and fault isolation verifies system readiness.

B. Personnel and Equipment

(1) Equipment or materials are not required.

C. Intervals

(1) Testing and fault isolation is performed:

- Upon completing the installation procedures.
- When a component has damage or malfunction has occurred.

SUBTASK 25-10-01-810-002

D. Procedure

(1) Perform testing and fault isolation on the connector half, buckle half and shoulder harness.

(a) Follow the steps in Table 3. If a test fails, follow the steps in Table 4 to determine the repair task. If the procedure in Table 4 did not resolve the failure, remove and return the inflatable restraint system assembly for further evaluation or overhaul by AmSafe.

NOTE: Refer to Removal and Installation to remove and replace damaged components.

Table 3. Test Procedure and Limits

Step	Procedure	Limits
1.	Insert the connector into the buckle.	The connector engages.
2.	Release the connector by lifting the metal latch on the buckle.	The connector releases and the metal latch on the buckle returns to its original position.
3.	Repeat steps 1 and 2 four times.	
4.	Adjust the webbing on the connector half by pulling on the free end of the webbing near the adjuster assembly.	The webbing adjusts and doesn't exhibit excessive fray or any cuts.
5.	Repeat step 4 four times.	
6.	Slowly pull the webbing on the shoulder harness all the way out of the inertia reel. (Do not let the webbing slap into place unrestrained.) Observe the webbing for freedom of movement and general appearance.	The webbing extends and does not exhibit excessive fray or any cuts.
7.	Slowly retract the webbing into the inertia reel.	The webbing retracts smoothly.
8.	Repeat steps 6 and 7 four times.	
9.	Withdraw approximately 25% of the webbing from the inertia reel and rapidly accelerate the webbing until the inertia reel locks.	The inertia reel should lock and the webbing should not extend.
10.	Slowly retract the webbing into the inertia reel.	The webbing retracts smoothly.
11.	Repeat steps 9 and 10 four times.	
12.	Slide the connector on the shoulder harness over the rivet on the connector.	The connector should present a small resistance and stay in place. The connector and rivet must not show signs of weakness.

Table 3. Test Procedure and Limits

Step	Procedure	Limits
13.	Remove the connector on the shoulder harness from the rivet on the connector.	The connector should present a small resistance and come off the rivet. The connector and rivet must not show signs of weakness.
14.	Repeat steps 12 and 13 four times.	

Table 4. Fault Isolation Procedure

Step in Table 3 Where Test Failed	Probable Cause of Failure	Repair Task
1 - 3	Damaged buckle half or connector half.	Remove and replace the buckle half or the connector half.
4 - 5	Damaged buckle half or connector half.	Remove and replace the buckle half or the connector half.
6 - 11	Damaged inertia reel.	Remove and replace the shoulder harness.
12 - 14	Damaged connector or rivet.	Remove and replace the shoulder harness or the connector half.

(2) Perform testing and fault isolation on the EMA.

(a) Read the warnings in Description and Operation.

NOTE: If necessary, remove and replace components following the procedures in Removal and Installation.

NOTE: If necessary, return components following the procedure in Storage.

(b) Ensure all electrical connections on the following components are secure.

- EMA
- Cable interface assembly and LRU/inflator cable interface
- Inflator assembly

WARNING: ENSURE THE EMA IS SECURED TO PREVENT UNINTENTIONAL DEPLOYMENT OF THE AIRBAG. UNINTENTIONAL DEPLOYMENT OF THE AIRBAG MAY INJURE PEOPLE OR DAMAGE EQUIPMENT.

(c) Ensure the EMA is secured.

WARNING: THE SYSTEM IS ALWAYS LIVE AS SOON AS ALL ELECTRICAL CONNECTIONS ARE MADE. TO MINIMIZE THE RISK OF INJURY TO PEOPLE OR DAMAGE TO EQUIPMENT, KEEP THE SYSTEM BUCKLED WHEN THE SEAT IS NOT IN USE.

(d) Ensure the inflatable restraint system assembly is buckled.

(e) Find the LEDs on the EMA (Figure 34).

NOTE: There is one LED for the EMA and three LEDs for up to three seat positions (one LED per seat position).

(f) Push the PTT button (Figure 35).

(g) Get diagnostic test results (Figure 36).

NOTE: Results are displayed for only 6 seconds before the EMA automatically performs a pairing routine (step 3). If you did not see the results, wait until the LEDs are no

longer lit and retest.

- 1 The test passed if passing results were obtained. The EMA automatically performs step 3.

NOTE: The passing result for seat position 3 is flashing red because there is no signal to the EMA.

- 2 The test failed if passing results were not obtained. The EMA automatically performs step 3. Go to step (h) and perform fault diagnosis.
- 3 The EMA automatically runs a pairing routine for wireless diagnostics (Figure 37).
 - a If passing results were obtained, testing is complete.
 - b The EMA failed if passing results were not obtained. Do not use the EMA. Remove and replace the EMA (refer to Removal and Installation) and return the EMA to AmSafe (refer to Storage).

(h) Perform fault isolation.

NOTE: For fault isolation, retest following steps (2)(c) - (2)(g).

NOTE: Refer to Removal and Installation to remove and replace components.

NOTE: If the problem is resolved during fault isolation, connect each P2 and P3 connector on the cable interface assembly (Figure 38) by seating the connectors and sliding the red tab forward until it engages. The red tab will not engage unless connectors are fully seated.

- 1 EMA LED - no illumination or red LED.
 - a Remove and replace the EMA (refer to Removal and Installation). Retest following steps (2)(c) - (2)(g). If the problem persists after replacing and retesting the EMA contact AmSafe Customer Service. If the problem is resolved, fault isolation is finished.
- 2 Seats 3 LED or 2 LED or 1 LED - no illumination.
 - a Reseat the connections on the cable interface assembly and retest following steps (2)(c) - (2)(g).
 - b If the problem persists remove and replace the EMA (refer to Removal and Installation) and retest following steps (2)(c) - (2)(g).
 - c If the problem persists contact AmSafe Customer Service.
- 3 Seats 3 LED or 2 LED or 1 LED - flashing LED
 - a Reseat the connections on the cable interface assembly (refer to Removal and Installation) and retest following steps (2)(c) - (2)(g).
 - b If the problem persists, remove and replace the cable interface assembly (refer to Removal and Installation) and retest following steps (2)(c) - (2)(g).
 - c If problem persists, remove and replace the LRU/inflator cable interface (refer to Removal and Installation) and retest following steps (2)(c) - (2)(g).
 - d If the problem persists remove and replace the EMA (refer to Removal and Installation) and retest following steps (2)(c) - (2)(g).
 - e If the problem persists contact AmSafe Customer Service.

- 4 Seats 3 LED or 2 LED or 1 LED - red LED
 - a Reseat the connections on the cable interface assembly and retest following steps (2)(c) - (2)(g).
 - b If the problem persists remove and replace the cable interface assembly (refer to Removal and Installation) and retest following steps (2)(c) - (2)(g).
 - c If problem persists, remove and replace the LRU/inflator cable interface (refer to refer to Removal and Installation) and retest following steps (2)(c) - (2)(g).
 - d If the problem persists remove and replace the EMA (refer to Removal and Installation) and retest following steps (2)(c) - (2)(g).
 - e If the problem persists remove and replace the inflator assembly (refer to Removal and Installation) and retest following steps (2)(c) - (2)(g).
 - f If the problem persists contact AmSafe Customer Service.
- 5 Seats 3 LED or 2 LED or 1 LED - amber LED
 - a Reseat the connections on the cable interface assembly and retest following steps (2)(c) - (2)(g).
 - b If the problem persists remove and replace the cable interface assembly (refer to Removal and Installation) and retest following steps (2)(c) - (2)(g).
 - c If problem persists, remove and replace the LRU/inflator cable interface (refer to refer to Removal and Installation) and retest following steps (2)(c) - (2)(g).
 - d If the problem persists remove and replace the EMA (refer to Removal and Installation) and retest following steps (2)(c) - (2)(g).
 - e If the problem persists remove and replace the inflator assembly (refer to Removal and Installation) and retest following steps (2)(c) - (2)(g).
 - f If the problem persists contact AmSafe Customer Service.

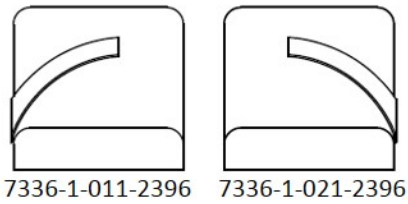
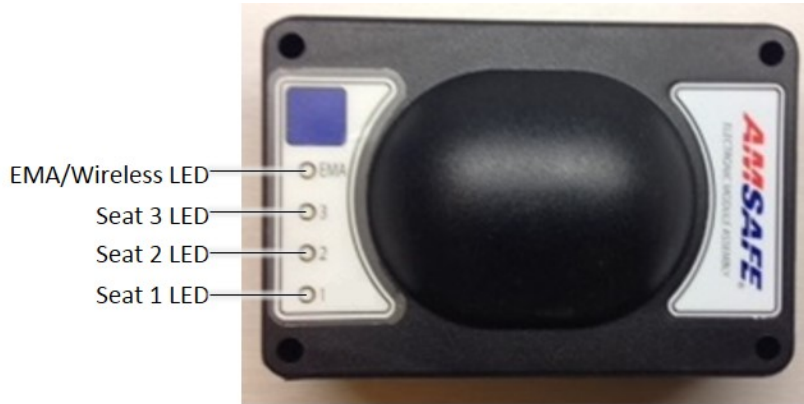

Figure 34. EMA and Aircraft LOPA

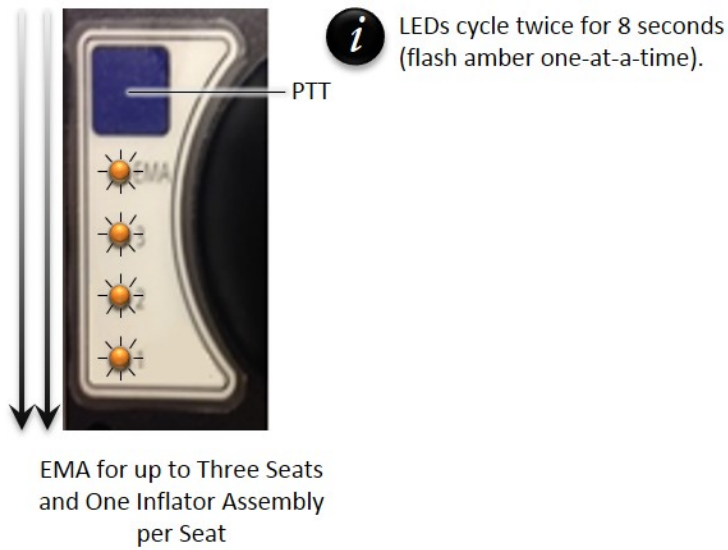
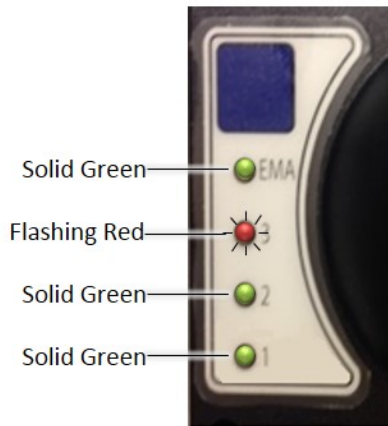

Figure 35. PTT Button



✓ Double Seats

i LEDs are lit for 6 seconds.

Flashing red LEDs for the seat positions are normal results.

If you did not have enough time to see the results, wait until seat LEDs are no longer lit (approximately 15 seconds) and retest.

Figure 36. Diagnostic Results

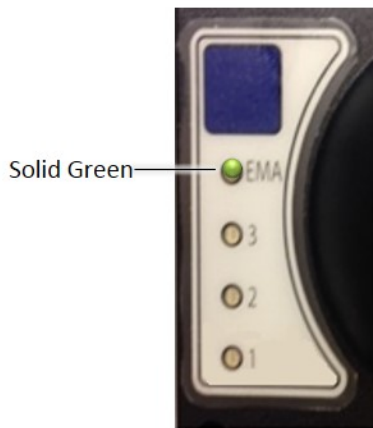

i Pairing routine for wireless diagnostics lasts approximately 15 seconds. After 15 seconds all LEDs turn off.

Figure 37. Pairing Routing



Red Tab
(Locked)

Figure 38. Locked Connectors

6. Removal

A. Description

- (1) Removal procedures provide instructions to safely remove the system and its components.
- (2) Contact for after-hours aircraft on ground (AOG): 602-432-6064.

B. Equipment and Materials

- (1) Use the following equipment and materials as required.
 - Standard aviation tools
 - Safety glasses

NOTE: Equivalent alternatives are permitted.

C. Removal

WARNING: THE SYSTEM (1) IS ALWAYS LIVE AS SOON AS ALL ELECTRICAL CONNECTIONS ARE MADE. TO MINIMIZE THE RISK OF INJURY TO PEOPLE OR DAMAGE TO EQUIPMENT, KEEP THE SYSTEM (1) BUCKLED WHEN THE SEAT IS NOT IN USE.

WARNING: ALWAYS DISCONNECT THE P2 AND P3 CONNECTORS ON THE CABLE INTERFACE ASSEMBLY (55) FOR EACH SEAT POSITION PRIOR TO ANY COMPONENT REPLACEMENT OR ELECTRICAL OR MECHANICAL SEAT MAINTENANCE.

- (1) Removal consists of the following steps.
 - (a) Read all removal procedures before proceeding. Refer to step 2.
 - (b) Ensure the system (1) (Figure 39) is buckled. Refer to step 3.
 - (c) Verify the system's (1) condition and note part numbers. Refer to step 4.
 - (d) Review installation. Refer to step 5.
 - (e) Isolate the power source [EMA (100)] from the inflator assembly (95). Refer to step 6.
 - (f) Remove the shoulder harness (45 - 50), connector half (15 - 20), and buckle half (35 - 40). Refer to step 7.
 - (g) Remove the EMA (100). Refer to step 8.
 - (h) Remove the cable interface assembly (55) and LRU/inflator cable interface (60). Refer to step 9.

- (2) Read all removal procedures before proceeding.

WARNING: THE SYSTEM (1) IS ALWAYS LIVE AS SOON AS ALL ELECTRICAL CONNECTIONS ARE MADE. TO MINIMIZE THE RISK OF INJURY TO PEOPLE OR DAMAGE TO EQUIPMENT, KEEP THE SYSTEM (1) BUCKLED WHEN THE SEAT IS NOT IN USE.

WARNING: ALWAYS DISCONNECT THE P2 AND P3 CONNECTORS ON THE CABLE INTERFACE ASSEMBLY (55) FOR EACH SEAT POSITION PRIOR TO ANY COMPONENT REPLACEMENT OR ELECTRICAL OR MECHANICAL SEAT MAINTENANCE.

- (3) Ensure the system (1) (Figure 39) is buckled.

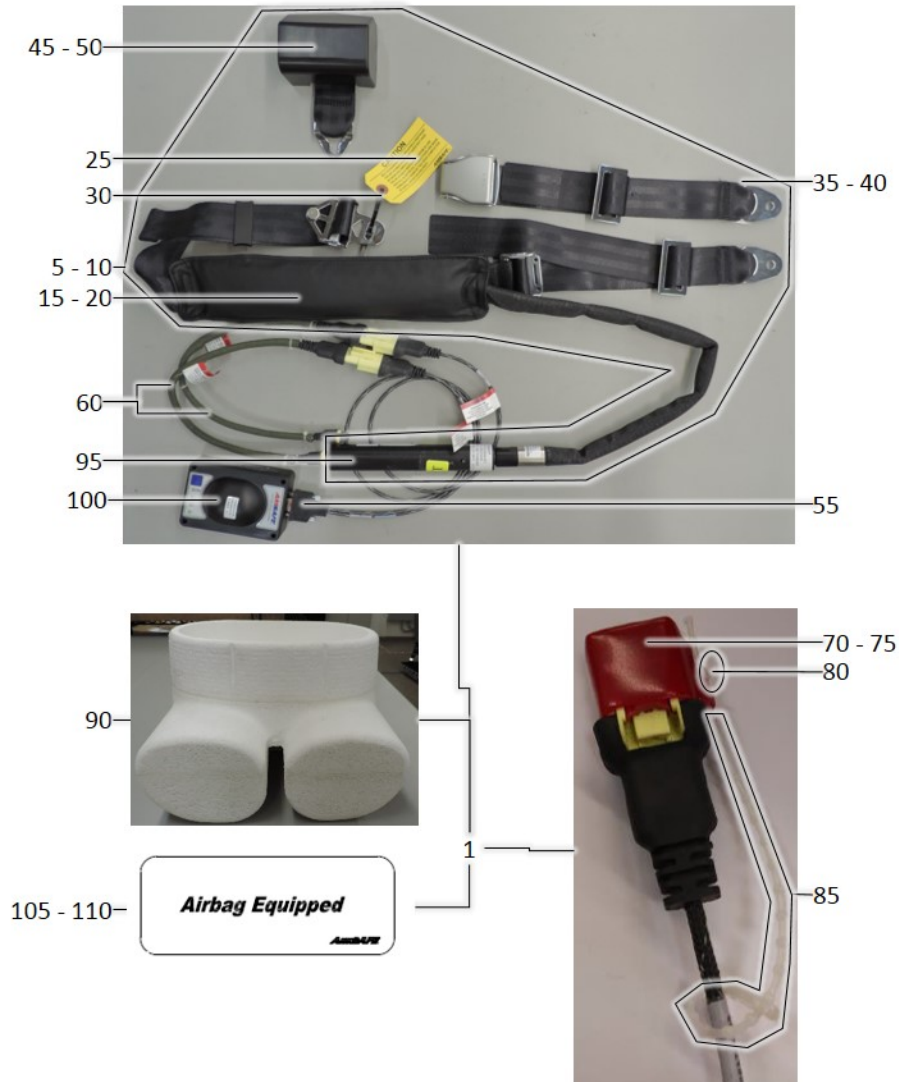

Figure 39. Components

(4) Verify the system's (1) condition and note part numbers.

(a) Examine the system (1) for anomalies.

- 1 EMA (100): look for evidence of dropping or mishandling (e.g., dents, nicks and cuts).
- 2 Inflator assembly (95): look for loose hardware or connections (e.g., a loose squib connector subassembly) or an improperly routed or secured fabric hose subassembly.
- 3 Fabric hose subassembly: look for holes, fraying, tears, pinching or twists of more than 180 degrees.

- 4 Cable interface assembly (55) and LRU/inflator cable interface (60): look for fraying, tears, pinching, missing cable ties, exposed or sharp seat edges, tight connections and damaged connectors.
 - 5 Seatbelt hardware (i.e., end fittings, buckle and connector): look for cracks, dents or corrosion.
- (5) Review installation.
 - (a) Inflator assembly (95): note position and orientation, existing hardware and mounting.
 - (b) Fabric hose subassembly: note the connections i.e., to the inflator assembly (95).
 - (c) Cable interface assembly (55) and LRU/inflator cable interface (60): note location and method of securing, cable hardware [e.g., x-tree clip (65)] and cable connections such as connections to the EMA (100).
 - (d) EMA (100): note position (aircraft forward), existing hardware and mounting.
- (6) Isolate the power source [EMA (100)] from the inflator assembly (95).

NOTE: The EMA (100) is the power source.

- (a) Locate the P2 and P3 connectors on the cable interface assembly (55) (Figure 40). Disconnect the connectors by sliding the red tab backwards to the unlocked position, depressing the yellow tab and pulling the connectors apart (Figure 41).

NOTE: If the connectors are difficult to access, perform step b and then perform step a.

- 1 Secure the dust cap (70) over the connector on the cable interface assembly (55).
 - 2 Secure the dust cap (75) over the connector on the LRU/inflator cable interface (60).

- (b) Disconnect the squib connector subassembly from the inflator assembly (95) by squeezing both sides of the squib connector subassembly and gently pulling away from the inflator assembly (95) (Figure 42).

WARNING: THE INFLATOR ASSEMBLY (95) CONTAINS COMPRESSED GAS. DEATH OR INJURY TO PEOPLE OR DAMAGE TO EQUIPMENT MAY RESULT FROM MISUSE, MISHANDLING OR TAMPERING.

WARNING: THE INFLATOR ASSEMBLY (95) CONTAINS A NEUTRAL THRUST PORT.

WARNING: DO NOT CLAMP OVER, BIND AGAINST, OR TORQUE AGAINST THE WELD BALL ON THE INFLATOR ASSEMBLY (95). DAMAGE TO THE WELD BALL IS A POTENTIAL SAFETY HAZARD.

CAUTION: Use only soft-jaw pliers or a strap wrench. Do not damage the end of the fabric hose subassembly or the inflator assembly (95).

- (c) Separate the inflator assembly (95) from the fabric hose subassembly (Figure 43 and Figure 44) using soft-jaw pliers or a strap wrench to loosen and rotate the inflator assembly (95) from the fabric hose subassembly. Remove the existing hardware and retain for replacement.
- (d) Cap or plug the opening on the fabric hose subassembly to prevent debris entry.

- WARNING:** THE INFLATOR ASSEMBLY (95) CONTAINS COMPRESSED GAS. DEATH OR INJURY TO PEOPLE OR DAMAGE TO EQUIPMENT MAY RESULT FROM MISUSE, MISHANDLING OR TAMPERING.
- WARNING:** DO NOT MISHANDLE OR TAMPER WITH THE INFLATOR ASSEMBLY (95) IN ANY WAY. THE INFLATOR ASSEMBLY (95) SHALL BE HANDLED AND STORED BY PEOPLE TRAINED IN THE REQUIREMENTS ASSOCIATED WITH DANGEROUS GOODS.
- WARNING:** DO NOT GRASP OR CARRY THE INFLATOR ASSEMBLY (95) BY ITS DIFFUSER.
- WARNING:** NEVER ATTEMPT TO OPEN THE INFLATOR ASSEMBLY (95) FOR SERVICING.
- WARNING:** NEVER PROBE OR APPLY ELECTRICAL CURRENT TO THE INFLATOR ASSEMBLY'S (95) ELECTRICAL CONNECTIONS.
- WARNING:** DO NOT CLAMP OVER, BIND AGAINST, OR TORQUE AGAINST THE WELD BALL ON THE INFLATOR ASSEMBLY (95). DAMAGE TO THE WELD BALL IS A POTENTIAL SAFETY HAZARD.
- (e) Remove the inflator assembly (95) by removing its existing hardware and removing the inflator assembly (95). Do not handle the inflator assembly (95) by its diffuser (Figure 45).
- (f) Store the inflator assembly (95). [Refer to Storage.]



Figure 40. Connectors



Figure 41. Connectors - Unlocked Position

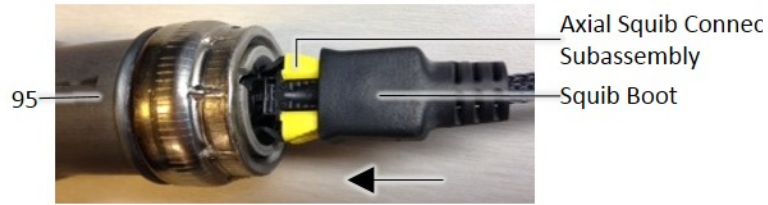

Figure 42. Squib Connector Subassembly Connection to Inflator Assembly (95)



Figure 43. Weld Ball

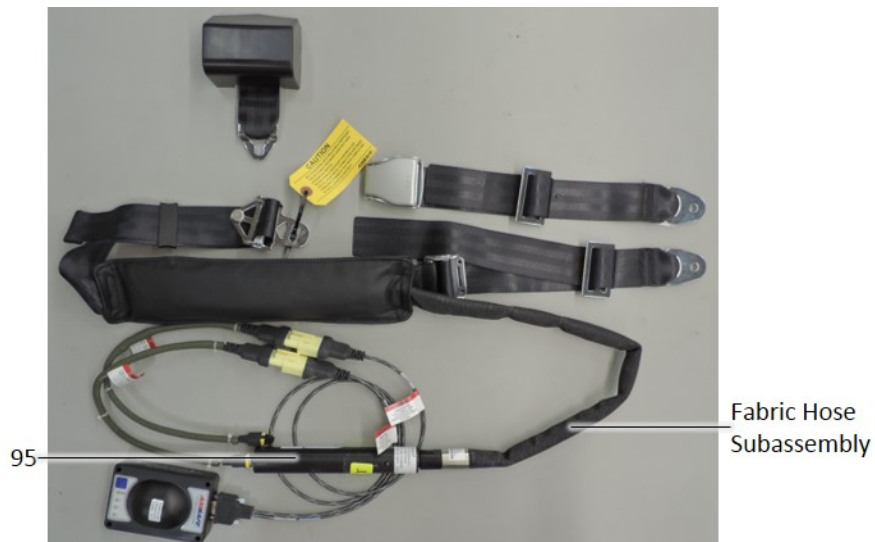

Figure 44. Fabric Hose Subassembly Connection to Inflator Assembly (95)

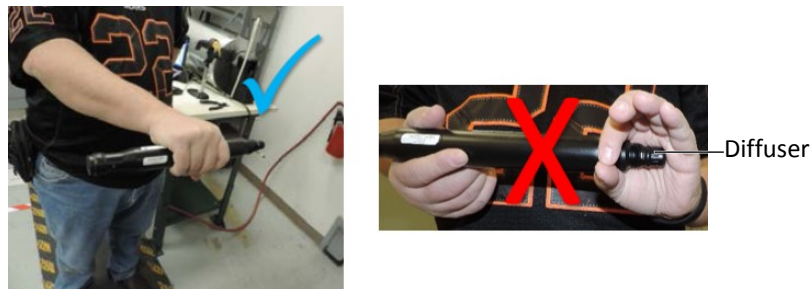

Figure 45. Inflator Assembly Handling

- (7) Remove the shoulder harness (45 - 50), connector half (15 - 20), and buckle half (35 - 40).
- (a) Disconnect the connector on the shoulder harness (45 - 50) from rivet on the connector.
- NOTE:** If the inflatable restraint system assembly (5 - 10) is installed as a two-point restraint skip step a and step b.
- (b) Disconnect the inertia reel from the mounting point.
- NOTE:** Retain hardware for installation.
- 1 Remove the cover on the inertia reel.
- 2 Remove the inertia reel.
- (c) Disconnect the connector half (15 - 20) and the buckle half (35 - 40) from the seatbelt mounting points by detaching the end fitting (Figure 46).
- NOTE:** Retain hardware for installation.
- (d) Store the shoulder harness (45 - 50), inertia reel cover, connector half (15 - 20), and buckle half (35 - 40). [Refer to STORAGE.]



Figure 46. End Fitting on Connector Half (15 - 20)

- (8) Remove the EMA (100).
- WARNING:** DO NOT DROP OR MISHANDLE THE EMA (100). DAMAGE TO THE ELECTRONICS, BATTERY OR SENSOR MAY OCCUR. IF THE EMA (100) IS DROPPED OR DAMAGED THERE IS THE POTENTIAL FOR AN ANOMALY, SUCH AS NOT FUNCTIONING AS INTENDED OR DESIGNED. A DAMAGED OR MISHANDLED EMA (100) COULD INJURE PEOPLE OR DAMAGE EQUIPMENT IF INSTALLED ON THE SEAT. IF DAMAGE OR MISHANDLING HAS OCCURRED OR IS SUSPECTED, DO NOT INSTALL THE EMA (100). RETURN THE EMA (100) TO AMSAFE FOR REPLACEMENT.
- (a) Unscrew the thumb screws on the cable interface assembly (55) and pull the cable interface assembly (55) straight out (Figure 47).
- (b) Remove the four fasteners on the EMA (100) and remove the EMA (100).
- (c) Remove the EMA bracket.)
- (d) Store the EMA (100) and the EMA bracket. (Refer to Storage.)

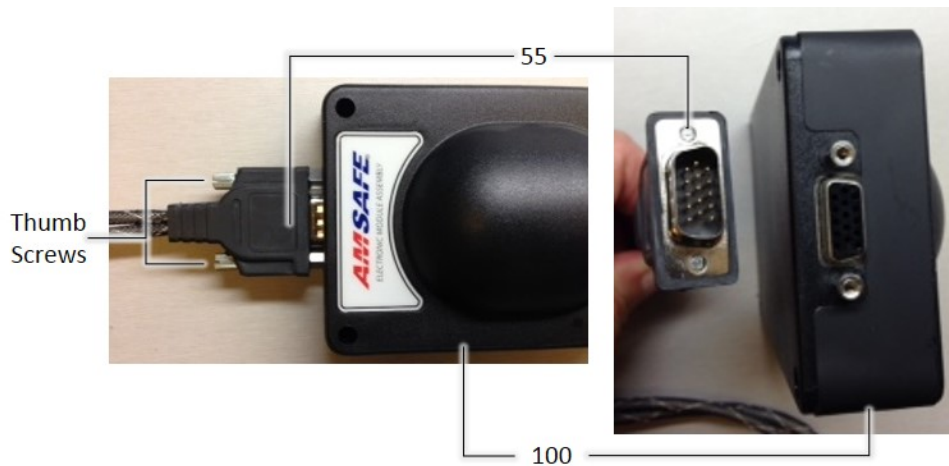

Figure 47. Cable Interface Assembly (55) Connection to the EMA (100)

- (9) Remove the cable interface assembly (55) and LRU/inflator cable interface (60).
 - (a) Remove the hardware securing the cable interface assembly (55) and remove the cable interface assembly (55).
 - (b) Remove the hardware securing the LRU/inflator cable interface (60) and remove the LRU/inflator cable interface (60).
 - 1 Remove the x-tree clip (65) on the LRU/inflator cable interface (60) by holding onto the connector, attaching needle-nose pliers to the end of the x-tree clip (65) and pulling outwards (Figure 48).
- NOTE:** Do not damage the end of the connector.
- (c) Store the cable interface assembly (55) and LRU/inflator cable interface (60). [Refer to STORAGE.]



Figure 48. X-Tree Clip (65) Removal



7. Storage

A. Description

- (1) The information and procedures in storage ensures the system and its components are appropriately handled, shipped, stored and disposed.

NOTE: With the exception of warnings, cautions and notes, these instructions are general.

B. Personnel

- (1) Personnel should review these installation instructions and be trained in handling dangerous goods.

C. Equipment and Materials

- (1) Use the following equipment and materials as required.

- Packaging material (e.g., bubble wrap or wrapping paper)
- U.S. DOT-approved container that is UN (United Nations) tested and marked under UN performance oriented packing (POP).

NOTE: Equivalent alternatives are permitted.

D. Safety Warnings, Cautions and Notes

- (1) Read all warnings and cautions prior to working on any system.

WARNING: THE SYSTEM IS ALWAYS LIVE AS SOON AS ALL ELECTRICAL CONNECTIONS ARE MADE. TO MINIMIZE THE RISK OF INJURY TO PEOPLE OR DAMAGE TO EQUIPMENT, KEEP THE SYSTEM BUCKLED WHEN THE SEAT IS NOT IN USE.

WARNING: IN THE CASE OF A SYSTEM DEPLOYMENT, DO NOT USE ANY SEAT WITH A SYSTEM SHARING THE SAME EMA AS THE DEPLOYED SYSTEM. REMOVE AND RETURN ALL COMPONENTS TO AMSAFE.

- (a) Follow the above warnings for seats and refer to Figure 49 to locate the connectors on the cable interface assembly.

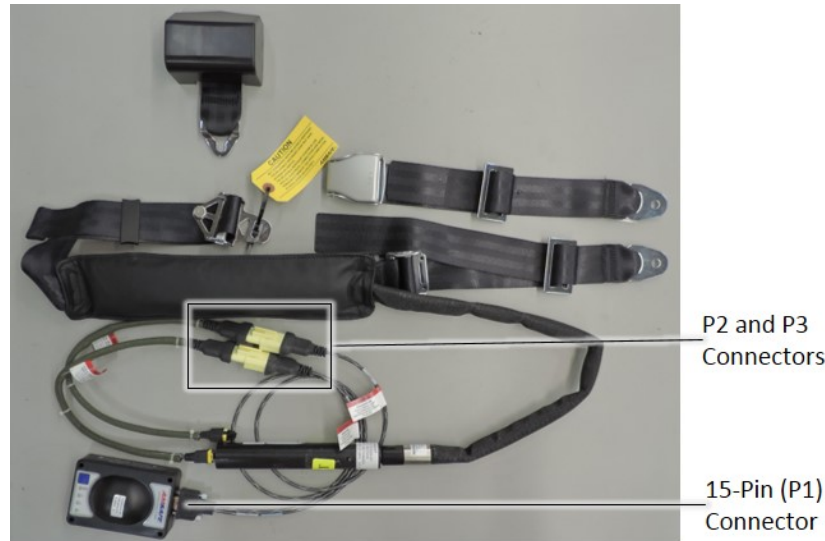

Figure 49. 15-Pin and P2 and P3 Connectors on Cable Interface Assembly

(2) Connector Half and Buckle Half

WARNING: THE SYSTEM IS ALWAYS LIVE AS SOON AS ALL ELECTRICAL CONNECTIONS ARE MADE. TO MINIMIZE THE RISK OF INJURY TO PEOPLE OR DAMAGE TO EQUIPMENT, KEEP THE SYSTEM BUCKLED WHEN THE SEAT IS NOT IN USE.

WARNING: ALWAYS DISCONNECT THE P2 AND P3 CONNECTORS ON THE CABLE INTERFACE ASSEMBLY FOR EACH SEAT POSITION PRIOR TO ANY COMPONENT REPLACEMENT OR ELECTRICAL OR MECHANICAL SEAT MAINTENANCE.

(a) Follow the above warnings for the connector half and buckle half.

(3) EMA

WARNING: DO NOT DROP OR MISHANDLE THE EMA. DAMAGE TO THE ELECTRONICS, BATTERY OR SENSOR MAY OCCUR. IF THE EMA IS DROPPED OR DAMAGED THERE IS POTENTIAL FOR AN ANOMALY, SUCH AS NOT FUNCTIONING AS INTENDED OR DESIGNED. A DAMAGED OR MISHANDLED EMA COULD INJURE PEOPLE OR DAMAGE EQUIPMENT IF INSTALLED ON THE SEAT. IF DAMAGE OR MISHANDLING OCCURRED OR IS SUSPECTED, DO NOT INSTALL THE EMA. RETURN THE EMA TO AMSAFE FOR REPLACEMENT.

(a) Follow the above warning for the EMA.

(4) Inflator Assembly

- WARNING:** THE INFLATOR ASSEMBLY CONTAINS COMPRESSED GAS. DEATH OR INJURY TO PEOPLE MAY OCCUR THROUGH MISUSE, MISHANDLING OR TAMPERING.
- WARNING:** DO NOT MISHANDLE OR TAMPER WITH THE INFLATOR ASSEMBLY IN ANY WAY. THE INFLATOR ASSEMBLY SHALL BE HANDLED AND STORED BY PEOPLE TRAINED IN THE REQUIREMENTS ASSOCIATED WITH DANGEROUS GOODS.
- WARNING:** NEVER ATTEMPT TO OPEN THE INFLATOR ASSEMBLY FOR SERVICING.
- WARNING:** NEVER PROBE OR APPLY ELECTRICAL CURRENT TO THE INFLATOR ASSEMBLY'S ELECTRICAL CONNECTIONS.
- WARNING:** KEEP THE INFLATOR ASSEMBLY AWAY FROM SOURCES OF THERMAL IGNITION, ELECTRIC SPARKS OR FLAME, IMPACT OR MECHANICAL IGNITION OR ELECTRO-STATIC DISCHARGE. AUTOIGNITION MAY OCCUR WHEN THESE SOURCES ARE PRESENT AND MAY RESULT IN DEATH OR INJURY TO PEOPLE OR DAMAGE TO EQUIPMENT.

- (a) Follow the above warnings for the inflator assembly.

E. Procedure

CAUTION: Do not use packing material (e.g., packing peanuts) that allows the system or its components to shift. This packing material does not prevent damage to the system or its components.

NOTE: Observe local, national and international regulations. Failure to comply with regulations for dangerous goods may result in civil or criminal penalties.

NOTE: Contact AmSafe Customer Service for any shipping questions or concerns.

NOTE: Contact AmSafe Customer Service to obtain a return material authorization (RMA) number and shipping address. Provide the customer's name, location, contact person and phone number.

NOTE: Contact AmSafe Customer Service to receive packaging materials and work instructions to properly pack and assemble materials.

(1) General Shipping Procedure

(a) Use the original packaging if it is available and in a usable condition or use new packaging of the same quality and size.

(b) Use a minimum of three inches of packaging material to prevent the system or component from shifting during shipping.

1 Use packaging material (e.g., bubble wrap) to protect parts.

2 Line the sides, top and bottom of shipping containers with packaging material (e.g., wrapping paper) to prevent movement. If necessary, use partitions or dividers for added protection.

NOTE: Use packaging material (e.g., bubble wrap) to protect plated parts.

3 Ensure the label is legible, durable and located and secured such that it will not be obstructed or lost when the package is shipped. Ensure the label contains the following items.

- Customer address
- AmSafe's shipping address

- RMA number
- Hazardous material labels per 49 CFR §172.400 and 49 CFR §172.301
- Labels required by country of shipping origin

(2) Inflatable Restraint System Assembly

WARNING: THE SYSTEM IS ALWAYS LIVE AS SOON AS ALL ELECTRICAL CONNECTIONS ARE MADE. TO MINIMIZE THE RISK OF INJURY TO PEOPLE OR DAMAGE TO EQUIPMENT, KEEP THE SYSTEM BUCKLED WHEN THE SEAT IS NOT IN USE.

WARNING: ALWAYS DISCONNECT THE P2 AND P3 CONNECTORS ON THE CABLE INTERFACE ASSEMBLY FOR EACH SEAT POSITION PRIOR TO ANY COMPONENT REPLACEMENT OR ELECTRICAL OR MECHANICAL SEAT MAINTENANCE.

(a) Shipping

- 1 Return the inflatable restraint system assembly following the General Shipping Procedure.

NOTE: An inflatable restraint system assembly with a functional defect must be returned to AmSafe.

NOTE: To claim warranty, an inflatable restraint system assembly that is under warranty and have a manufacturing defect must be returned to AmSafe using an RMA.

(3) Cable Interface Assembly and LRU/Inflator Cable Interface

(a) Shipping

- 1 Return the cable interface assembly and LRU/inflator interface cable following the General Shipping Procedure.

NOTE: A cable interface assembly or LRU/inflator interface cable with a functional defect must be returned to AmSafe.

(4) EMA

(a) Shipping

- 1 Return the EMA following the General Shipping Procedure.

NOTE: An EMA with a functional defect must be returned to AmSafe.

NOTE: To claim warranty, an EMA that is under warranty and has a manufacturing defect must be returned to AmSafe using an RMA.

NOTE: AmSafe cannot warranty the EMA or be found liable for any unauthorized use or installation of the EMA.

NOTE: The EMA contains a lithium-ion disulfide, non-rechargeable battery. The EMA must be shipped to UN3091 in compliance with PI 970, section II - Lithium Batteries Contained in Equipment.

NOTE: The EMA should be shipped following all international, national and local regulations. Failure to comply with regulations for dangerous goods may result in civil or criminal penalties.

NOTE: For regulated materials, compliance with the applicable transportation requirements is strictly the responsibility of the user and not AmSafe.

(b) Handling

WARNING: DO NOT DROP OR MISHANDLE THE EMA. DAMAGE TO THE ELECTRONICS, BATTERY OR SENSOR MAY OCCUR. IF THE EMA IS DROPPED OR DAMAGED THERE IS POTENTIAL FOR AN ANOMALY, SUCH AS NOT FUNCTIONING AS INTENDED OR DESIGNED. A DAMAGED OR MISHANDLED EMA COULD INJURE PEOPLE OR DAMAGE EQUIPMENT IF INSTALLED ON THE SEAT. IF DAMAGE OR MISHANDLING OCCURRED OR IS SUSPECTED, DO NOT INSTALL THE EMA. RETURN THE EMA TO AMSAFE FOR REPLACEMENT.

- 1** Follow the above warning when handling the EMA.

NOTE: The EMA should be handled by personnel trained in handling dangerous goods.

(5) Inflator Assembly

(a) Shipping

- 1** Return the inflator assembly following the general shipping procedure.

NOTE: Follow all international, national and local regulations. Failure to comply with regulations for dangerous goods may result in civil or criminal penalties.

NOTE: The inflator assembly is classified by the U.S. DOT as Class 9, air bag inflators, UN3268.

NOTE: Refer to DOT special provision (DOT-SP) DOT SP 12122. Once the inflator assembly is installed it is no longer regulated by the DOT.

NOTE: Refer to emergency response guide (ERG) 171.

NOTE: Failure to comply with all relevant dangerous goods regulations regarding the system may result in civil or criminal penalties.

NOTE: Components with a functional defect must be returned to AmSafe.

NOTE: To claim warranty, an inflator assembly that is under warranty and has a manufacturing defect must be returned to AmSafe using an RMA.

NOTE: The inflator assembly must be shipped in either packaging provided by AmSafe or a U.S. DOT-approved container that is UN tested and marked under UN POP.

NOTE: Contact AmSafe Customer Service to receive packaging materials and work instructions to properly pack and assemble materials.

- 2** Use the original packaging if it is available and in a usable condition or use new packaging of the same quality and size that conforms to UN POP.

- 3** Use a minimum of three inches of cushioning material to prevent the component from shifting in the packaging.

- 4** Ensure the label is legible, durable, and located and secured such that it will not be obstructed or lost when the package is shipped, closed or opened. Ensure the label contains the following items.

- Customer address
- AmSafe's shipping address
- RMA number

- Hazmat labels per 49 CFR §172.400 and 49 CFR §172.301
- Labels required by country of shipping origin

(b) Handling

WARNING: THE INFLATOR ASSEMBLY CONTAINS COMPRESSED GAS. DEATH OR INJURY TO PEOPLE MAY OCCUR THROUGH MISUSE, MISHANDLING OR TAMPERING.

WARNING: DO NOT GRASP OR CARRY THE INFLATOR ASSEMBLY (95) BY ITS DIFFUSER.

WARNING: IF DAMAGE OR MISHANDLING OF THE SYSTEM OR ITS COMPONENTS OCCURRED OR IS SUSPECTED, RETURN THE SYSTEM OR COMPONENT TO AMSAFE.

WARNING: NEVER ATTEMPT TO OPEN THE INFLATOR ASSEMBLY FOR SERVICING.

WARNING: NEVER PROBE OR APPLY ELECTRICAL CURRENT TO THE INFLATOR ASSEMBLY'S ELECTRICAL CONNECTIONS.

- 1** Follow the above warnings when handling the inflator assembly. Do not handle the inflator assembly (95) by its diffuser (Figure 50.)

NOTE: The inflator assembly shall be handled by personnel trained in handling dangerous goods in accordance with 49 CFR §172.700.

NOTE: Refer to ATTACHMENT A for the safety data sheet (SDS).



Figure 50. Inflator Assembly Handling

(6) Transporting Seats Equipped with the System

WARNING: DISABLE THE SYSTEM BEFORE MOVING, SHIPPING OR INSTALLING A SEAT. THE SYSTEM MAY DEPLOY AND MAY CAUSE DEATH OR INJURY TO PEOPLE OR DAMAGE TO EQUIPMENT IF THE SEAT RECEIVES AN IMPACT (E.G., DROPPING OR HAMMERING THE SEAT). THE SYSTEM MUST BE DISABLED BY DISCONNECTING THE P2 AND P3 CONNECTORS ON THE CABLE INTERFACE ASSEMBLY.

WARNING: DO NOT DROP OR MISHANDLE A SEAT. IF DROPPING OR MISHANDLING OCCURS, PERFORM AN INSPECTION/CHECK TO ENSURE THE SYSTEM IS PROPERLY SECURED AND COMPONENTS ARE NOT DAMAGED. IF ANY DAMAGE IS NOTED, REMOVE AND RETURN THE ENTIRE SYSTEM.

WARNING: IN THE CASE OF A SYSTEM DEPLOYMENT, DO NOT USE ANY SEAT WITH A SYSTEM SHARING THE SAME EMA AS THE DEPLOYED SYSTEM. REMOVE AND RETURN ALL COMPONENTS TO AMSAFE.

- (a)** Disable the system by disconnecting the P2 and P3 connectors on the cable interface assembly.



1043 N. 47th Ave., Phoenix, AZ 85043 USA | www.amsafe.com
602-850-2850

SOARS Customer Service: SOARS@amsafe.com
SOARS Technical Support: SOARS_Support@amsafe.com

- (b) Protect the buckle from damage by folding the buckle half on itself and securing it in protective packaging (e.g., bubble wrap).



1043 N. 47th Ave., Phoenix, AZ 85043 USA | www.amsafe.com
602-850-2850

SOARS Customer Service: SOARS@amsafe.com
SOARS Technical Support: SOARS_Support@amsafe.com

ATTACHMENT A - ARC AUTOMOTIVE SDS

ARC Automotive, Inc. **Material Safety Data Sheet**

1. Product and Contact Information

Product Name: Hybrid Airbag Inflator Assembly

Chemical Name / Synonym / Trade Name: Inflator Assembly
Pseudonyms/Programs: APH, AHS, SH5, CADH, PH7-120, PH7-90, PH5, PH5.1, CH3, CH5, Piston, HC38, HD38, ADH89, MHS, DH7, DH8, MPD,SP2, PH8, etc

Manufacturer's Name: ARC Automotive, Inc.
Address: 1601 Midpark Road Suite 100
Knoxville, TN 37921

ARC Information Phone Number: (865) 583-7851
Emergency Phone (Chemtrec) Inside USA (800) 424-9300

2. Hazards Identification

Appearance and Odor: The device is a Steel Cylinder containing pressurized gas and energetic material.

HMIS: Health: 0
Flammability: 0
Physical Hazard: 2

Personal Protection: Heat Protective Gloves, Eye Protection, Hearing Protection
May cause burns if deployed by hand

Relevant routes of exposure: Skin, Eye, Hearing
Inhalation: None. If device vents/functions, the products of combustion have been demonstrated to comply with ACGIH exposure limits.
Skin contact: May cause burns if deployed by hand
Eye contact: Protect eyes from debris
Hearing: Hearing protection from impact noise, exceeds 85 dBa

3. Composition / Information on Ingredients

Emergency Overview: The tamper-resistant, sealed metal container poses limited risk of chemical exposure before deployment. It **may** cause some skin and respirable irritation after deployment. If inflator is incinerated, broken, drilled into, crushed, or electric current is connected to lead wires, a physical hazard may exist. This inflator contains solid gas generant. *Do not* drill, break, or breach the steel container.

Potential Health Effects None expected when used as intended. Effluent gases from multiple deployments in testing situations may cause skin, eye, or mucous membrane irritation. Effluent gases in these situations must be effectively controlled through engineering systems designed and tested to remove applicable contaminants or PPE that will accomplish the same effect.
Inflator does not contain azide.

Human Health Effects and Symptoms of Overexposure

Inhalation	None expected when used as intended.
Skin Contact	None expected when used as intended.
Eyes	None expected when used as intended.
Ingestion	None expected when used as intended.
Carcinogenicity	None expected when used as intended.
Medical Conditions Aggravated by Exposure	None expected when used as intended.
Target Organs	None expected when used as intended.
Potential Environmental Effects	None expected when used as intended.

The inflator assembly is a steel pressure vessel containing igniter assemblies, compressed gas composed of between 0 and 170 grams of 75-98% argon / 2-50% helium mixture. It also contains the following potentially hazardous chemicals formulated into the gas generant components.

<u>HAZARDOUS INGREDIENTS</u>		<u>CAS NO.</u>	<u>Carcinogen</u>
ARCAIR 102A/ 102H/ 102K/ 102J:	up to 40g:	Not Listed	No
• Ammonium Nitrate		6484-52-2	No
• Guanidine Nitrate		506-93-4	No
• Potassium Nitrate		7757-79-1	No
• Potassium Perchlorate		7778-74-7	No
• Polyvinyl Alcohol		9002-89-5	No
• Copper Phthalocyanine		147-14-8	No
• Graphite		7782-42-5	No
ARCADENE 459 or ARCITE 497L:	up to 30.0g:	Not Listed	No
• Polyurethane Binder System		68951-41-7	No
• Potassium Perchlorate		7778-74-7	No
• Dioctyl Adipate		103-23-1	No
• Polyvinyl Chloride		9002-86-2	No
• Lithium Carbonate		554-13-2	No
FS01	up to 3.5 g:	Not Listed	No
• Proprietary Ingredients		None	No
AIC	up to 0.5 g:	Not Listed	No
• Molybdenum		7439-98-1	No
• Silver Nitrate		7761-88-8	No
• Potassium Nitrate		7758-09-0	No
• Guanidine Nitrate		506-93-4	No
• Cab-O-Sil		112945-52-5	No
Initiator:	up to 2 at 260mg ea.	Not Listed	No
• Zirconium Potassium Perchlorate		Not listed	No

4. First Aid Measures

Inhalation:	None
Skin Contact:	Treat for second degree burn, cool burn area
Eye contact:	Immediately flush eyes with plenty of water for at least 15 minutes. Get medical attention
Heating:	Avoid repeated exposure

5. Fire and Explosive Data

Special Fire and Explosive Hazards:	N/A
Extinguishing Media:	Copious amounts of water
Special Fire Fighting Procedures:	Apply water until the fire is extinguished and the device has cooled to a temperature less than 130°C The device will relieve pressure at relatively low temperatures and is designed to move no more than 2 to 3 meters when pressure is relieved. No special protective equipment required for firefighters.
Hazardous Combustion Products:	N/A
Conditions Which Cause Ignition:	When the device reaches a temperature in excess of 130 °C , it will release the stored gas. Additional heating will result in burning of the energetic materials. All energetic materials are consumed if the device reaches a temperature in excess of 300°C .

Date: 21 December 2015

If the igniter is stimulated with an electrical current in the excess of 1.2 amps, the device will function; result is rapid combustion of the energetic materials and release of the stored gas.

6. Accidental Release Measures

Environmental precautions:	None expected
Clean up & Containment Method:	When handled and installed properly, no spills or leaks should occur. If inflator is ruptured and gas generant is present, clean up with non-sparking tools. Avoid spark, static electricity, and open flame. Avoid raising dust. Ventilate area. Wash spill site with water after material pick-up is complete.
Unusual Fire & Explosion Hazards:	The device (inflator assembly) is a container with compressed gas at up to 7000 psig pressure supplemented by rapidly burning gas generant materials. If the device is exposed to high temperature, the pressure system will release argon/helium gas mixture. Continued heating will cause the propellant to ignite and combustion gases to be released. The combustion gases are non-toxic, and have demonstrated compliance with ACGIH exposure limits.

7. Handling and Storage

Handling:	Avoid spark, ESD, impact, friction and open flame. Do not puncture or crush or drop. Post deployment, the surface of the inflator may have trace amounts of particulate and is usually hot. Residue may be irritating to the skin, eyes and mucous membranes.
Storage:	When not in use, devices should be stored in original shipping containers. Store away from high temperatures, open flame, static electricity, and other ignition sources. Store in accordance with federal, state, and local regulations. Recommend storage at ambient temperatures.

8. Exposure Controls Personal Protection

Engineering Controls:	Do not expose to excessive heat or flame. Do not puncture or crush. Do not expose to electrical current. Do not incinerate.
Respiratory Protection:	None
Skin Protection:	Heat Protection Gloves
Eye/Face Protection:	Safety Glasses
Hearing Protection:	Hearing Protection, Ear Muffs

9. Physical and Chemical Properties

Boiling Point:	N/A	Vapor Density:	N/A
Melting Point:	N/A	Specific Gravity:	N/A
Vapor Pressure:	N/A	Evaporation Rate:	N/A
Solubility:	N/A.		
Appearance and Odor:	The device is a Steel Cylinder/Toroid containing pressurized gas and energetic material.		

10. Stability and Reactivity

Stability:	Sealed unit is stable when used as designed.
Conditions to Avoid:	Sparks, static electricity, open flame, and hot temperatures
Incompatible Materials:	None in present form.

11. Toxicological Information

Carcinogen Status:	None Known
Target Organ and Other Health Effects:	None Known

12. Ecological Information

When used properly, no environmental effects are anticipated.

Persistence and Degradability	Perchlorate Material – Special handling may apply. See www.dtsc.ca.gov/hazardouswaste/perchlorate
-------------------------------	--

13. Disposal Considerations

Information provided is for unused product only

Recommended method of disposal:	Dispose in accordance with Federal, State and local regulations
EPA hazardous waste number:	Not a RCRA Waste

14. Transportation Information

SPECIAL HANDLING, STORAGE, AND PACKAGING RECOMMENDATIONS: This MSDS is not intended to have all required shipping information. When not used, devices should be stored in original shipping containers. Do not drop or expose to temperatures above 107C.

Identification number	UN3268
Proper shipping name	Safety Device
Hazard Classification	Class 9
Special Permit	Product Dependent. Available upon request
For further information contact: ARC Automotive, Inc 1729 Midpark Rd. Knoxville, TN 37921	

15. Regulatory Information

United States Regulatory Information

TSCA 8 (b) Inventory Status:	Contains none listed
TSCA 12 (b) Export Notification:	None
CERCLAS/Sara	None Listed
California Proposition 65:	Could affect California's Perchlorate Contamination Prevention Act 2003 (AB 826)

16. Other Information

For Technical Information: Vice President of Engineering ARC Automotive Inc. Knoxville, TN 37921 (865) 583-7600	For Health and Safety Information: Health, Safety, & Environmental Manager ARC Automotive Inc. Knoxville, TN 37921 (865) 583-7851
--	--

DISCLAIMER: The information presented herein is based on data considered to be accurate as of the date of preparation of this Material Safety Data Sheet. However, no warranty or representation, express or implied, is made as to the accuracy or completeness of the foregoing data and safety information, nor is any authorization given or implied to practice any patented invention without license. In addition, no responsibility can be assumed by vendor for any damage or injury resulting from abnormal use, from any failure to adhere to recommended practices or from any hazards inherent in the nature of the product.

Gabe Bucca
VP Human Resources & Safety

Date