

November 2008

To: Nicholas A. Sabatini  
Associate Administrator for Aviation Safety  
AVS-1  
800 Independence Avenue, SW  
FOB 10-A, Room 1000 West  
Washington, DC 20591

cc: Dan Jenkins  
Manager, Air Carrier Training Branch  
AFS-210  
800 Independence Avenue, SW  
FOB 10-A, Room 831  
Washington, DC 20591

cc: Greg Kirkland  
Acting Manager, Air Transportation Division  
AFS-200  
800 Independence Avenue, SW  
FOB 10-A, Room 831  
Washington, DC 20591

cc: Gloria LaRoche  
Aviation Safety Inspector  
Air Carrier Training, AFS-210  
800 Independence Avenue, SW  
FOB 10-A, Room 831  
Washington, DC 20591

Dear Mr. Sabatini:

We are pleased to provide you this "Airplane Upset Recovery Training Aid Revision 2". This document was developed in response to FAA request for us to convene an industry and government working group to develop guidance to flight crews as it pertains to issues associated with operations, unintentional slowdowns, and recoveries in the high altitude environment. In the interest of defining an effective document, it has been decided to introduce this package as a supplement to the Airplane Upset Recovery Training Aid first released in 1998. While the Airplane Upset Recovery Training Aid specifically addressed airplanes with 100 seats or greater, the information in this supplement is directly applicable to most jet airplanes that routinely operate in this environment. This supplemental information has been inserted in the Airplane Upset Recovery Training Aid Rev 2 completed October 2008.

As a group of industry experts, we are confident we achieved the goal of defining a reference that will be effective to educate pilots so they have the knowledge and skill to adequately operate their airplanes and prevent upsets in a high altitude environment. The key point is that no reference material published is of value unless it is used. To that end, we implore the FAA to produce language to support implementation of this material that will motivate operators to use it. Indeed, the current Airplane Upset Recovery Training Aid serves as an excellent example of a collaborative reference produced at the insistence of the FAA, with little endorsement or requirement for implementation. The industry result is an assortment of products available with no standard reference. This competes against the very motivation for producing a collaborative document in the first place.

Several recommendations have been provided to our team from the FAA certification group. We are encouraged they continue to look at ways to improve future aircraft. We are confident this supplement and the Airplane Upset Recovery Training Aid, for airplanes in service today, are effective references, if implemented, to provide flight crews information and skills that respond to the suggestions this FAA group are studying.

Your review and agreement to the attached Training Aid will allow us to produce and deliver it to industry.

Sincerely,



Captain Dave Carbaugh  
The Boeing Company  
Co-chair Upset Recovery Industry Team



Captain Larry Rockliff  
Airbus  
Co-chair Upset Recovery Industry Team



Bob Vandell  
Flight Safety Foundation  
Co-chair Upset Recovery Industry Team

August 6, 2004

Dear Sir/Madam:

It is a pleasure to provide to you this "Airplane Upset Recovery Training Aid Revision 1". Our goal is to see it implemented within your organization and throughout the aviation industry. This training tool is the culmination of a painstaking, concentrated effort of an industry and Government working group representing a broad segment of the aviation community.

The training aid was originally released in 1998 using the same industry and Government process. These teams were composed of both domestic and international experts representing a wide range of knowledge and interests. This updated consensus document represents the most recent information available on upset recovery training. We are providing this training aid to you as a means of enhancing knowledge of, and recovery from, airplane upset situations.

The information and techniques presented in this training aid are aimed at industry solutions for large swept-wing turbofan airplanes typically seating more than 100 passengers. Other type airplanes may have characteristics that are different and guidance from the manufacturers of these types of airplanes should be followed.

The training recommended in this aid was based on the capabilities of today's modern airplanes and simulators. It is hoped that training organizations will find this material easy to adapt to their training programs and equipment. The modular design of the training allows the individual training departments to use the segments that provide benefits to their organizations. The industry team agreed that a training program that stresses academic understanding and practical simulation would provide the individual pilot the tools necessary to recover should an upset situation occur. Today's modern simulators, when kept within the boundaries of valid data, provide an adequate environment in which to perform the recommended training and exposure to upset recovery.

The incorporation of this Upset Recovery Training Aid into your training programs is strongly recommended. In order to reduce the number of loss of control accidents we must have a consistent industry standard of knowledge and training regarding airplane upset recovery. We hope the use of this training aid will help us all to improve aviation safety.

Sincerely,



Captain Dave Carbaugh  
The Boeing Company  
Co-Chair Upset Recovery Industry Team



Captain Larry Rockliff  
Airbus  
Co-chair Upset Recovery Industry Team

---

# High Altitude Operations

## *Supplement #1 to the Airplane Upset Recovery Training Aid*

*Assembled by the Industry Airplane Upset Recovery Training Aid Team, October 5, 2008*

## Table of Contents

	Page
Introduction.....	1
High Altitude Aerodynamics.....	2
L/D Max.....	2
Weight & Balance Effects on Handling Characteristics.....	6
Stalls.....	6
Altitude Exchange For Airspeed.....	7
Flight Techniques of Jet Aircraft.....	8
Additional Considerations.....	9
Exercise: High Altitude Stall Warning.....	11

### Introduction

This document is intended to supplement the Airplane Upset Recovery Training Aid Rev 1 that was released in August 2004. It addresses the issues associated with operations, unintentional slowdowns, and recoveries in the high altitude environment. While the Airplane Upset Recovery Training Aid addressed airplanes with 100 seats or greater, the information in this document is directly applicable to most all jet airplanes that routinely operate in this environment. This information has also been inserted in the Airplane Upset Recovery Training Aid Rev 2 completed October 2008. Consult the operations manual for your airplane type, as that information takes precedent to the following guidance.

An industry working group was formed to develop this guidance at the request of the U.S. Department of Transportation, Federal Aviation Administration. The working group consisted, in scope, of both domestic and international organizational representatives from the airline, manufacturer, regulatory, industry trade, and educational segments. The goal of this group was to educate pilots so they have the knowledge and skill to adequately operate their airplanes and prevent upsets in a high altitude environment. This should include the ability to

recognize and prevent an impending high altitude problem and increase the likelihood of a successful recovery from a high altitude upset situation should it occur.

This working group was formed as a result of the United States National Transportation Safety Board (NTSB) recommendations from a high altitude loss of control accident and other recent accidents and incidents that have occurred under similar conditions. The NTSB recommendations stated that pilots should possess a thorough understanding of the airplane's performance capabilities, limitations, and high altitude aerodynamics. The guidance in this document is intended to supplement the Airplane Upset Recovery Training Aid in these areas.

There have been other recent accidents where for various reasons (e.g. trying to top thunderstorms, icing equipment performance degradation, unfamiliarity with high altitude performance, etc.) crews have gotten into a high altitude slowdown situation that resulted in a stalled condition from which they did not recover. There have been situations where for many reasons (e.g. complacency, inappropriate automation modes, atmospheric changes, etc.) crews got into situations where they received an

approach to stall warning. Some of the recoveries from these warnings did not go well. This supplement is intended to discuss these possible situations, and provide guidance on appropriate training and recommendations for knowledge, recognition, and recovery.

For example, a recent incident occurred where an airplane experienced an environmental situation where airspeed slowly decayed at altitude. The crew only selected maximum cruise thrust, instead of maximum available thrust, and that did not arrest the slowdown. The crew decided to descend but delayed to get ATC clearance. Airplane slow speed buffet started, the crew selected an inappropriate automation mode, the throttles were inadvertently reduced to idle, and the situation decayed into a large uncontrolled altitude loss. This incident may easily have been prevented had the flight crew acted with knowledge of information and techniques as contained in this supplement.

In another high altitude situation, the crew decided to use heading select mode to avoid weather while experiencing turbulence. The steep bank angle that resulted from this mode quickly caused slow speed buffeting. The crew's rapid inappropriate response to disconnect the autopilot and over-control the airplane into a rapid descent in poor weather exacerbated the situation. These real world examples provide evidence towards the need for more detailed training in high altitude operations.

### **High Altitude Aerodynamics**

To cope with high altitude operations and prevent upset conditions, it is essential to have a good understanding of high altitude aerodynamics. This section represents terms and issues pilots need to understand thoroughly in order to successfully avoid upset conditions or cope with inadvertent encounters.

As a purely practical matter, it is useful to identify high altitude operations as those above flight level 250 (FL250 or 25,000 feet). The great majority of passengers and freight is now being carried in turbojet-powered airplanes, virtually all of which regularly operate at altitudes above FL250 where high speeds and best economy are attained. While aerodynamic principles and certain hazards apply at all altitudes, they become particularly significant with respect to loss of control (or upset) at altitudes above FL250. For these reasons and others, this

training aid defines high altitude as any altitude above FL250.

### **High Altitude Operations -Regulatory Issues**

The high altitude environment has a number of specific references within regulations. They include: criteria defining maximum operating altitude and service ceilings, required high altitude training, flight crew member use of oxygen, passenger briefings, airspace issues, transponder usage, and Reduced Vertical Separation Minimum (RVSM) requirements. Although this information is necessary knowledge for flight crews, this document will focus on the information necessary to prevent and recover from upsets in the high altitude environment.

There are a number of aerodynamic principles that are necessary to understand to have a good grasp of high altitude performance.

### **L/D Max**

The lowest point on the total drag curve (as indicated in figure 1) is known as L/D max (or V<sub>md</sub>-minimum drag speed). The speed range slower than L/D max is known as slow flight, which is sometimes referred-to as the "back side of the power-drag curve" or the "region of reverse command". Speed faster than L/D max is considered normal flight, or the "front side of the power-drag curve".

Normal flight (faster than L/D max) is inherently stable with respect to speed. When operating in level flight at a constant airspeed with constant thrust setting, any airspeed disturbance (such as turbulence) will result in the airspeed eventually returning to the original airspeed when the total thrust has not changed.

Slow flight (slower than L/D max) is inherently unstable with respect to speed and thrust settings. When operating at a constant airspeed with constant thrust setting, any disturbance causing a decrease in airspeed will result in a further decrease in airspeed unless thrust is increased. As in Figure 1, the lower speed will subject the airplane to increased drag. This increase in drag will cause a further decrease in airspeed, which may ultimately result in a stalled flight condition. Flight slower than L/D max at high altitudes must be avoided due to the inefficiency and inherent instability of the slow flight speed range. When operating slower than L/D max, and where total drag exceeds total thrust, the airplane

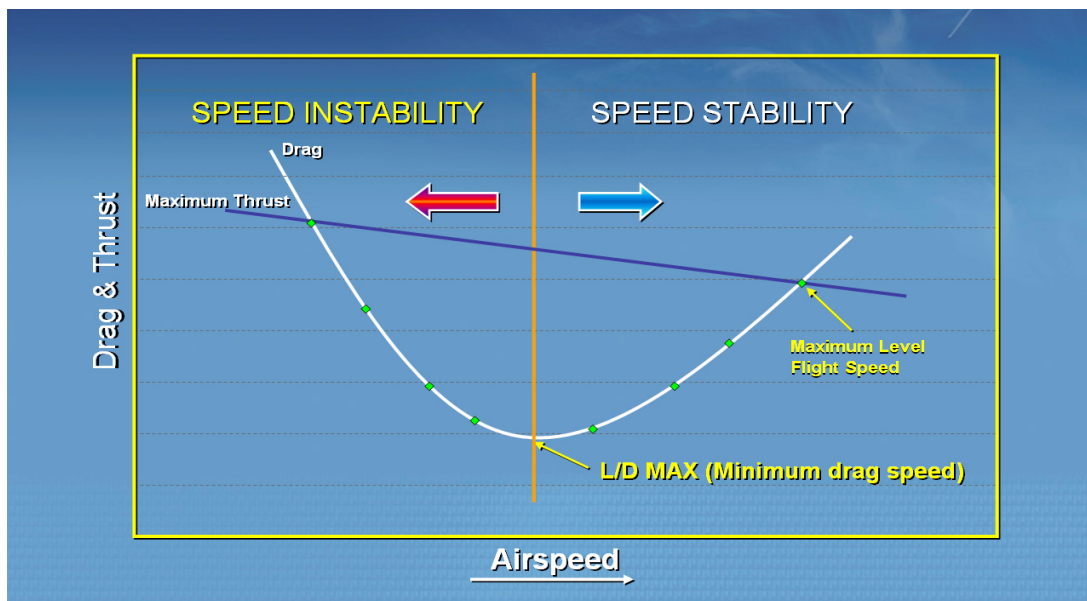

Figure 1.  
Airspeed versus drag  
in level flight

will be unable to maintain altitude and the only remaining option to exit the slow flight regime is to initiate a descent.

External factors, such as changing winds, increased drag in turns, turbulence, icing or internal factors, such as anti-ice use, auto-throttle rollback, or engine malfunction or failure can cause airspeed decay. Heavily damped auto-throttles, designed for passenger comfort, may not apply thrust aggressively enough to prevent a slowdown below L/D max.

Slower cruising speeds are an issue. As airplanes are pushed to more efficient flight profiles to save fuel, it may dictate high altitude cruising at lower Mach numbers. The net result is the crew may have less time to recognize and respond to speed deterioration at altitude.

At all times, pilots must ensure that flight slower than L/D max is avoided in the high altitude environment. Proper flight planning and adherence to published climb profiles and cruise speeds will ensure that speeds slower than L/D max are avoided.

As an airplane climbs and cruises at high altitude, flight crews should be aware of terms that affect them.

#### Crossover Altitude

Crossover Altitude is the altitude at which a specified CAS (Calibrated airspeed) and Mach value represent the same TAS (True airspeed) value. Above this altitude the Mach number is used to

reference speeds.

#### Optimum Altitude

Optimum Altitude is defined as an altitude at which the equivalent airspeed for a thrust setting will equal the square root of the coefficient of lift over the coefficient of drag. In less technical terms, it is the best cruise altitude for a given weight and air temperature. A dramatic increase in temperature will lower the optimum altitude. Therefore, when flying at optimum altitude, crews should be aware of temperature to ensure performance capability.

#### Optimum Climb Speed Deviations

Airplane manuals and flight management systems produce optimum climb speed charts and speeds. When increased rates of climb are required, ensure speed is not decreased below L/D max. Evidence shows that inappropriate use of vertical speed modes is involved in the majority of slow speed events during high altitude climbs.

#### Thrust Limited Condition and Recovery

Most jet transport airplanes are thrust limited, rather than low speed buffet limited, at altitude, especially in a turn. It is imperative that crews be aware of outside temperature and thrust available. To avoid losing airspeed due to a thrust limit, use flight management systems/reduced bank angle as a routine for en-route flight if it incorporates real-time bank angle protection, or routinely select a bank angle limit of 10-15 degrees for cruise flight. If a

---

condition of airspeed decay occurs at altitude, take immediate action to recover:

- Reduce bank angle
- Increase thrust – select maximum continuous thrust if the airplane’s auto-throttle system is maintaining thrust at a lower limit
- Descend

If a high drag situation occurs where maximum available thrust will not arrest the airspeed decay, the only available option is to descend.

### **Maximum Altitude**

Maximum altitude is the highest altitude at which an airplane can be operated. In today’s modern airplanes it is determined by three basic characteristics which are unique to each airplane model. It is the lowest of:

- Maximum certified altitude (structural) that is determined during certification and is usually set by the pressurization load limits on the fuselage.
- Thrust Limited Altitude – the altitude at which sufficient thrust is available to provide a specific minimum rate of climb.
- Buffet or Maneuver limited altitude – the altitude at which a specific maneuver margin exists prior to buffet onset.

Although each of these limits is checked by modern flight management computers the available thrust may limit the ability to accomplish anything other than relatively minor maneuvering.

The danger in operating near these ceilings is the potential for the speed and angle of attack to change due to turbulence or environmental factors that could lead to a slowdown or stall and subsequent high altitude upset.

In early turbojet era airplanes the capability to reach what is called absolute ceiling or “coffin corner” could exist. This is where if an airplane flew any slower it would exceed its stalling angle of attack and experience low speed buffet. Additionally, if it flew any faster it would exceed Mmo, potentially leading to high speed buffet.

All airplanes are equipped with some form of stall warning system. Crews must be aware of systems installed on their airplanes (stick pushers, shakers, audio alarms, etc.) and their intended function. In a high altitude environment, airplane buffet is sometimes the initial indicator of problems.

### **Maneuvering Stability**

For the same control surface movement at constant airspeed, an airplane at 35,000 ft experiences a higher pitch rate than an airplane at 5,000 ft because there is less aerodynamic damping. Therefore, the change in angle of attack is greater, creating more lift and a higher load factor. If the control system is designed to provide a fixed ratio of control force to elevator deflection, it will take less force to generate the same load factor as altitude increases.

An additional effect is that for a given attitude change, the change in rate of climb is proportional to the true airspeed. Thus, for an attitude change for 500 ft per minute (fpm) at 290 knots indicated air speed (KIAS) at sea level, the same change in attitude at 290 KIAS (490 knots true air speed) at 35,000 ft would be almost 900 fpm. This characteristic is essentially true for small attitude changes, such as the kind used to hold altitude. It is also why smooth and small control inputs are required at high altitude, particularly when disconnecting the autopilot.

Operating limits of modern transport category airplanes are designed so that operations within these limits will be free of adverse handling characteristics. Exceeding these limits can occur for various reasons and all modern transport airplanes are tested to allow normal piloting skill to recover these temporary exceedences back to the normal operational envelope. It is imperative to not overreact with large and drastic inputs. There is no need to take quick drastic action or immediately disconnect a correctly functioning autopilot. Pilots should smoothly adjust pitch and/or power to reduce speed should an overspeed occur.

In the high altitude flight area there is normally adequate maneuver margin at optimum altitude. Maneuver margin decreases significantly as the pilot approaches maximum altitude. Flying near maximum altitude will result in reduced bank angle capability; therefore, autopilot or crew inputs must be kept below buffet thresholds. The use of LNAV will ensure bank angle is limited to respect buffet and thrust margins. The use of other automation modes, or hand flying, may cause a bank angle that result in buffeting. When maneuvering at or near maximum altitude there may be insufficient thrust to maintain altitude and airspeed. The airplane may initially be within the buffet limits but does not have sufficient thrust to maintain the necessary airspeed. This is a common item in many high altitude situations where airplanes slow down to

the lower buffet limits. These situations can be illustrated with performance charts.

Figure 2 shows a typical transport category airplane optimum and maximum altitude capability. When temperature increases the maximum altitude capability decreases significantly. This is a situation where maneuver buffet margins are adequate but temperature is affecting thrust capability to sustain airspeed at the higher altitudes.

Figure 3 shows that for normal cruise speeds there is excess thrust available at this fixed weight and altitude. When trying to turn using 30 degrees of bank, the drag exceeds the normal maximum cruise thrust limit. If the pilot selects maximum continuous thrust (MCT) then there is enough thrust to maintain the bank angle in the same situation.

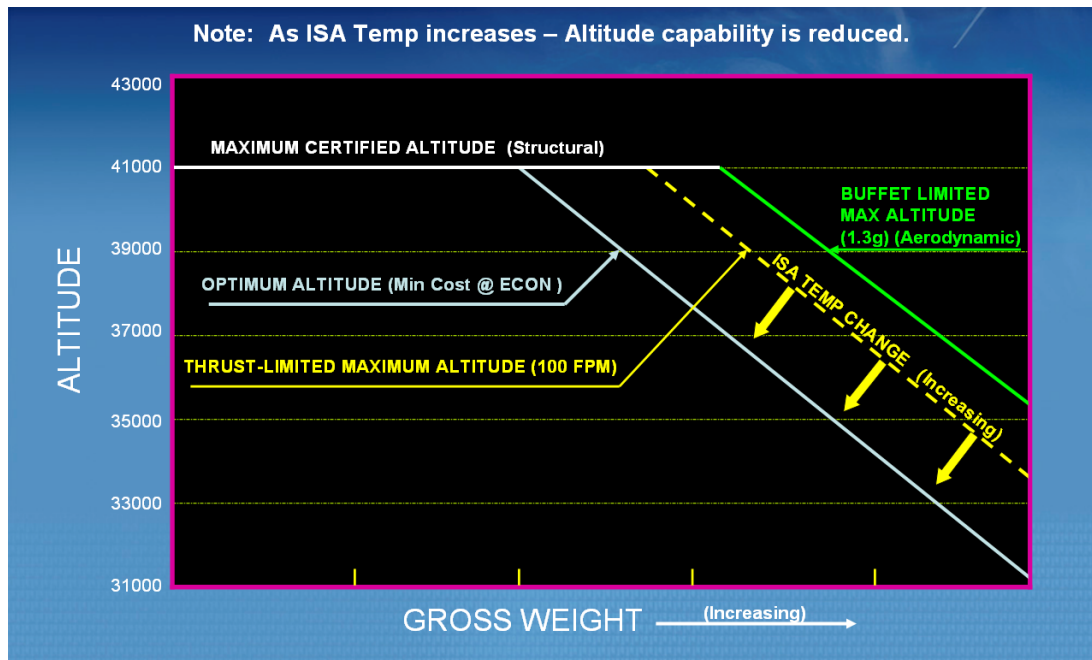

Figure 2. Typical optimum versus maximum altitude

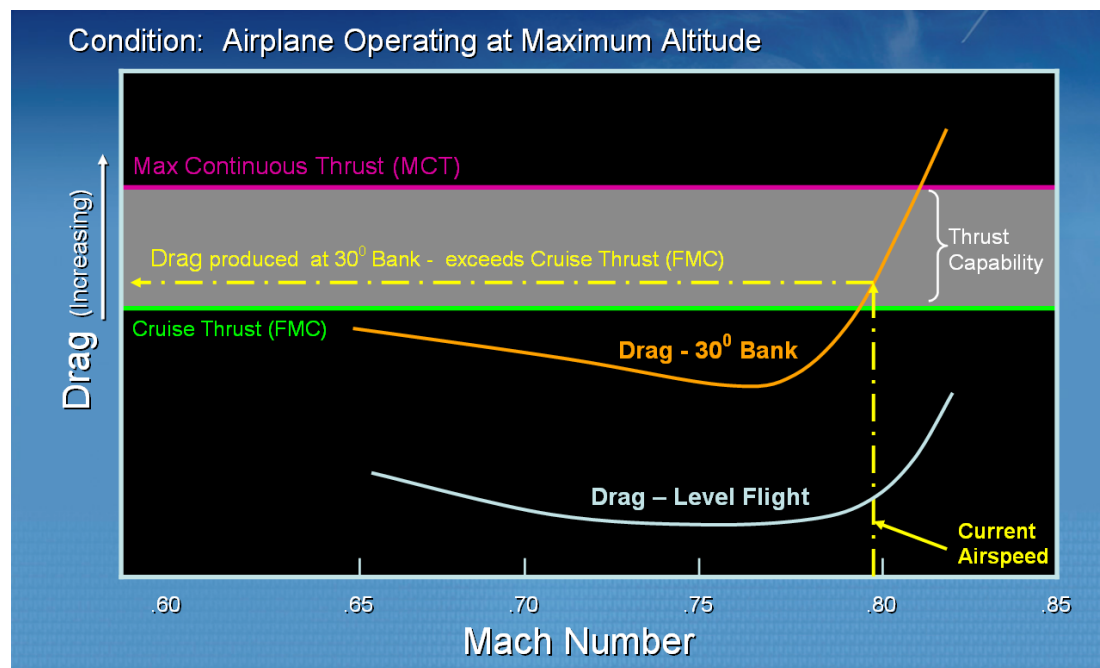

Figure 3. Drag reduced by bank versus available thrust

---

## **Weight & Balance Effects on Handling Characteristics**

Weight and Balance limitations must be respected. An airplane that is loaded outside the weight and balance envelope will not exhibit the expected level of stability and will result in aircraft handling that is unpredictable and may not meet certification requirements. This is a serious issue, particularly in an aft loading situation where stall recovery may be severely affected. The problem may be exacerbated at high altitude.

At high altitude, an aft loaded airplane will be more responsive to control pressures since it is less stable than a forward loading. Of interest to pilots is that the further aft an airplane is loaded, less effort is required by the tail to counteract the nose down pitching moment of the wing. The less effort required by the tail results in less induced drag on the entire airplane which results in the most efficient flight. Some airline load planning computers attempt to load airplane as far aft as possible to achieve efficiency. Some advanced airplanes use electronic controls to help improve airplane handling with aft loading.

### **Mach Tuck and Mach Buffet**

In some airplanes, at speeds above  $M_{mo}$ , a phenomenon called mach tuck will occur. Above critical Mach number the speed of an airplane at which airflow over any part of the wing first reaches Mach 1.0 a shock wave will begin to form on the wing and mach buffet will occur. Mach buffet will continue to increase with increased speed and the aft movement of the shock wave, the wing's center of pressure also moves aft causing the start of a nose-down tendency or "tuck." Because of the changing center of lift of the wing resulting from the movement of the shock wave, the pilot will experience pitch down tendencies. In modern transport airplanes this phenomenon has been largely eliminated.

### **Buffet-Limited Maximum Altitude**

There are two kinds of buffet to consider in flight; low speed buffet and high speed buffet. As altitude increases, the indicated airspeed at which low speed buffet occurs increases. As altitude increases, high speed buffet speed decreases. Therefore, at a given weight, as altitude increases, the margin between high speed and low speed buffet decreases.

Proper use of buffet boundary charts or maneuver

capability charts can allow the crew to determine the maximum altitude that can be flown while still respecting the required buffet margins.

At high altitudes the excess thrust available is limited. Crews must be aware that additional thrust is available by selecting maximum available/continuous thrust at any time. However, in extreme airspeed decay situations MCT may be insufficient. Proper descent techniques will be necessary in order to prevent further airspeed decay into an approach to stall and stall situation.

## **Stalls**

Fundamental to understanding angle of attack and stalls is the realization that an airplane wing can be stalled at any airspeed and any altitude. Moreover, attitude has no relationship to the aerodynamic stall. Even if the airplane is in descent with what appears like ample airspeed, the wing surface can be stalled. If the angle of attack is greater than the stall angle, the surface will stall.

Most pilots are experienced in simulator or even airplane exercises that involve approach to stall. This is a dramatically different condition than a recovery from an actual stall because the technique is not the same. The present approach to stall technique being taught for testing is focused on "powering" out of the near-stalled condition with emphasis on minimum loss of altitude. At high altitude this technique may be totally inadequate due to the lack of excess thrust. It is impossible to recover from a stalled condition without reducing the angle of attack and that will certainly result in a loss of altitude, regardless of how close the airplane is to the ground. Although the thrust vector may supplement the recovery it is not the primary control. At stall angles of attack, the drag is very high and thrust available may be marginal. Also, if the engine(s) are at idle, the acceleration could be very slow, thus extending the recovery. At high altitudes, where the available thrust is reduced, it is even less of a benefit to the pilot. The elevator is the primary control to recover from a stalled condition, because, without reducing the angle of attack, the airplane will remain in a stalled condition until ground impact, regardless of the altitude at which it started.

Effective stall recovery requires a deliberate and smooth reduction in wing angle of attack. The elevator is the primary pitch control in all flight conditions, not thrust.



---

## Altitude Exchange For Airspeed

Although stall angle of attack is normally constant for a given configuration, at high altitudes swept wing turbojet airplanes may stall at a reduced angle of attack due to Mach effects. The pitch attitude will also be significantly lower than what is experienced at lower altitudes. Low speed buffet will likely precede an impending stall. Thrust available to supplement the recovery will be dramatically reduced and the pitch control through elevator must be used. The goal of minimizing altitude loss must be secondary to recovering from the stall. Flight crews must exchange altitude for airspeed. Only after positive stall recovery has been achieved, can altitude recovery be prioritized.

An airplane is stalled when the angle of attack is beyond the stalling angle. A stall is characterized by any of, or a combination of, the following:

- a. Buffeting, which could be heavy at times
- b. A lack of pitch authority
- c. A lack of roll control.
- d. Inability to arrest descent rate.

These characteristics are usually accompanied by a continuous stall warning.

### Weather effects that could cause a slowdown or stall at high altitudes

At high altitudes the upper air currents such as the jet-stream become significant. Velocities in the jet-stream can be very high and can present a beneficial tailwind or a troublesome headwind. Windshear at the boundaries of the jet-stream can cause severe turbulence and unexpected changes in airspeed or Mach number. This windshear, or other local disturbances, can cause substantial and immediate airspeed decreases in cruise, as well as climb situations. If the airplane is performance limited due to high altitude and subsequently encounters an area of decreasing velocity due to wind shear, in severe cases the back side of the power curve may be encountered. The pilot will have to either increase thrust or decrease angle of attack to allow the airspeed to build back to normal climb/cruise speeds. This may require trading altitude for airspeed to accelerate out of the backside of the power curve region if additional thrust is not available.

### ICING – Use of Anti-Ice on Performance

Pilots must understand that occasionally icing does occur at high altitudes and they must be prepared to

use anti-ice. Careful monitoring of flight conditions is critical in this decision making.

Appropriate and judicious use of anti-ice equipment at high altitude is very important. One must be aware of the fact that the use of anti-ice has a negative effect on the available thrust. In some cases, it may not be possible to maintain cruise speed or cruise altitude at high altitude with anti-ice on. Pilots should also be aware of the specific flight planning parameters for their particular flight.

### In-flight Icing Stall Margins

In-flight icing is a serious hazard. It destroys the smooth flow of air on the airplane, increasing drag, degrading control authority and decreasing the ability of an airfoil to produce lift. The airplane may stall at much higher speeds and lower angles of attack than normal. If stalled, the airplane can roll or pitch uncontrollably, leading to an in-flight upset situation.

Even with normal ice protection systems operating properly, ice accretion on unprotected areas of the airplane may significantly increase airplane weight and drag.

Activation of an artificial stall warning device, such as a stick shaker, is typically based on a pre-set angle of attack. This setting gives a warning prior to actual stall onset where buffeting or shaking of the airplane occurs. For a clean airplane, the pilot has adequate warning of impending stall. However, with ice, an airplane may exhibit stall onset characteristics before stick shaker activation because of the effect of ice formations on reducing the stall angle-of-attack. In this case, the pilot does not have the benefit of a stick shaker or other stall warning.

Flight crews must be especially wary of automation during icing encounters. Autopilots and auto-throttles can mask the effects of airframe icing and this can contribute to ultimate loss of control. There have been several accidents in which the autopilot trimmed the airplane right to a stall upset situation by masking heavy control forces. If the autopilot disengages while holding a large roll command to compensate for an asymmetric icing condition (or other similar problem causing roll), an immediate large rolling moment ensues for which the pilot may not be prepared, resulting in a roll upset. Pilots have been surprised when the autopilot automatically disconnected with the airplane on the brink of a stall.

---

Some autopilots are designed with control laws that enable them to continue to operate until they get to stick shaker. Alternatively, the autopilot may disconnect early because of excessive roll rates, roll angles, control surface deflection rates, or forces that are not normal. These autopilots are not malfunctioning; they are working as designed.

High altitude weather can cause favorable conditions for upsets. Thunderstorms, clear air turbulence, and icing are examples of significant weather that pilots should take into consideration in flight planning. Careful review of forecasts, significant weather charts, turbulence plots are key elements in avoiding conditions that could lead to an upset.

Once established in cruise flight, the prudent crew will update weather information for the destination and enroute. By comparing the updated information to the preflight briefing, the crew can more accurately determine if the forecast charts are accurate. Areas of expected turbulence should be carefully plotted and avoided if reports of severe turbulence are received. Trend monitoring of turbulence areas is also important. Trends of increasing turbulence should be noted and if possible avoided. Avoiding areas of potential turbulence will reduce the risk of an upset.

#### **Primary Flight Display Airspeed Indications**

Modern airplanes that are equipped with a primary flight display (PFD) provide information that will help maintain a safe airspeed margin between the low and high speed limits. Most of these airplanes have an indication of airspeed trending. This is important because these displays do not indicate if adequate thrust is available at that altitude to maintain the current airspeed. Older airplanes have charts in the performance section that depict adequate speed ranges for a given altitude and weight.

#### **Flight Techniques of Jet Aircraft**

Now that we are familiar with terms and aerodynamics of high altitude operations, certain techniques will now be discussed that will aid in eliminating high altitude upsets.

#### **Automation During High Altitude Flight**

During cruise at high altitude the autopilot will be engaged with the pitch in an altitude hold mode and the throttles in a speed mode. However, it is

possible that due to changing conditions (increasing temperature, mountain wave, etc.) or poor planning, an airplane could be thrust limited and not be able to maintain the desired altitude and/or airspeed. Regardless, the airplane's automatic control system will try to maintain this altitude by increasing thrust to its selected limit. When the thrust is at the maximum limit the pitch may continue to increase to maintain altitude and the airspeed then continues to decay. The only option then is to descend. The pilot's action should be to pitch down and increase the airspeed while being in an automation mode that keeps the throttles at maximum thrust. If the autopilot is still engaged, select a lower altitude and use an appropriate mode to start the aircraft down. However, if the aircraft is not responding quickly enough you must take over manually. Pilots must assess the rate at which vertical speed and airspeed increase is occurring to make this determination. This does not imply that aggressive control inputs are necessary. The autopilot can then be reengaged once the airplane is in a stable descent and the commanded speed has been reestablished. Do not attempt to override the autopilot, it is always better to disconnect it before making manual control inputs. Due to RVSM considerations and large altitude losses, crews should consider turning off course during descents and monitoring TCAS to reduce the potential for collisions. Crews should also inform ATC of their altitude deviations.

The consequences of using Vertical Speed (VS) at high altitude must be clearly understood. Most autoflight systems have the same logic for prioritizing flight path parameters. The fundamental aspect of energy management is to manage speed by either elevator or with thrust. When using the VS mode of the Auto Flight System (AFS), airplane speed is normally controlled by thrust. If a too high vertical descent rate is selected the autothrottle will reduce thrust to idle and the airspeed will start to increase above the commanded airspeed. The reverse situation can occur with considerable risk if an excessive climb rate is selected. In that case, if the thrust available is less than the thrust required for that selected vertical speed rate the commanded speed will not be able to be held and a speed decay will result. On some airplanes, improper use of VS can result in speed loss and eventually a stall.

Pilots must understand the limits of their airplanes when selecting vertical modes. As a general guideline, VS should not be used for climbing at high altitudes. Reduced thrust available at high altitudes

---

means that speed should be controlled through pitch and not with thrust. VS can be used for descent; however, selecting excessive vertical speeds can result in airspeed increases into an overspeed condition. Using a mode that normally reduces thrust, when the need arises to descend immediately, may not be appropriate for a low speed situation. Either disconnect autothrottles, or use a mode that keeps the throttles at maximum available thrust in these situations.

### **Human Factors and High Altitude Upsets**

The flightcrew may be startled by unexpected low airspeed stall warnings, dynamic buffeting and large changes in airplane attitude (design dependent) especially when the airplane is on autopilot. While flightcrews receive training on systems such as stick shakers to alert the pilots of impending stall, normally they do not receive training in actual full stall recovery, let alone stall recovery at high altitudes. Hence, flight crews are inclined to respond to high altitude stalls like they have been trained to respond to stall warnings, but the procedures for the latter are neither effective nor proper for stall recovery. Furthermore, unlike the conditions for which the flightcrew is trained to respond to stall warnings at lower altitudes, at the higher altitudes the available thrust is insufficient, alone, to recover from a stall. The only effective response is to reduce the angle of attack and trade altitude for airspeed. Pilots have also reported that low airspeed buffet was mistaken for high speed buffet which prompts an incorrect response to reduce airspeed when approaching a low airspeed stall. As in any emergency situation, if the airplane is designed with effective alerting (actual and/or artificial) and the flightcrew is adequately trained to recognize the indicators of the stall, these will lead to appropriate flight crew recovery actions as discussed in the next paragraph. Equally important is that crews be familiar with stall warning and recognition devices, such as stick pushers, in order to understand their operation.

Once the pilot recognizes the airplane is in a full aerodynamic stall, immediate corrective actions and decisions required for airplane recovery are sometimes delayed by the flightcrew. Some of the reasons for the delay include 1) lack of situational awareness and crew confusion, 2) anxiety associated with altitude violations and maintaining separation from other air traffic, 3) previous training emphasizing prevention of altitude loss of only a few hundred

feet even in the case of an impending high altitude stall, 4) inadequate experience with high altitude manual flight control, and 5) concern for passenger and crew safety. While the magnitude of required flight control input will vary by airplane design for recovery, flightcrews should be trained to expect a longer recovery time and greater altitude loss, often thousands of feet, while the airplane accelerates to gain airspeed following high altitude stall

Also, since there is no detailed checklist or procedure telling the pilot when to start the stall recovery and how much back pressure should be used for return to level flight after stall recovery, these techniques need to be adequately trained. For example during stall recovery, pilots gauge how assertively they can pull back by using stick shaker activation to indicate when to reduce back pressure. Other pilots may use angle of attack limit indications on the attitude indicator (if equipped) to aid in the stall recovery. Pilots should also be aware that an aggressive stall recovery and subsequent altitude recapture can result in a secondary stall during stall recovery as the pilot discovers the correct level of control inputs required to recover the airplane. On the other side there is the concern of accelerating into high speed buffet during the recovery if the airplane is allowed to accelerate too much.

### **Additional Considerations**

#### **Multi-Engine Flame Out**

At high altitudes, as a result of very low airspeed, stall conditions, or other occurrences an all engine flameout may occur. This is easily detected in cruise but may be more difficult to detect during a descent. The all engine flameout demands prompt action regardless of altitude and airspeed. After recognition, immediate accomplishment of the recall items and/or checklist associated with the loss of all engines is necessary to quickly establish the appropriate airspeed (requires a manual pitch down) and to attempt a windmill relight. It should be noted that loss of thrust at higher altitudes (above 30,000 feet) may require driftdown to a lower altitude to improve windmill starting capability. Additionally, even though the inflight start envelope is provided to identify the region where windmill starts can occur, it is often demonstrated during certification this envelope does not define the only areas where a windmill start may be successful. Regardless of the conditions and status of the airplane, strict adherence to the checklist is essential to maximize

---

the probability of a successful relight.

### **Core Lock**

Core lock is a phenomenon that could, in theory, occur in any turbine engine after an abnormal thermal event (e.g. a sudden flameout at low airspeed) where the internal friction exceeds the external aerodynamic driving forces and the “core” of the engine stops. When this occurs, differential contraction of the cooler outside case clamps down on the hotter internal components (seals, blade tips etc.) preventing rotation or “locking the core.” This seizure may be severe enough to exceed the driving force available by increasing airspeed or from the starter. If differential cooling locks the core, only time will allow the temperature difference to equalize, reduce the contact friction caused by differential contraction and allow free rotation.

After all engine flameouts, the first critical item is to obtain safe descent speed. Then flight crews need to determine engine status. If any of the engine spools indicate zero RPM then a situation of core lock may exist or mechanical engine damage could have occurred. If this case applies to all engines, crews must obtain best L/D airspeed instead of accelerating to windmill speed, to obtain an optimum glide ratio. Crews then should consider their forced landing options. In the event the seized spool(s) begin to rotate a relight will be contemplated and windmill airspeed may be necessary.

### **Rollback**

Turbine engine rollback is an uncommon anomaly consisting of an uncommanded loss of thrust (decrease in EPR or N1), which is sometimes accompanied by an increase in EGT. Rollback can be caused by a combination of many events including moisture, icing, fuel control issues, high angle of attack disrupted airflow, and mechanical failure and usually results in flameout or core lockup. Modern airplanes alleviate most rollback issues with auto-relight. Additionally, updated progressive maintenance programs identify potential problems and help to decrease rollback events. It is conceivable that pilots would recognize the results of rollback rather than the rollback event itself depending on workload and flight experience. If airspeed stagnation occurs, checking of appropriate thrust levels is important as well as increasing airspeed in the case where an engine has rolled back.

### **High Altitude Loft Scenario**

The following example loft scenario is recommended by industry as a way of familiarizing crews with high altitude slowdowns and approach to stall. Crews should always recover at the first indication of an impending stall. Operators may want to modify this scenario for the specific airplane models flown.

## High Altitude Stall Warning

<p><b>Lesson:</b> High Altitude Stall Warning</p> <p><b>Lesson Type:</b> Train to Proficiency</p> <p><b>Minimum Device:</b> Full Flight Simulator</p>	<p><b>Performance Package:</b> TBD</p> <p><b>Pre-Brief Time:</b> TBD</p> <p><b>Preparation Time:</b> TBD</p> <p><b>Sim Time:</b> TBD</p> <p><b>Preparations Time:</b> TBD</p> <p><b>De-Brief Time:</b> TBD</p>
<p><b>Introduction:</b></p>	<p>The purpose of this LOFT training aid is to assist operators of high altitude jet airplanes. The high altitude slowdown to an approach to stall represents a threat that has resulted in accidents and incidents when mismanaged. This simulator training is to assist crews in managing this threat. The exercise is not intended to train an actual jet upset or full stall, it only has the airplane reach the indications of an approach to stall before a recovery is initiated. Operators should consider a number of factors to determine how realistic their simulator will respond to this training scenario. Operators should determine the optimum manner to set up this scenario to achieve the goals of the training.</p>
<p><b>Goals of Training:</b></p>	<ol style="list-style-type: none"> <li>1. Reinforce understanding of applicable high altitude characteristics</li> <li>2. Assess how to determine cruise altitude capability</li> <li>3. Reinforce acceptable climb techniques and acknowledge the risks associated with various climb scenarios and in particular vertical speed</li> <li>4. Recognize cues of an approach to stall and indications observable prior to that point</li> <li>5. Discuss automation factors such as mode protections, hazards of split automation (where either autopilot or autothrottle is disconnected) and inappropriate modes</li> <li>6. Address intuitive and incorrect reactions to stall warning indications</li> <li>7. Develop procedures that are widely accepted to recover from impending high altitude stall conditions with and without auto-flight systems</li> </ol>
<p><b>Introductory Notes:</b></p>	<p>The crew begins this lesson in cruise flight with an airplane at an altitude of FL250 or above in a near maximum altitude situation. The airplane weight should be at or near the maximum for that altitude based upon company or manufacturer's procedures. The crew should discuss performance capability and reference applicable resources to determine what the maximum altitude is for the weight and environmental conditions. These references could include cruise charts, FMS optimum and FMS maximum altitudes with various mode protections (lateral and vertical) available. Buffet margins should be referenced and discussed based on the altitude. Alternative climbing modes and their associated hazards should be understood. Common errors include complacency with climb and cruise procedures as well as a lack of knowledge with cruise charts.</p>

**Setup and Limitations:**

The simulator will then be either positioned or flown inappropriately to a situation where with an increase in ISA temperature will cause the airplane to be behind the power curve due to changing ambient conditions. The early addition of maximum available thrust should be discussed as a necessity to prevent this situation from occurring. However, in this situation maximum thrust is not enough to keep from slowing down while maintaining altitude. Certain airplane features, either with automation or without, may prevent an approach to stall from occurring. However, indications of such an impending situation should be discussed. These include airspeed trends, symbology/warning changes, low speed indications, trim changes, etc. Auto thrust or autopilot may have to be disconnected to provide the approach to stall indications, but the goal should be to keep those modes in operation if possible to simulate a real scenario. Instructors should discuss the system degradation that results in this situation and the associated hazards. If unable to produce desired effect, reducing thrust may be necessary.

**Recognition and Recovery**

Brief interactive discussions of impending stall warning recovery methods followed by an actual stall warning recovery. Instructors should ensure the crews recover at the first indication of an approach to stall (mode reversion, aural; shaker, pusher warnings, buffet, etc). Do not allow the airplane to stall or the situation to progress to an upset situation because simulator realism may be compromised in this condition. Emphasis should be placed that the recovery requires maximum thrust and the reduction of pitch to lower the angle of attack and allowing the airplane to accelerate. At these altitudes and weight/temperature combinations, a descent will be required. If the autoflight systems are used, appropriate modes should be used that meet the objectives of maximum thrust and a smooth decrease in pitch and a descent to an appropriate altitude that allows acceleration to normal and sustainable cruise speed. If manual flight is used, smooth control inputs avoiding abrupt control actions and maximum thrust are necessary. Pilots should be aware that with the increased true airspeed larger changes will occur for the same amount of pitch change as used at lower altitudes. Common errors include incorrect recovery technique. Repeat scenario as necessary time permitting.

The crew begins this lesson in cruise flight with an airplane at an altitude of FL250 or above. The airplane weight should be at or near the maximum for that altitude based upon company or manufacturer’s procedures. Ensure crew references applicable cruise charts to determine what the maximum altitude is for the weight and environmental conditions. IOS: Instructor operating system or simulator control panel

1. IOS»POSITION SET»FL 250 or ABOVE
2. IOS»AIRPLANE SET»  
Gross weight: MAX appropriate
3. IOS»ENVIRONMENT SET»  
Weather: As desired  
DAY or NIGHT  
29.92 or STANDARD  
Winds: As desired  
OAT»ISA or as initially required for scenario

Element	Information / check for
<b>Cruise Flight</b>	<ul style="list-style-type: none"> <li>• Ask crew if they can take the next higher flight level (take note of VNAV max altitude)</li> <li>• Review the use of vertical speed/ other climb modes in climbs and what are the caveats</li> <li>• Ensure crew understands how to determine MAX cruise altitude from Flight Management System (if applicable) as well as supporting documents or manuals (e.g. Performance Manual, QRH, FCOM, etc.)</li> <li>• Ensure crew understands what their buffet margin is for the current altitude and weight combination.</li> <li>• Review different scenarios leading to high altitude stalls and upset conditions. For each scenario, review recovery procedures.</li> <li>• Set or maneuver simulator to situation that is behind the power curve such that a slowdown will occur regardless of thrust setting, with increased ISA</li> </ul>
IOS» Take a “snap shot” or save the current phase and position of flight if available to permit repetition of conditions and training	
IOS»Increase OAT as appropriate to simulate flight into warmer conditions	
<b>Airspeed Decay</b>	<ul style="list-style-type: none"> <li>• Ask crew to disengage auto thrust (only if applicable/required).</li> <li>• Instructor may have remove power from certain aircraft specific systems (e.g. flight computers) to permit aircraft to encounter a stall warning. Autopilot use may be lost.</li> <li>• Instructor may have to set thrust that produces, along with temperature increase, a slow loss in airspeed.</li> <li>• Explain to crew how the aircraft reacts with the Autopilot on and its attempt to maintain altitude.</li> <li>• Explain to crew how the aircraft reacts with the Autopilot on and its attempt to maintain altitude.</li> <li>• Point out airspeed trend and instrument indications (low speed indications/symbolology if applicable)</li> <li>• Explain what the aircraft specific threats that will be encountered with various automation situations (split automation, LNAV vs. heading select modes, etc.)</li> </ul>

<b>Stall Warning</b>	<ul style="list-style-type: none"> <li>• Explain to crew what the stall warning system uses to set off warning and in what progression the alerts will take place (visual, aural, shaker, pusher, buffet, etc.).</li> <li>• Make sure crew understands that recovery will begin at first level of warning.</li> </ul>
<b>Recovery (Autoflight)</b>	<ul style="list-style-type: none"> <li>• Crew should command a desirable (down) vertical speed into the auto-flight system. E.g. (-1000ft/min)</li> <li>• Speed should be crew selected to avoid any thrust reduction by auto-flight system</li> <li>• Ensure thrust DOES NOT reduce to idle or below desired setting</li> <li>• Monitor TCAS and SCAN for traffic conflicts</li> <li>• Notify ATC</li> <li>• Crew should determine appropriate new cruising altitude (a descent of at least 1000 feet is recommended to achieve adequate acceleration).</li> </ul>
<b>Recovery (Manual)</b>	<ul style="list-style-type: none"> <li>• Crew should disengage auto-flight systems (if applicable)</li> <li>• Pitch aircraft down smoothly to establish descent, AVOID ABRUPT CONTROL INPUTS, Pilots should be aware that with the increased true airspeed larger changes will occur for the same amount of pitch change as used at lower altitudes</li> <li>• Set thrust to MAX (MAX appropriate to aircraft)</li> <li>• Accelerate to appropriate airspeed</li> <li>• Monitor TCAS and SCAN for traffic conflicts</li> <li>• Notify ATC</li> <li>• Crew should determine appropriate new cruising altitude</li> </ul>





# AIRPLANE UPSET RECOVERY

Industry Solutions for Large Swept-Wing Turbofan Airplanes Typically Seating More Than 100 Passengers

ABX Air, Inc.

A.M. Carter Associates  
(Institute for Simulation & Training)

Air Transport Association

Airbus

Air Line Pilots Association

AirTran Airways

Alaska Airlines, Inc.

All Nippon Airways Co., Ltd.

Allied Pilots Association

Aloha Airlines, Inc.

American Airlines, Inc.

American Trans Air, Inc.

Ansett Australia

Bombardier Aerospace Training Center  
(Regional Jet Training Center)

British Airways

Calspan Corporation

Cathay Pacific Airways Limited

## Training Aid

### Revision 2

Cayman Airways, Ltd.

Civil Aviation House

Continental Airlines, Inc.

Delta Air Lines, Inc.

Deutsche Lufthansa AG

EVA Airways Corporation

Federal Aviation Administration

FlightSafety International

Flight Safety Foundation

Hawaiian Airlines

International Air Transport Association

Japan Airlines Co., Ltd.

Lufthansa German Airlines

Midwest Express Airlines, Inc.

National Transportation Safety Board

Northwest Airlines, Inc.

Qantas Airways, Ltd.

SAS Flight Academy

Southwest Airlines

The Boeing Company

Trans World Airlines, Inc.

United Air Lines, Inc.

Upset Doomain Training Institute

US Airways, Inc.

Veridian

# Airplane Upset Recovery Training Aid

## Table of Contents

Section	Page
Reference	
Units of Measurement .....	v
Acronyms .....	v
Glossary .....	vii
1 Overview for Management .....	1.1
1.0 Introduction .....	1.1
1.1 General Goal and Objectives .....	1.2
1.2 Documentation Overview .....	1.2
1.3 Industry Participants .....	1.2
1.4 Resource Utilization .....	1.3
1.5 Conclusion .....	1.3
2.0 Introduction .....	2.1
2.1 Objectives .....	2.1
2.2 Definition of Airplane Upset .....	2.1
2.3 The Situation .....	2.2
2.4 Causes of Airplane Upsets .....	2.2
2.4.1 Environmentally Induced Airplane Upsets .....	2.3
2.4.1.1 Turbulence .....	2.3
2.4.1.1.1 Clear Air Turbulence .....	2.4
2.4.1.1.2 Mountain Wave .....	2.4
2.4.1.1.3 Windshear .....	2.4
2.4.1.1.4 Thunderstorms .....	2.4
2.4.1.1.5 Microbursts .....	2.5
2.4.1.2 Wake Turbulence .....	2.6
2.4.1.3 Airplane Icing .....	2.8
2.4.2 Systems-Anomalies-Induced Airplane Upsets .....	2.8
2.4.2.1 Flight Instruments .....	2.9
2.4.2.2 Autoflight Systems .....	2.9
2.4.2.3 Flight Control and Other Anomalies .....	2.9
2.4.3 Pilot-Induced Airplane Upsets .....	2.10
2.4.3.1 Instrument Cross-Check .....	2.10
2.4.3.2 Adjusting Attitude and Power .....	2.10
2.4.3.3 Inattention .....	2.10
2.4.3.4 Distraction From Primary Cockpit Duties .....	2.11
2.4.3.5 Vertigo or Spatial Disorientation .....	2.11
2.4.3.6 Pilot Incapacitation .....	2.11
2.4.3.7 Improper Use of Airplane Automation .....	2.11
2.4.3.8 Pilot Techniques—PIO Avoidance/Recovery .....	2.12
2.4.4 Combination of Causes .....	2.12
2.5 Swept-Wing Airplane Fundamentals for Pilots .....	2.12
2.5.1 Flight Dynamics .....	2.13
2.5.2 Energy States .....	2.13
2.5.3 Load Factor .....	2.14
2.5.4 Aerodynamic Flight Envelope .....	2.17

<b>Section</b>	<b>Page</b>
2.5.5	Aerodynamics.....2.18
2.5.5.1	Angle of Attack and Stall.....2.18
2.5.5.2	Camber.....2.21
2.5.5.3	Control Surface Fundamentals .....2.22
2.5.5.3.1	Spoiler-Type Devices .....2.22
2.5.5.3.2	Trim.....2.23
2.5.5.4	Lateral and Directional Aerodynamic Considerations.....2.24
2.5.5.4.1	Angle of Sideslip.....2.24
2.5.5.4.2	Wing Dihedral Effects.....2.25
2.5.5.4.3	Pilot-Commanded Sideslip .....2.26
2.5.5.4.4	Crossover Speed .....2.26
2.5.5.5	Stability.....2.27
2.5.5.6	Maneuvering in Pitch.....2.27
2.5.5.7	Mechanics of Turning Flight .....2.29
2.5.5.8	Lateral Maneuvering.....2.30
2.5.5.9	Directional Maneuvering .....2.31
2.5.5.10	Flight at Extremely Low Airspeeds .....2.34
2.5.5.11	High-Altitude Characteristics .....2.34
2.5.5.11.1	Regulatory Issues.....2.36
2.5.5.11.2	Aerodynamic Principles of High Altitude Operations.....2.36
2.5.5.11.2.1	L/D Max.....2.36
2.5.5.11.2.2	Crossover Altitude .....2.37
2.5.5.11.2.3	Optimum Altitude .....2.37
2.5.5.11.2.4	Optimum Climb Speed Deviations.....2.37
2.5.5.11.2.5	Thrust Limited Condition and Recovery .....2.37
2.5.5.11.2.6	Maximum Altitude.....2.37
2.5.5.11.2.7	Maneuvering Stability .....2.37
2.5.5.11.3	Weight & Balance Effects on Handling Characteristics.....2.39
2.5.5.11.4	Mach Tuck and Mach Buffet .....2.39
2.5.5.11.5	Buffet-Limited Maximum Altitude .....2.39
2.5.5.11.6	Stalls .....2.40
2.5.5.11.7	Icing .....2.40
2.5.5.11.8	Primary Flight Display Airspeed Indications .....2.41
2.5.5.11.9	Automation During High Altitude Flight .....2.41
2.5.5.11.10	Human Factors and High Altitude Upsets .....2.42
2.5.5.11.11	Additional Considerations .....2.42
2.5.5.11.11.1	Multi-Engine Flame Out.....2.42
2.5.5.11.11.2	Core Lock .....2.43
2.5.5.11.11.3	Rollback.....2.43
2.5.5.12	Flight at Extremely High Speeds.....2.43
2.5.5.13	Defensive, Aggressive Maneuvers .....2.44
2.6	Recovery From Airplane Upsets .....2.44
2.6.1	Situation Awareness of an Airplane Upset .....2.44
2.6.2	Miscellaneous Issues Associated With Upset Recovery.....2.45
2.6.2.1	Startle Factor.....2.45
2.6.2.2	Negative G Force.....2.45
2.6.2.3	Use of Full Control Inputs .....2.46
2.6.2.4	Counter-Intuitive Factors.....2.46
2.6.2.5	Previous Training in Nonsimilar Airplanes .....2.46
2.6.2.6	Potential Effects on Engines.....2.46
2.6.2.7	Post Upset Conditions.....2.46

Section	Page
2.6.3	Airplane Upset Recovery Techniques .....2.46
2.6.3.1	Stall .....2.47
2.6.3.2	Nose-High, Wings-Level Recovery Techniques.....2.47
2.6.3.3	Nose-Low, Wings-Level Recovery Techniques.....2.48
2.6.3.4	High-Bank-Angle Recovery Techniques .....2.49
2.6.3.5	Consolidated Summary of Airplane Recovery Techniques .....2.49
3.0	Introduction .....3.1
3.1	Academic Training Program.....3.1
3.1.1	Training Objectives .....3.2
3.1.2	Academic Training Program Modules.....3.2
3.1.3	Academic Training Syllabus.....3.2
3.1.4	Additional Academic Training Resources .....3.3
3.2	Simulator Training Program .....3.3
3.2.1	Simulator Limitations.....3.3
3.2.2	Training Objectives .....3.4
3.2.3	Simulator Training Syllabus .....3.4
3.2.4	Pilot Simulator Briefing.....3.4
3.2.5	Simulator Training.....3.5
	Airplane Upset Recovery Training Syllabus.....3.7
	Simulator Training Exercises.....3.11
	Exercise 1. Nose-High Characteristics (Initial Training).....3.13
	Exercise 1. Iteration One—Use of Nosedown Elevator .....3.13
	Exercise 1. Iteration Two—Use of Bank Angle.....3.14
	Exercise 1. Iteration Three—Thrust Reduction (Underwing-Mounted Engines).....3.15
	Exercise 1. Practice—Practice Using All Techniques .....3.15
	Exercise 2. Nose-Low Characteristics (Initial Training) .....3.17
	Exercise 2. Iteration One—Nose-Low Recovery .....3.17
	Exercise 2. Iteration Two—Accelerated Stall Demonstration .....3.18
	Exercise 2. Iteration Three—High Bank Angle/Inverted Flight.....3.19
	Exercise 3. Optional Practice Exercise .....3.21
	Exercise 3. Instructions for the Simulator Instructor .....3.21
	Exercise 4: High Altitude Stall Warning.....3.23
	Recurrent Training Exercises.....3.26
	Appendix 3-A, Pilot Guide to Airplane Upset Recovery Questions.....App. 3-A.1
	Appendix 3-B, Airplane Upset Recovery Briefing .....App. 3-B.1
	Appendix 3-C, Video Script: <i>Airplane Upset Recovery</i> .....App. 3-C.1
	Appendix 3-D, Flight Simulator Information .....App. 3-D.1
	Appendix 3-E, High Altitude Operations Presentation.....App. 3-E.i
4	References for Additional Information.....4.1
Index	.....index.1



## Units of Measurement

° degree (temperature)  
deg degree (angle)  
deg/s degrees per second  
ft feet  
ft/min feet per minute  
ft/s feet per second  
hPa hectoPascal  
hr hour  
in inch  
inHg inches of mercury  
kg kilogram  
kn knot  
m meter  
mbar millibar  
mi mile  
min minute  
nm nautical mile  
sec second

## Acronyms

ADI Attitude Direction Indicator  
AFM Approved Flight Manual  
AGL above ground level  
AOA angle of attack  
ASRS Aviation Safety Reporting System  
ATC air traffic control  
CAT clear air turbulence  
CFIT Controlled Flight Into Terrain  
CG center of gravity  
ECAMS Electronic Centralized Aircraft Monitoring System  
EICAS Engine Indicating and Crew Alerting System  
FAA Federal Aviation Administration  
GA general duration  
ICAO International Civil Aviation Organization  
ILS Instrument Landing System  
IMC instrument meteorological conditions  
MAC mean aerodynamic chord  
MSL mean sea level  
NASA National Aeronautics Space Administration  
NTSB National Transportation Safety Board  
PF pilot flying  
PFD Primary Flight Display  
PIO pilot-induced oscillation  
PNF pilot not flying  
RTO rejected takeoff  
VMC visual meteorological conditions  
VSI Vertical Speed Indicator



## Airplane Upset Recovery Glossary

Certain definitions are needed to explain the concepts discussed in this training aid. Some of the definitions are from regulatory documents or other references, and some are defined in the aid.

### Airplane Upset

An airplane in flight unintentionally exceeding the parameters normally experienced in line operations or training:

- Pitch attitude greater than 25 deg, nose up.
- Pitch attitude greater than 10 deg, nose down.
- Bank angle greater than 45 deg.
- Within the above parameters, but flying at airspeeds inappropriate for the conditions.

### Altitude (USA)

The height of a level, point, or object measured in feet above ground level (AGL) or from mean sea level (MSL).

- a. MSL altitude—Altitude expressed in feet measured from mean sea level.
- b. AGL altitude—Altitude expressed in feet measured above ground level.
- c. Indicated altitude—The altitude as shown by an altimeter. On a pressure or barometric altimeter, it is altitude as shown uncorrected for instrument error and uncompensated for variation from standard atmospheric conditions.

### Altitude (ICAO)

The vertical distance of a level, a point, or an object considered as a point, measured from mean sea level.

### Angle of Attack (AOA)

Angle of attack is the angle between the oncoming air or relative wind, and some reference line on the airplane or wing.

### Autoflight Systems

The autopilot, autothrottle, and all related systems that perform flight management and guidance.

### Camber

The amount of curvature evident in an airfoil shape.

### Ceiling

The heights above the Earth's surface of the lowest layer of clouds or obscuring phenomena that are reported as "broken," "overcast," or "obscuration," and not classified as "thin" or "partial."

### Clear Air Turbulence (CAT)

High-level turbulence (normally above 15,000 ft above sea level) not associated with cumuliform cloudiness, including thunderstorms.

### Controlled Flight into Terrain (CFIT)

An event where a mechanically normally functioning airplane is inadvertently flown into the ground, water, or an obstacle.

### Dihedral

The positive angle formed between the lateral axis of an airplane and a line that passes through the center of the wing.

### Energy

The capacity to do work.

### Energy State

How much of each kind of energy (kinetic, potential, or chemical) the airplane has available at any given time.

### Flight Crew or Flight Crew Member

A pilot, first officer, flight engineer, or flight navigator assigned to duty in an airplane during flight time.

### Flight Level

A level of constant atmospheric pressure related to a reference datum of 29.92 inches of mercury. This is stated in three digits that represent hundreds of feet. For example, flight level 250 represents a barometric altimeter indication of 25,000 ft; flight level 255, an indication of 25,500 ft.

### Flight Management Systems

A computer system that uses a large database to allow routes to be preprogrammed and fed into the system by means of a data loader. The system is constantly updated with respect to position ac-



curacy by reference to conventional navigation aids. The sophisticated program and its associated database ensures that the most appropriate aids are automatically selected during the information update cycle.

### **Flight Path**

The actual direction and velocity an airplane follows.

### **Flight Path Angle**

The angle between the flight path vector and the horizon.

### **Flight Recorder**

A general term applied to any instrument or device that records information about the performance of an airplane in flight or about conditions encountered in flight.

### **Fly-by-Wire Airplanes**

Airplanes that have electronic flight control systems

### **Instrument Landing System**

A precision instrument approach system that normally consists of the following electronic components and visual aids:

- a. Localizer.
- b. Glideslope.
- c. Outer marker.
- d. Middle marker.
- e. Approach lights.

### **Instrument Landing System Categories**

1. ILS Category I—An ILS approach procedure that provides for approach to a height above touchdown of not less than 200 ft and with runway visual range of not less than 1800 ft.
2. ILS Category II—An ILS approach procedure that provides for approach to a height above touchdown of not less than 100 ft and with runway visual range of not less than 1200 ft.
3. ILS Category III—
  - IIIA. An ILS approach procedure that provides for approach without a decision height minimum and with runway visual range of not less than 700 ft.

IIIB. An ILS approach procedure that provides for approach without a decision height minimum and with runway visual range of not less than 150 ft.

IIIC. An ILS approach procedure that provides for approach without a decision height minimum and without runway visual range minimum.

### **Instrument Meteorological Conditions**

Meteorological conditions expressed in terms of visibility, distance from cloud, and ceiling less than the minimums specified for visual meteorological conditions.

### **International Civil Aviation Organization**

A specialized agency of the United Nations whose objectives are to develop the principles and techniques of international air navigation and foster planning and development of international civil air transport.

### **Load Factor**

A measure of the acceleration being experienced by the airplane.

### **Maneuver**

A controlled variation of the flight path.

### **Mean Sea Level (MSL) Altitude**

Altitude expressed in feet measured from mean sea level.

### **Mountain Wave**

Severe turbulence advancing up one side of a mountain and down the other.

### **Newton's First Law**

An object at rest will tend to stay at rest, and an object in motion will tend to stay in motion in a straight line, unless acted on by an external force.

### **Newton's Second Law**

An object in motion will continue in a straight line unless acted on by an external force.

$$\text{Force} = \text{mass} \times \text{acceleration}$$

**Operators**

The people who are involved in all operations functions required for the flight of commercial airplanes.

**Pitch**

Movement about the lateral axis.

**Pitch Attitude**

The angle between the longitudinal axis of the airplane and the horizon.

**Roll**

Motion about the longitudinal axis.

**Sideslip Angle**

The angle between the longitudinal axis of the airplane and the relative wind as seen in a plan view.

**Stability**

Positive static stability is the initial tendency to return to an undisturbed state after a disturbance.

**Stall**

An airplane is stalled when the angle of attack is beyond the stalling angle. A stall is characterized by any of, or a combination of, the following:

- a. Buffeting, which could be heavy at times.
- b. A lack of pitch authority.
- c. A lack of roll control.
- d. Inability to arrest descent rate.

**Trim**

That condition in which the forces on the airplane are stabilized and the moments about the center of gravity all add up to zero.

**Turbulence**

Turbulent atmosphere is characterized by a large variation in an air current over a short distance.

**Visual Meteorological Conditions**

Meteorological conditions expressed in terms of visibility, distance from cloud, and ceiling equal to or better than specified minimums.

 **$V_{MCA}$** 

The minimum flight speed at which the airplane is controllable with a maximum of 5-deg bank when the critical engine suddenly becomes inoperative with the remaining engine at takeoff thrust.

**Wake Turbulence**

The condition in which a pair of counter-rotating vortices is shed from an airplane wing, thus causing turbulence in the airplane's wake.

**Windshear**

Wind variations at low altitude

**Yaw**

Motion about the vertical axis





# Overview for Management Table of Contents

# 1

<b>Section</b>	<b>Page</b>
1.0 Introduction .....	1.1
1.1 General Goal and Objectives .....	1.2
1.2 Documentation Overview .....	1.2
1.3 Industry Participants .....	1.2
1.4 Resource Utilization .....	1.3
1.5 Conclusion .....	1.3



# Overview for Management

# 1

## 1.0 Introduction

Airplane manufacturers, airlines, pilot associations, flight training organizations, and government and regulatory agencies have developed this training resource. The training package consists of this document and a supporting video. It is dedicated to reducing the number of accidents caused by the loss of control of large, swept-wing airplanes that results from airplane upset. Airplane upset is defined as an airplane in flight unintentionally exceeding the parameters normally experienced in line operations or training.

While specific values may vary among airplane models, the following unintentional conditions generally describe an airplane upset:

- Pitch attitude greater than 25 deg, nose up.
- Pitch attitude greater than 10 deg, nose down.
- Bank angle greater than 45 deg.
- Within the above parameters, but flying at airspeeds inappropriate for the conditions.

Accidents that result from loss of airplane control have been and continue to be a major contributor to fatalities in the worldwide commercial aviation industry. Industry statistical analysis indicates there were 22 in-flight, loss-of-control accidents between 1998 and 2007.<sup>1</sup> These accidents resulted in more than 2051 fatalities. Data also suggests there are an even larger number of “incidents” where airplanes were upset. There were many reasons for the control problems; problems have been attributed to environment, equipment, and pilots. These data suggest that pilots need training to cope with airplane upsets. Research by some operators has indicated that most airline pilots rarely experience airplane upsets during their line flying careers. It has also indicated that many pilots have never been trained in maximum-performance airplane maneuvers, such as aerobatic maneuvers, and those pilots who have been exposed to aerobatics lose their skills over time.

Several operators have reacted to this situation by developing and implementing pilot training programs that include academic and simulator training. Some government regulatory agencies are encouraging airlines to provide education and training to better

prepare pilots to recover airplanes that have been upset. Airplane manufacturers have responded to this by leading an industry team formed to develop this *Airplane Upset Recovery Training Aid*.

The team approach to the development of training has several advantages. Most issues are identified and discussed, and a consensus is then achieved that is acceptable to the aviation industry. This process reduces the time for development and implementation of training. Synergy is gained during this process that results in an improved product. Finally, a training program is readily available to any operator that may not have been able to produce its own program. Established programs may be improved and modified.

This training aid is intended to be a comprehensive training package that airlines can present to their flight crews in a combination of classroom and simulator programs. It is structured to be a baseline tool to incorporate into existing programs or to customize by the operator to meet its unique requirements.

There will be additional costs associated with airplane upset recovery training; however, it is anticipated that the return on investment will be a reduction in airplane accidents. An operator will find the implementation of this training package to be principally a change in emphasis, not a replacement of existing syllabi. Some of the training may be conducted in conjunction with existing training requirements, which may reduce the additional costs. Except in unique instances where training devices may need upgrading to address significant preexisting limitations, there should be virtually no hardware costs associated with this upset recovery training.

Airplane upsets happen for a variety of reasons. Some are more easily prevented than others. Improvement in airplane design and equipment reliability continues to be a goal of airplane manufacturers and others. The industry has seen improvements to the point that airplane upsets happen so infrequently that pilots are not always prepared or trained to respond correctly. Airplane

1. Source: “*Statistical Summary of Commercial Jet Airplane Accidents, Worldwide Operations, 1998–2007*,” Airplane Safety Engineering, Boeing Commercial Airplane Group (Seattle, Washington, USA: July 2008).

upsets that are caused by environmental factors are difficult to predict; therefore, training programs stress avoidance of such phenomena, but this is not always successful. The logical conclusion is that pilots should be trained to safely recover an airplane that has been upset. For this training to be implemented, it needs to be supported by the top management within all airplane operators. Many operators are now conducting Airplane Upset Recovery Training. The unanimous consensus from operations and training managers indicates this training better prepares crews for these unintentional situations.

### 1.1 General Goal and Objectives

The goal of the *Airplane Upset Recovery Training Aid* is to increase the pilot's ability to recognize and avoid situations that can lead to airplane upsets and improve the pilot's ability to recover control of an airplane that has exceeded the normal flight regime. This can be accomplished by increasing awareness of potential upset situations and knowledge of flight dynamics and by the application of this knowledge during simulator training scenarios.

Objectives to support this goal include the following:

- a. Establishment of an industrywide consensus on a variety of effective training methods for pilots to recover from airplane upsets.
- b. Development of appropriate educational materials.
- c. Development of an example training program, providing a basis from which individual operators may develop tailored programs.

### 1.2 Documentation Overview

In addition to the Overview for Management, the *Airplane Upset Recovery Training Aid* package consists of the following:

- a. Section 2: "Pilot Guide to Airplane Upset Recovery."
- b. Section 3: "Example Airplane Upset Recovery Training Program."
- c. Section 4: "References for Additional Information."
- d. Video: Airplane Upset Recovery.

**Section 2.** The "Pilot Guide to Airplane Upset Recovery" briefly reviews the causes of airplane upsets; fundamental flight dynamics of flight for large, swept-wing airplanes; and the application

of flight dynamic fundamentals for recovering an airplane that has been upset. The guide is a highly readable, concise treatment of pilot issues, written by pilots—for pilots. It is intended for self-study or classroom use.

**Section 3.** The "Example Airplane Upset Recovery Training Program" is a stand-alone resource designed to serve the needs of a training department. An example academic training program and a simulator training program are both included. Academic training provides pilots with the foundation for avoiding airplane upsets that are within their control and also provides information about flight dynamics associated with airplane recovery. The flight simulator scenarios are designed to provide the opportunity for pilots to apply the knowledge gained in the academic program and improve their skills in recovery from airplane upset.

**Section 4.** This section consists of references for additional reading on subjects associated with airplane upsets and recovery.

**Video Program.** Airplane Upset Recovery is intended for use in an academic program in conjunction with the "Pilot Guide to Airplane Upset Recovery."

**CD-ROM.** Document and video.

### 1.3 Industry Participants

The following organizations participated in the development of this training aid:

ABX Air, Inc.  
 A.M. Carter Associates  
 (Institute for Simulation & Training)  
 Air Transport Association  
 Airbus  
 Air Line Pilots Association  
 AirTran Airways  
 Alaska Airlines, Inc.  
 All Nippon Airways Co., Ltd.  
 Allied Pilots Association  
 Aloha Airlines, Inc.  
 American Airlines, Inc.  
 American Trans Air, Inc.  
 Ansett Australia  
 Bombardier Aerospace Training Center  
 (Regional Jet Training Center)  
 British Airways



Calspan Corporation  
 Cathay Pacific Airways Limited  
 Cayman Airways, Ltd.  
 Civil Aviation House  
 Continental Airlines, Inc.  
 Delta Air Lines, Inc.  
 Deutsche Lufthansa AG  
 EVA Airways Corporation  
 Federal Aviation Administration  
 FlightSafety International  
 Flight Safety Foundation  
 Hawaii Airlines  
 International Air Transport Association  
 Japan Airlines Co., Ltd.  
 Lufthansa German Airlines  
 Midwest Express Airlines, Inc.  
 National Transportation Safety Board  
 Northwest Airlines, Inc.  
 Qantas Airways, Ltd.  
 SAS Flight Academy  
 Southwest Airlines  
 The Boeing Company  
 Trans World Airlines, Inc.  
 United Air Lines, Inc.  
 Upset Doomain Training Institute  
 US Airways, Inc.  
 Veridian

and efficient program.

The allocation of training time within recurrent and transition programs will vary from operator to operator.

## 1.5 Conclusion

This document and video are designed to assist operators in creating or updating airplane upset recovery training programs. While this training aid stresses the importance of avoiding airplane upsets, those upsets that are caused by the environment or airplane equipment failures can be difficult, if not impossible, for the pilot to avoid. Therefore, management is encouraged to take appropriate steps to ensure that an effective airplane upset recovery training program is in place for pilots. The reduction of loss-of-control accidents is a targeted meaningful improvement in aviation safety. Results can be gained by training in this area. In competition with other items demanding resources, such as security, safety should always be considered paramount to success.

Many meetings were held, during which consensus was gained among the participants concerning the goal and objectives for the training aid. Several review cycles were conducted, in which comments and recommendations were considered for inclusion in the final material.

## 1.4 Resource Utilization

This document has been designed to be of maximum utility, both in its current form and as a basis for an operator to design or modify an airplane upset program as it sees fit.

Both academic and practical simulator training should be employed to achieve a well-balanced, effective training program. For some operators, the adoption of the *Airplane Upset Recovery Training Aid* into their existing training programs may not entail much change. For those operators that are in the process of creating a complete training program, the *Airplane Upset Recovery Training Aid* will readily provide the foundation of a thorough





# Pilot Guide to Airplane Upset Recovery

## Table of Contents

# 2

Section	Page
2.0	Introduction ..... 2.1
2.1	Objectives ..... 2.1
2.2	Definition of Airplane Upset ..... 2.1
2.3	The Situation ..... 2.2
2.4	Causes of Airplane Upsets..... 2.2
2.4.1	Environmentally Induced Airplane Upsets ..... 2.3
2.4.1.1	Turbulence..... 2.3
2.4.1.1.1	Clear Air Turbulence..... 2.4
2.4.1.1.2	Mountain Wave..... 2.4
2.4.1.1.3	Windshear ..... 2.4
2.4.1.1.4	Thunderstorms ..... 2.4
2.4.1.1.5	Microbursts ..... 2.5
2.4.1.2	Wake Turbulence ..... 2.6
2.4.1.3	Airplane Icing..... 2.8
2.4.2	Systems-Anomalies-Induced Airplane Upsets ..... 2.8
2.4.2.1	Flight Instruments ..... 2.9
2.4.2.2	Autoflight Systems ..... 2.9
2.4.2.3	Flight Control and Other Anomalies ..... 2.9
2.4.3	Pilot-Induced Airplane Upsets..... 2.10
2.4.3.1	Instrument Cross-Check ..... 2.10
2.4.3.2	Adjusting Attitude and Power ..... 2.10
2.4.3.3	Inattention..... 2.10
2.4.3.4	Distraction From Primary Cockpit Duties..... 2.11
2.4.3.5	Vertigo or Spatial Disorientation..... 2.11
2.4.3.6	Pilot Incapacitation..... 2.11
2.4.3.7	Improper Use of Airplane Automation..... 2.11
2.4.3.8	Pilot Techniques—PIO Avoidance/Recovery..... 2.12
2.4.4	Combination of Causes..... 2.12
2.5	Swept-Wing Airplane Fundamentals for Pilots ..... 2.12
2.5.1	Flight Dynamics ..... 2.13
2.5.2	Energy States ..... 2.13
2.5.3	Load Factor..... 2.14
2.5.4	Aerodynamic Flight Envelope..... 2.17
2.5.5	Aerodynamics..... 2.18
2.5.5.1	Angle of Attack and Stall ..... 2.18
2.5.5.2	Camber ..... 2.21
2.5.5.3	Control Surface Fundamentals ..... 2.22
2.5.5.3.1	Spoiler-Type Devices..... 2.22
2.5.5.3.2	Trim ..... 2.23
2.5.5.4	Lateral and Directional Aerodynamic Considerations ..... 2.24
2.5.5.4.1	Angle of Sideslip ..... 2.24
2.5.5.4.2	Wing Dihedral Effects ..... 2.25
2.5.5.4.3	Pilot-Commanded Sideslip ..... 2.26

<b>Section</b>	<b>Page</b>
2.5.5.4.4 Crossover Speed .....	2.26
2.5.5.5 Stability .....	2.27
2.5.5.6 Maneuvering in Pitch .....	2.27
2.5.5.7 Mechanics of Turning Flight .....	2.29
2.5.5.8 Lateral Maneuvering .....	2.30
2.5.5.9 Directional Maneuvering.....	2.31
2.5.5.10 Flight at Extremely Low Airspeeds.....	2.34
2.5.5.11 High-Altitude Characteristics.....	2.34
2.5.5.11.1 Regulatory Issues.....	2.36
2.5.5.11.2 Aerodynamic Principles of High Altitude Operations.....	2.36
2.5.5.11.2.1 L/D Max .....	2.36
2.5.5.11.2.2 Crossover Altitude .....	2.37
2.5.5.11.2.3 Optimum Altitude.....	2.37
2.5.5.11.2.4 Optimum Climb Speed Deviations.....	2.37
2.5.5.11.2.5 Thrust Limited Condition and Recovery.....	2.37
2.5.5.11.2.6 Maximum Altitude.....	2.37
2.5.5.11.2.7 Maneuvering Stability .....	2.37
2.5.5.11.3 Weight & Balance Effects on Handling Characteristics.....	2.39
2.5.5.11.4 Mach Tuck and Mach Buffet .....	2.39
2.5.5.11.5 Buffet-Limited Maximum Altitude.....	2.39
2.5.5.11.6 Stalls .....	2.40
2.5.5.11.7 Icing .....	2.40
2.5.5.11.8 Primary Flight Display Airspeed Indications .....	2.41
2.5.5.11.9 Automation During High Altitude Flight .....	2.41
2.5.5.11.10 Human Factors and High Altitude Upsets .....	2.42
2.5.5.11.11 Additional Considerations .....	2.42
2.5.5.11.11.1 Multi-Engine Flame Out.....	2.42
2.5.5.11.11.2 Core Lock.....	2.43
2.5.5.11.11.3 Rollback.....	2.43
2.5.5.12 Flight at Extremely High Speeds.....	2.43
2.5.5.13 Defensive, Aggressive Maneuvers .....	2.44
2.6 Recovery From Airplane Upsets .....	2.44
2.6.1 Situation Awareness of an Airplane Upset .....	2.44
2.6.2 Miscellaneous Issues Associated With Upset Recovery.....	2.45
2.6.2.1 Startle Factor .....	2.45
2.6.2.2 Negative G Force.....	2.45
2.6.2.3 Use of Full Control Inputs.....	2.46
2.6.2.4 Counter-Intuitive Factors .....	2.46
2.6.2.5 Previous Training in Nonsimilar Airplanes .....	2.46
2.6.2.6 Potential Effects on Engines.....	2.46
2.6.2.7 Post Upset Conditions .....	2.46
2.6.3 Airplane Upset Recovery Techniques .....	2.46
2.6.3.1 Stall.....	2.47
2.6.3.2 Nose-High, Wings-Level Recovery Techniques .....	2.47
2.6.3.3 Nose-Low, Wings-Level Recovery Techniques .....	2.48
2.6.3.4 High-Bank-Angle Recovery Techniques.....	2.49
2.6.3.5 Consolidated Summary of Airplane Recovery Techniques.....	2.49

# Pilot Guide to Airplane Upset Recovery

# 2

## 2.0 Introduction

The “Pilot Guide to Airplane Upset Recovery” is one part of the *Airplane Upset Recovery Training Aid*. The other parts include an “Overview for Management” (Sec. 1), “Example Airplane Upset Recovery Training Program” (Sec. 3), “References for Additional Information” (Sec. 4), and a two-part video.

The goal of this training aid is to increase the ability of pilots to *recognize and avoid* situations that can lead to airplane upsets and to improve their ability to recover control of an airplane that has exceeded the normal flight regime. This will be accomplished by increasing awareness of potential upset situations and knowledge of aerodynamics and by application of this knowledge during simulator training scenarios.

The education material and the recommendations provided in the *Airplane Upset Recovery Training Aid* were developed through an extensive review process by a large industry group in order to achieve a consensus of the air transport industry.

Because of the infinite variables that comprise upset situations, the industry group unanimously agrees that airplane upset recovery education must not include simulator testing criteria. By definition, testing implies procedure demonstration and objective assessment of performance. The goal of upset recovery is to regain aircraft flight path control. A testing environment could lead to similar negative learning conclusions that can currently exist with approach to stall performance when measured against minimum loss of altitude.

## 2.1 Objectives

The objectives of the “Pilot Guide to Airplane Upset Recovery” are to provide pilots with

- Knowledge to recognize situations that may lead to airplane upsets so that they may be prevented.
- Basic airplane aerodynamic information.
- Airplane flight maneuvering information and techniques for recovering airplanes that have been upset.

It is intended that this information be provided to pilots during academic training and that it be retained for future use.

## 2.2 Definition of Airplane Upset

Research and discussions within the commercial aviation industry indicated that it was necessary to establish a descriptive term and definition in order to develop this training aid. Terms such as “unusual attitude,” “advanced maneuver,” “selected event,” “loss of control,” “airplane upset,” and others are terms used within the industry. The team decided that “airplane upset” was appropriate for this training aid. It is important to be clear on two factors. First is the notion of *unintentional*. In other words, the aircraft is not doing what it was being commanded to do and is approaching unsafe parameters. Second is the fact that a pilot must not wait until the airplane is in a fully developed and definable upset before taking corrective action to return to stabilized flight path parameters. Therefore, in order to identify acceptable references that define a developed upset condition, the following values were agreed upon. An airplane upset is defined as an airplane in flight unintentionally exceeding the parameters normally experienced in line operations or training. In other words, the airplane is not doing what it was commanded to do and is approaching unsafe parameters.

While specific values may vary among airplane models, the following unintentional conditions generally describe an airplane upset:

- Pitch attitude greater than 25 deg, nose up.
- Pitch attitude greater than 10 deg, nose down.
- Bank angle greater than 45 deg.
- Within the above parameters, but flying at airspeeds inappropriate for the conditions.

**It should be emphasized that recovery to a stabilized flight path *should* be initiated as soon as a developing upset condition is recognized.** The amount and rate of control input to counter a developing upset must be *proportional* to the *amount and rate of pitch, roll and/or yaw experienced*. This preventive action may alleviate what might have become a more serious event.

### 2.3 The Situation

The commercial aviation industry has not specifically tracked airplane upset incidents that meet this training aid's precise definition; therefore, safety data do not directly correlate to the upset parameters established for this training aid. However, the data that are available suggest that loss of control is a problem that deserves attention. Figure 1 shows that loss of control in flight accounted for many fatalities during the indicated time period.

### 2.4 Causes of Airplane Upsets

Airplane upsets are not a common occurrence. This may be for a variety of reasons. Airplane design and certification methods have improved. Equipment has become more reliable. Perhaps training programs have been effective in teaching pilots to avoid situations that lead to airplane upsets. While airplane upsets seldom take place, there are a variety of reasons why they happen. Figure 2 shows incidents and causes from NASA Aviation Safety Reporting System (ASRS) reports. The National Transportation Safety Board analysis of 20 transport-category loss-of-control accidents from 1986 to 1996 indicates that the majority were caused by the airplane stalling (Fig. 3). This section provides a review of the most prevalent causes for airplane upsets.

*Figure 1  
Worldwide Commercial  
Jet Fleet Fatalities  
Classified by  
Type of Event,  
1994 to 2003*

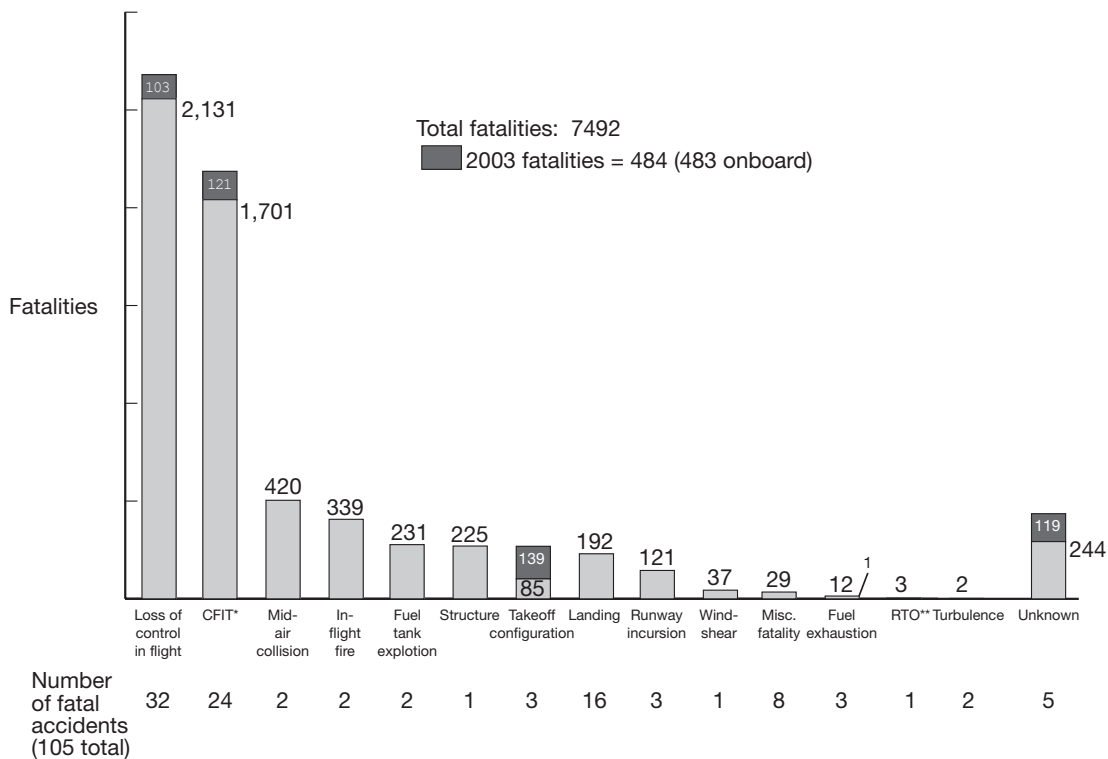

\* CFIT = Controlled Flight Into Terrain  
 \*\* RTO = Refused Takeoff

Note: Accidents involving multiple, non-onboard fatalities are included. Accidents involving single, non-onboard fatalities are excluded. Fatalities/accidents are placed in one category only.

## 2.4.1 Environmentally Induced Airplane Upsets

The predominant number of airplane upsets are caused by various environmental factors (Fig. 2). Unfortunately, the aviation industry has the least amount of influence over the environment when compared to human factors or airplane-anomaly-caused upsets. The industry recognizes this dilemma and resorts to training as a means for avoiding environmental hazards. Separate education and training aids have been produced through an industry team process that addresses turbulence, windshear, and wake turbulence.

Avoidance of environmentally induced upsets is the best course of action. Pilots should monitor the environmental conditions and avoid high risk situations.

### 2.4.1.1 Turbulence

*“Turbulence, when extreme, can lead to airplane upsets, and/or structural damage. These incidents of turbulence can cause large airspeed, altitude, or attitude deviations. The aircraft may be momentarily out of control. Severe or extreme turbulence can be associated with CAT (Clear Air Turbulence), mountain waves, windshear, thunderstorms, and wake turbulence.”<sup>2</sup>*

Turbulent atmosphere is characterized by a large variation in an air current over a short distance. The main causes of turbulence are jet streams, convective currents, obstructions to wind flow, and windshear. Turbulence is categorized as “light,” “moderate,” “severe,” and “extreme.” Refer to an industry-produced *Turbulence Education and Training Aid* for more information about

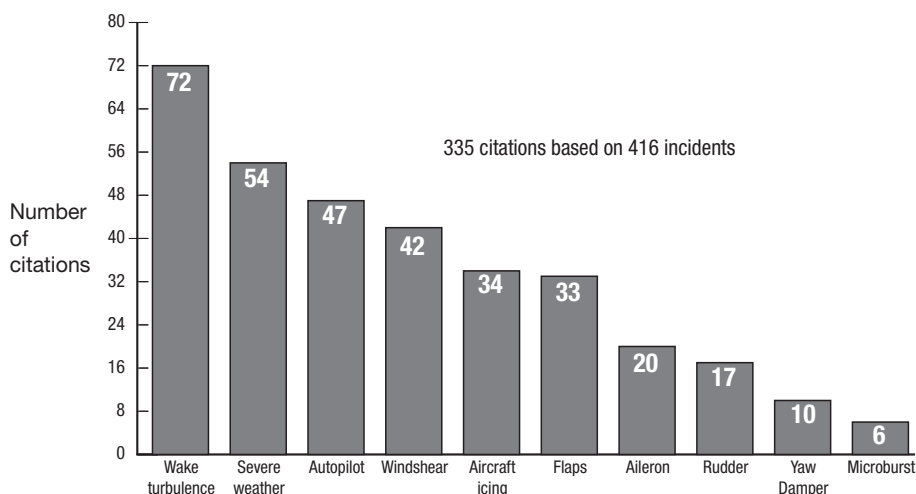

Figure 2  
Multiengine Turbojet Loss-of-Control Incidents, January 1996 to August 2002, ASRS

- Data references ASRS reports that have received full-form analysis and include the reporters' narrative.
- Categories are not mutually exclusive; therefore, a single incident may be coded by ASRS analysts as involving more than one citation. As an example, a pilot may experience severe weather, wake turbulence, and icing in the same incident.
- Data are based on inflight loss of aircraft control reports containing any reference to those categories in the reporters' narratives.

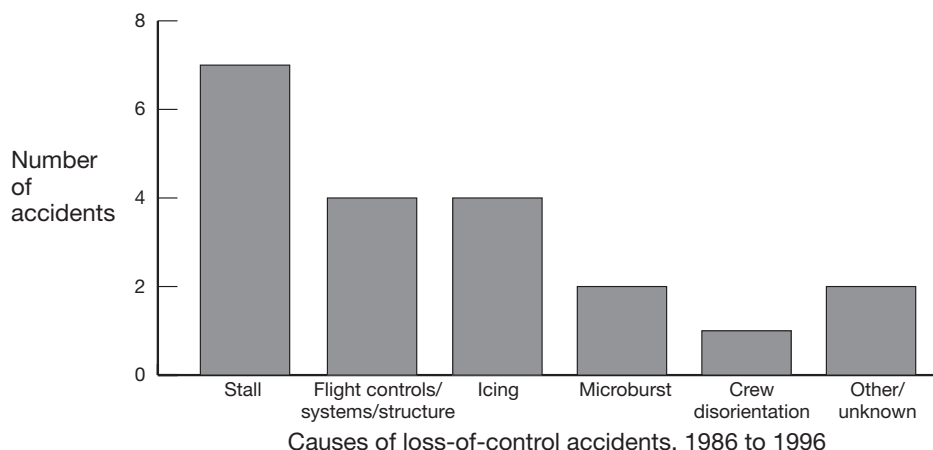

Figure 3  
Loss-of-Control Accidents (Transport Category)

2. Source: *Turbulence Education and Training Aid*, U.S. Department of Transportation, Federal Aviation Administration, Air Transport Association of America, The Boeing Company, National Technical Information Services (Seattle, Washington, USA: May 1997).



turbulence. This aid is available from the National Technical Information Service or The Boeing Company. Only limited information is presented in this section for a short review of the subject. Knowledge of the various types of turbulence assists in avoiding it and, therefore, the potential for an airplane upset.

In one extreme incident, an airplane encountered severe turbulence that caused the number 2 engine to depart the airplane. The airplane entered a roll 50 deg left, followed by a huge yaw. Several pitch and roll oscillations were reported. The crew recovered and landed the airplane.

#### 2.4.1.1.1 Clear Air Turbulence

Clear air turbulence (CAT) is defined by the Aeronautical Information Manual as “high-level turbulence (normally above 15,000 ft above sea level) not associated with cumuliform cloudiness, including thunderstorms.”

Although CAT can be encountered in any layer of the atmosphere, it is almost always present in the vicinity of jet streams. A number of jet streams (high-altitude paths of winds exceeding velocities of 75 to 100 kn) may exist at any given time, and their locations will vary constantly. CAT becomes particularly difficult to predict as it is extremely dynamic and does not have common dimensions of area or time. In general, areas of turbulence associated with a jet stream are from 100 to 300 mi long, elongated in the direction of the wind; 50 to 100 mi wide; and 2000 to 5000 ft deep. These areas may persist from 30 min to 1 day. CAT near the jet stream is the result of the difference in wind speeds and the windshear generated between points. CAT is considered moderate when the vertical windshear is 5 kn per 1000 ft or greater and the horizontal shear is 20 kn per 150 nm, or both. Severe CAT occurs when the vertical shear is 6 kn per 1000 ft and the horizontal shear is 40 kn per 150 nm or greater, or both.

#### 2.4.1.1.2 Mountain Wave

Mountains are the greatest obstructions to wind flow. This type of turbulence is classified as “mechanical” because it is caused by a mechanical disruption of wind. Over mountains, rotor or lenticular clouds are sure signs of turbulence. However, mechanical turbulence may also be present in air too dry to produce clouds. Light to extreme turbulence is created by mountains.

Severe turbulence is defined as that which causes large, abrupt changes in altitude or attitude. It usually causes large variation in indicated airspeed. The airplane may be momentarily out of control. Severe turbulence can be expected in mountainous areas where wind components exceeding 50 kn are perpendicular to and near the ridge level; in and near developing and mature thunderstorms; occasionally, in other towering cumuliform clouds; within 50 to 100 mi on the cold side of the center of the jet stream; in troughs aloft; and in lows aloft where vertical windshears exceed 10 kn per 1000 ft and horizontal windshears exceed 40 kn per 150 nm.

Extreme turbulence is defined as that in which the airplane is violently tossed around and practically impossible to control. It may cause structural damage. Extreme turbulence can be found in mountain-wave situations, in and below the level of well-developed rotor clouds, and in severe thunderstorms.

#### 2.4.1.1.3 Windshear

Wind variations at low altitude have long been recognized as a serious hazard to airplanes during takeoff and approach. These wind variations can result from a large variety of meteorological conditions, such as topographical conditions, temperature inversions, sea breezes, frontal systems, strong surface winds, and the most violent forms of wind change—thunderstorms and rain showers. Thunderstorms and rain showers may produce an airplane upset, and they will be discussed in the following section. The *Windshear Training Aid* provides comprehensive information on windshear avoidance and training. This aid is available from the National Technical Information Service or The Boeing Company.

#### 2.4.1.1.4 Thunderstorms

There are two basic types of thunderstorms: airmass and frontal. Airmass thunderstorms appear to be randomly distributed in unstable air, and they develop from localized heating at the Earth’s surface (Fig. 4). The heated air rises and cools to form cumulus clouds. As the cumulus stage continues to develop, precipitation forms in high portions of the cloud and falls. Precipitation signals the beginning of the mature stage and the presence of a downdraft. After approximately an hour, the heated updraft creating the thunderstorm is cut off by rainfall. Heat is removed and the thunderstorm dissipates. Many thunderstorms produce an associated cold-air gust

front as a result of the downflow and outrush of rain-cooled air. These gust fronts are usually very turbulent, and they can create a serious airplane upset, especially during takeoff and approach.

Frontal thunderstorms are usually associated with weather systems line fronts, converging wind, and troughs aloft (Fig. 5). Frontal thunderstorms form in squall lines; last several hours; generate heavy rain, and possibly hail; and produce strong gusty winds, and possibly tornadoes. The principal distinction in formation of these more severe thunderstorms is the presence of large, horizontal wind changes (speed and direction) at different altitudes in the thunderstorm. This causes the severe thunderstorm to be vertically tilted. Precipitation falls away from

the heated updraft, permitting a much longer storm development period. Resulting airflows within the storm accelerate to much higher vertical velocities, which ultimately results in higher horizontal wind velocities at the surface. The downward moving column of air, or downdraft, of a typical thunderstorm is fairly large, about 1 to 5 mi in diameter. Resultant outflows may produce large changes in windspeed.

#### 2.4.1.1.5 Microbursts

Identification of concentrated, more powerful downdrafts—known as microbursts—has resulted from the investigation of windshear accidents and from meteorological research. Microbursts can oc-

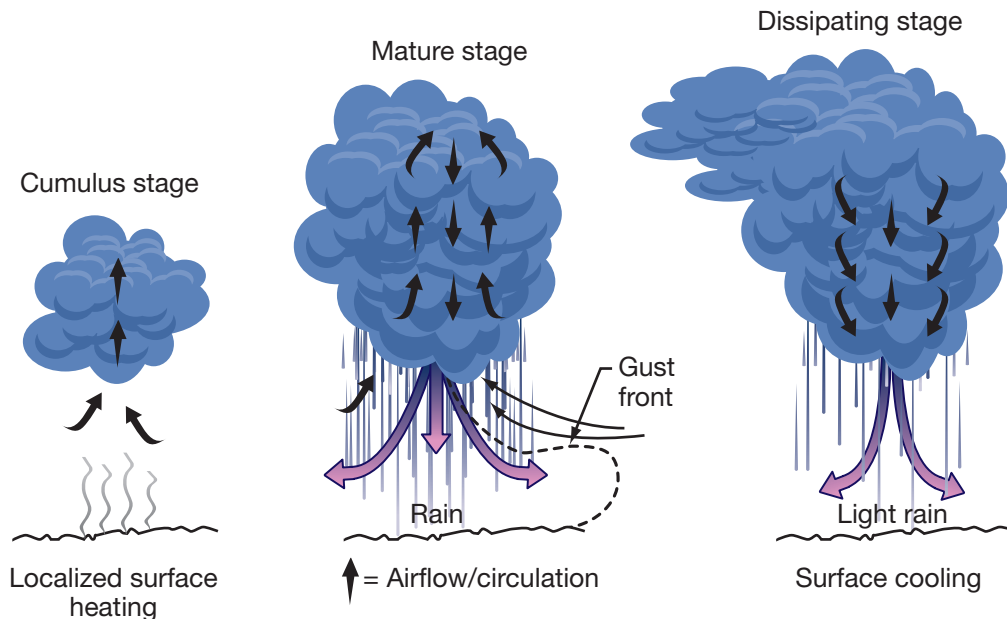

Figure 4  
Airmass  
Thunderstorm  
Life Cycle

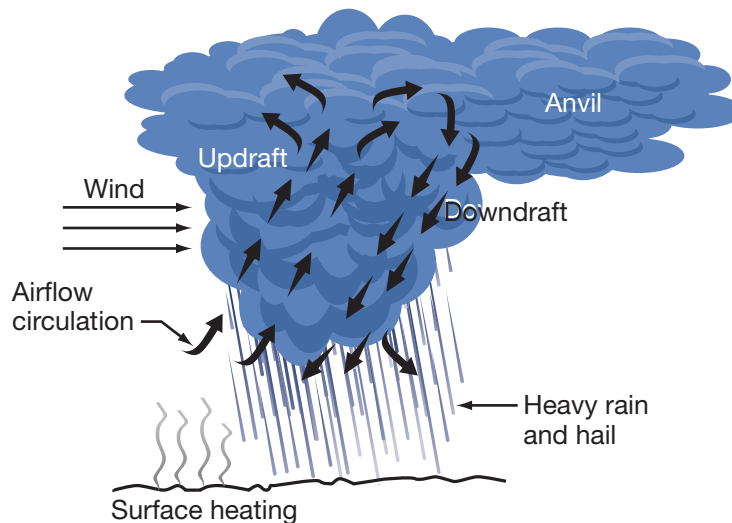

Figure 5  
Severe Frontal  
Thunderstorm  
Anatomy

cur anywhere convective weather conditions occur. Observations suggest that approximately 5% of all thunderstorms produce a microburst. Downdrafts associated with microbursts are typically only a few hundred to 3000 ft across. When a downdraft reaches the ground, it spreads out horizontally and may form one or more horizontal vortex rings around the downdraft (Fig. 6). Microburst outflows are not always symmetric. Therefore, a significant airspeed increase may not occur upon entering outflows, or it may be much less than the subsequent airspeed loss experienced when exiting the microburst. Windspeeds intensify for about 5 min after a microburst initially contacts the ground and typically dissipate within 10 to 20 min after ground contact.

*It is vital to recognize that some microbursts cannot be successfully escaped with any known techniques.*

#### 2.4.1.2 Wake Turbulence

Wake turbulence is the leading cause of airplane upsets that are induced by the environment. However, a wake turbulence penetration does not necessarily mean an airplane will become upset. The phenomenon that creates wake turbulence results from the forces that lift the airplane. High-pressure air from the lower surface of the wings flows around the wingtips to the lower pressure region above the wings. A pair of counterrotating vortices are thus shed from the wings: the right

*Figure 6  
Symmetric  
Microburst—An  
airplane transiting  
the microburst  
would experience  
equal headwinds  
and tailwinds.*

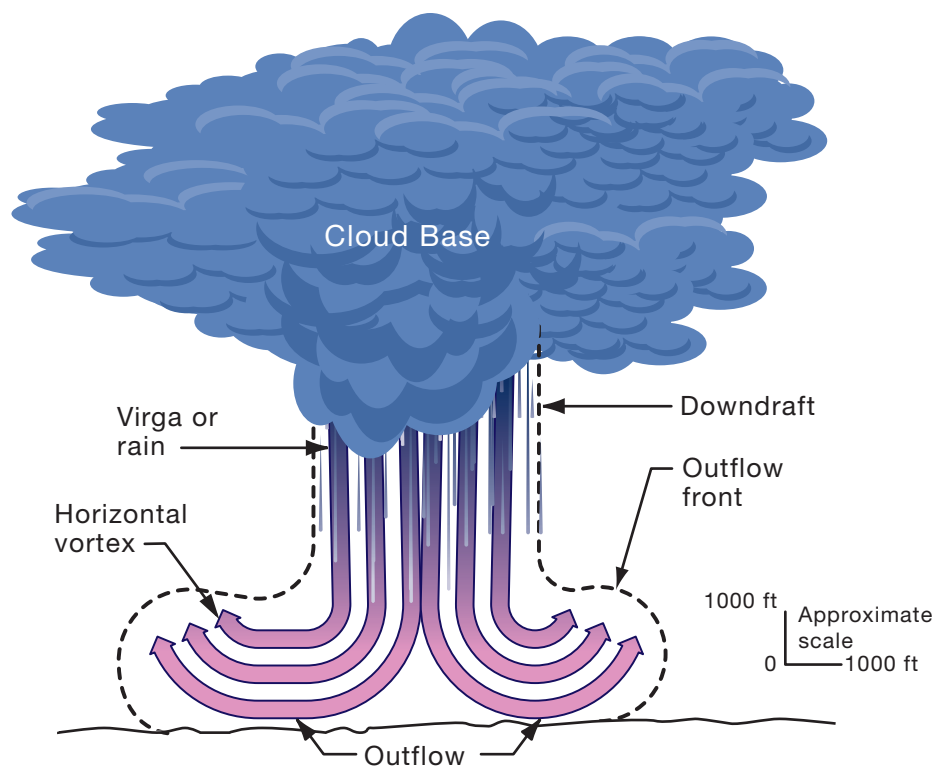

wing vortex rotates counterclockwise, and the left wing vortex rotates clockwise (Fig. 7). The region of rotating air behind the airplane is where wake turbulence occurs. The strength of the turbulence is determined predominantly by the weight, wingspan, and speed of the airplane. Generally, vortices descend at an initial rate of about 300 to 500 ft/min for about 30 sec. The descent rate decreases and eventually approaches zero at between 500 and 900 ft below the flight path. Flying at or above the flight path provides the best method for avoidance. Maintaining a vertical separation of at least 1000 ft when crossing below the preceding aircraft may be considered safe. This vertical motion is illustrated in Figure 8. Refer to the *Wake Turbulence Training Aid* for comprehensive information on how to avoid wake turbulence. This aid is available from the National Technical Information Service or The Boeing Company.

An encounter with wake turbulence usually results in induced rolling or pitch moments; however, in rare instances an encounter could cause structural damage to the airplane. In more than one instance, pilots have described an encounter to be like “hitting a wall.” The dynamic forces of the vortex can exceed the roll or pitch capability of the airplane to overcome these forces. During test programs, the wake was approached from all directions to evaluate the effect of encounter direction on response. One item was common to all encounters: with little to no control input from the pilot, the airplane would be expelled from the wake and an airplane upset could result.

Opposing the roll moment using normal roll control (aileron and roll spoiler) is usually effective and induced roll is minimal in cases where the wingspan and ailerons of the encountering airplane extend

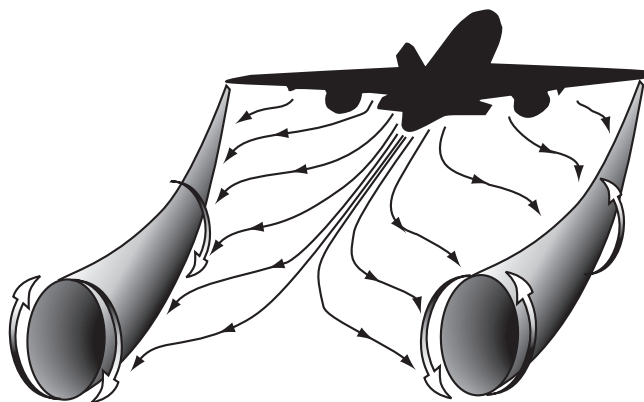

Figure 7  
Wake Turbulence  
Formation

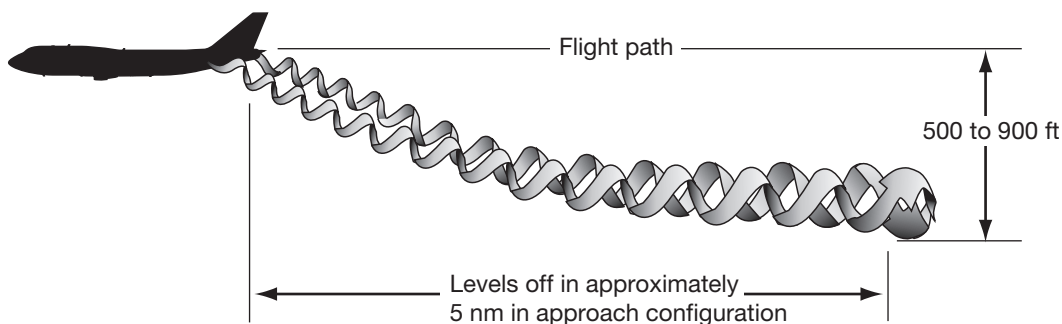

Figure 8  
Vertical Motion Out  
of Ground Effect

beyond the rotational flowfield of the vortex (Fig. 9). It is more difficult for airplanes with short wingspan (relative to the generating airplane) to counter the imposed roll induced by the vortex flow.

Avoiding wake turbulence is the key to avoiding many airplane upsets. Pilot and air traffic control procedures and standards are designed to accomplish this goal, but as the aviation industry expands, the probability of an encounter also increases.

### 2.4.1.3 Airplane Icing

Technical literature is rich with data showing the adverse aerodynamic effects of airfoil contamination. Large degradation of airplane performance can result from the surface roughness of an extremely small amount of contamination. These detrimental effects vary with the location and roughness, and they produce unexpected airplane handling characteristics, including degradation of maximum lift capability, increased drag, and possibly unanticipated changes in stability and control. Therefore, the axiom of “keep it clean” for critical airplane surfaces continues to be a universal requirement.

### 2.4.2 Systems-Anomalies-Induced Airplane Upsets

Airplane designs, equipment reliability, and flight crew training have all improved since the Wright brothers’ first powered flight. Airplane certification processes and oversight are rigorous. Airlines and manufacturers closely monitor equipment failure rates for possible redesign of airplane parts or modification of maintenance procedures. Dissemination of information is rapid if problems are detected. Improvement in airplane designs and equipment components has always been a major focus in the aviation industry. In spite of this continuing effort, there are still failures. Some of these failures can lead to an airplane upset. That is why flight crews are trained to overcome or mitigate the impact of the failures. Most failures are survivable if correct responses are made by the flight crew.

An airplane was approaching an airfield and appeared to break off to the right for a left downwind to the opposite runway. On downwind at approximately 1500 ft, the airplane pitched up to nearly 60 deg and climbed to an altitude of nearly 4500 ft, with the airspeed deteriorating to almost

Figure 9  
Induced Roll

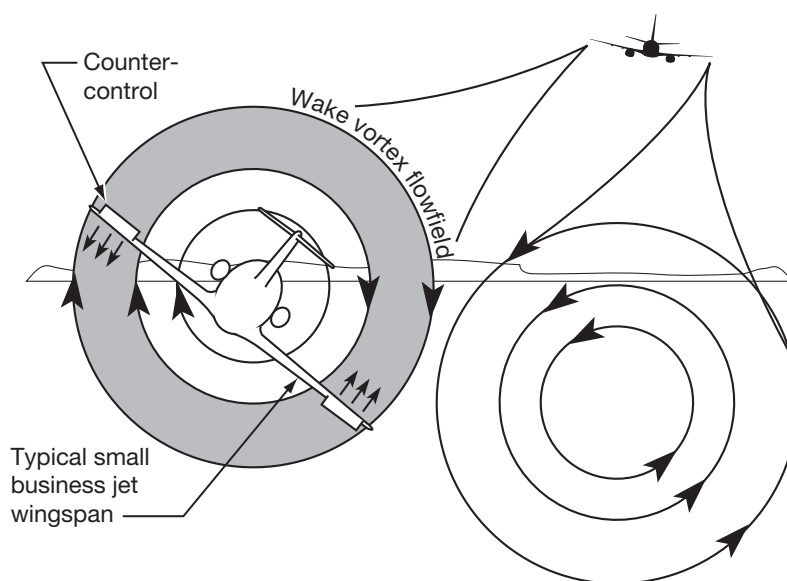

0 kn. The airplane then tail-slid, pitched down, and seemingly recovered. However, it continued into another steep pitchup of 70 deg. This time as it tail-slid, it fell off toward the right wing. As it pitched down and descended again, seemingly recovering, the airplane impacted the ground in a flat pitch, slightly right wing down. The digital flight data recorder indicated that the stabilizer trim was more than 13 units nose up. The flight crew had discussed a trim problem during the descent but made no move to cut out the electric trim or to manually trim. The accident was survivable if the pilot had responded properly.

#### 2.4.2.1 Flight Instruments

The importance of reliable flight instruments has been known from the time that pilots first began to rely on artificial horizons. This resulted in continual improvements in reliability, design, redundancy, and information provided to the pilots.

However, instrument failures do infrequently occur. All airplane operations manuals provide flight instrument system information so that when failures do happen, the pilot can analyze the impact and select the correct procedural alternatives. Airplanes are designed to make sure pilots have at least the minimum information needed to safely control the airplane.

In spite of this, several accidents point out that pilots are not always prepared to correctly analyze the alternatives, and an upset takes place. During the takeoff roll, a check of the airspeed at 80 kn revealed that the captain's airspeed was not functioning. The takeoff was continued. When the airplane reached 4700 ft, about 2 min into the flight, some advisory messages appeared informing the crew of flight control irregularities. Comments followed between the pilots about confusion that was occurring between the airspeed indication systems from the left-side airspeed indication system, affecting the indication of the left-side airspeed autopilot and activation of the overspeed warning. The airplane continued flying with the autopilot connected and receiving an erroneous indication in the captain's airspeed. Recorded sounds and flight data indicated extreme conditions of flight, one corresponding to overspeed and the other to slow speed (stick shaker). The captain initiated an action to correct the overspeed, and the copilot advised that his airspeed indicator was decreasing. The airplane had three airspeed indicating systems, and at no time

did the flight crew mention a comparison among the three systems. The flight recorders indicated the airplane was out of control for almost 2 min until impact. Experts determined that the anomalies corresponded to conditions equal to an obstruction in the captain's airspeed sensors (pitot head).

#### 2.4.2.2 Autoflight Systems

Autoflight systems include the autopilot, auto-throttles, and all related systems that perform flight management and guidance. The systems integrate information from a variety of other airplane systems. They keep track of altitude, heading, airspeed, and flight path with unflagging accuracy. The pilot community has tended to develop a great deal of confidence in the systems, and that has led to complacency in some cases. As reliable as the autoflight systems may be, they can, and have, malfunctioned. Because of the integration of systems, it may even be difficult for the pilot to analyze the cause of the anomaly, and airplane upsets have occurred. Since advanced automation may tend to mask the cause of the anomaly, an important action in taking control of the airplane is to reduce the level of automation. Disengaging the autopilot, the autothrottles, or both, may help in analyzing the cause of the anomaly by putting the pilot in closer touch with the airplane and perhaps the anomaly.

#### 2.4.2.3 Flight Control and Other Anomalies

Flight control anomalies, such as flap asymmetry, spoiler problems, and others, are addressed in airplane operations manuals. While they are rare events, airplane certification requirements ensure that pilots have sufficient information and are trained to handle these events. However, pilots should be prepared for the unexpected, especially during takeoffs. Engine failure at low altitudes while the airplane is at a low-energy condition is still a demanding maneuver for the pilot to handle. An erroneous stall warning on takeoff or shortly after takeoff could be a situation that allows the airplane to become upset.

A stall warning during takeoff could be the result of an incorrect V speed, incorrect flap or stabilizer position, a malfunctioning stall warning system, or a shift in cg during rotation. If an aircraft rotates at the wrong speed or in the wrong configuration, or when a malfunctioning stall warning system activates, care must be taken to adjust the flight profile so that airspeed and altitude will increase.

Remember that if the airplane flies too slow, induced drag will increase and it may be necessary to reduce the pitch attitude in order to accelerate. If a shift of cargo occurs, it may be helpful to leave the flaps and slats extended until approaching the limit speeds, where the horizontal tail has more pitch authority. For more information on the subject, refer to Section 2.6.3.2, “Nose-High, Wings-Level Recovery Techniques.”

### 2.4.3 Pilot-Induced Airplane Upsets

We have known for many years that sensory inputs can be misleading to pilots, especially when they cannot see the horizon. To solve this problem, airplanes are equipped with flight instruments to provide the necessary information for controlling the airplane.

#### 2.4.3.1 Instrument Cross-Check

Pilots must cross-check and interpret the instruments and apply the proper pitch, bank, and power adjustments. Misinterpretation of the instruments or slow cross-checks by the pilot can lead to an airplane upset.

An important factor influencing cross-check technique is the ability of the pilot: “All pilots do not interpret instrument presentations with the same speed; some are faster than others in understanding and evaluating what they see. One reason for this is that the natural ability of pilots varies. Another reason is that the experience levels are different. Pilots who are experienced and fly regularly will probably interpret their instruments more quickly than inexperienced pilots.”<sup>3</sup>

Because situations change rapidly during high workload periods, it is crucial for both pilots to monitor the flight path and instruments. In a low workload environment, one pilot can usually monitor the aircraft as there is normally little change. Since it is difficult to stay focused on monitoring during low workload periods, it may be beneficial for pilots to alternate this responsibility. The important thing to remember is that at least one pilot must monitor the aircraft at all times. Effective monitoring allows a pilot to take control of the aircraft before an upset occurs. Some airlines refer to the pilot not flying as the “pilot monitoring” to add emphasis to the importance of this role.

#### 2.4.3.2 Adjusting Attitude and Power

A satisfactory instrument cross-check is only one part of the equation. It is necessary for the pilot to make the correct adjustments to pitch, bank, and power in order to control the airplane. Airplane upsets have occurred when the pilot has made incorrect adjustments. This can happen when the pilot is not familiar with the airplane responses to power adjustments or control inputs. A pilot’s control inputs are usually based upon understanding of what the outcome will be. This is called airmanship. On the other hand, if the pilot’s control inputs are reactionary, unplanned, and excessive, the airplane reaction may be a complete surprise. A continued divergence from what is expected due to excessive control inputs can lead to an upset. There have also been instances when two pilots have applied opposing inputs simultaneously.

#### 2.4.3.3 Inattention

A review of airplane upsets shows that inattention or neglecting to monitor the airplane performance can result in minor excursions from normal flight regimes to extreme deviations from the norm. Many of the minor upsets can be traced to an improper instrument cross-check; for example, neglecting to monitor all the instruments or fixating on certain instrument indications and not detecting changes in others. Some instrument indications are not as noticeable as others. For example, a slight heading change is not as eye-catching as a 1000-ft/min change in vertical velocity indication.

There are many extreme cases of inattention by the flight crew that have resulted in airplane upset accidents. In one accident, a crew had discussed a recurring autothrottle problem but continued to use the autothrottle. On level-off from a descent, one throttle remained at idle and the other compensated by going to a high power setting. The resulting asymmetric thrust exceeded the autopilot authority and the airplane began to roll. At approximately 50 deg of bank, full pro-roll lateral control wheel was applied. The airplane rolled 168 deg into a steep dive of 78 deg, nose low, and crashed.

3. Source: *Instrument Flight Procedures*. Air Force Manual 11-217, Vol. 1 (1 April 1996).

#### 2.4.3.4 Distraction From Primary Cockpit Duties

“Control the airplane first” has always been a guiding principle in flying. Unfortunately, it is not always followed. In this incident, both pilots were fully qualified as pilot-in-command and were supervising personnel. The captain left the left seat, and the copilot set the airplane on autopilot and went to work on a clipboard on his lap. At this point the autopilot disengaged, possibly with no annunciator light warning. The airplane entered a steep, nosedown, right spiral. The copilot’s instrument panel went blank, and he attempted to use the pilot’s artificial horizon. However, it had tumbled. In the meantime, the captain returned to his station and recovered the airplane at 6000 ft using needle and ball. This is just one of many incidents where pilots have become distracted. Many times, the distraction is caused by relatively minor reasons, such as caution lights or engine performance anomalies.

#### 2.4.3.5 Vertigo or Spatial Disorientation

Spatial disorientation has been a significant factor in many airplane upset accidents. The definition of spatial disorientation is the inability to correctly orient oneself with respect to the Earth’s surface. A flight crew was climbing to about 2000 ft at night during a missed approach from a second instrument landing system (ILS) approach. The weather was instrument meteorological conditions (IMC)—ceiling: 400 ft, visibility: 2 mi, rain, and fog. The airplane entered a spiral to the left. The captain turned the controls over to the first officer, who was unsuccessful in the recovery attempt. The airplane hit trees and was destroyed by ground impact and fire. [NTSB/AAR-92-05]

All pilots are susceptible to sensory illusions while flying at night or in certain weather conditions. These illusions can lead to a conflict between actual attitude indications and what the pilot “feels” is the correct attitude. Disoriented pilots may not always be aware of their orientation error. Many airplane upsets occur while the pilot is busily engaged in some task that takes attention away from the flight instruments. Others perceive a conflict between bodily senses and the flight instruments but allow the airplane to become upset because they cannot resolve the conflict. Unrecognized spatial disorientation tends to occur during task-intensive portions of the flight, while recognized spatial disorientation occurs during attitude-changing maneuvers.

There are several situations that may lead to visual illusions and then airplane upsets. A pilot can experience false vertical and horizontal cues. Flying over sloping cloud decks or land that slopes gradually upward into mountainous terrain often compels pilots to fly with their wings parallel to the slope, rather than straight and level. A related phenomenon is the disorientation caused by the aurora borealis in which false vertical and horizontal cues generated by the aurora result in attitude confusion.

It is beyond the scope of this training aid to expand on the physiological causes of spatial disorientation, other than to alert pilots that it can result in loss of control of an airplane. It should be emphasized that the key to success in instrument flying is an efficient instrument cross-check. The only reliable aircraft attitude information, at night or in IMC, is provided by the flight instruments. Any situation or factor that interferes with this flow of information, directly or indirectly, increases the potential for disorientation. The pilot’s role in preventing airplane upsets due to spatial disorientation essentially involves three things: training, good flight planning, and knowledge of procedures. Both pilots must be aware that it can happen, and they must be prepared to control the airplane if the other person is disoriented.

#### 2.4.3.6 Pilot Incapacitation

A first officer fainted while at the controls en route to the Azores, Portugal. He slumped against the controls, and while the rest of the flight crew was removing him from his flight position, the airplane pitched up and rolled to over 80 deg of bank. The airplane was then recovered by the captain. While this is a very rare occurrence, it does happen, and pilots need to be prepared to react properly. Another rare possibility for airplane upset is an attempted hijack situation. Pilots may have very little control in this critical situation, but they must be prepared to recover the airplane if it enters into an upset.

#### 2.4.3.7 Improper Use of Airplane Automation

The following incident describes a classic case of improper use of airplane automation. “During an approach with autopilot 1 in command mode, a missed approach was initiated at 1500 ft. It is undetermined whether this was initiated by the pilots; however, the pilot attempted to counteract the autopilot-commanded pitchup by pushing forward



on the control column. Normally, pushing on the control column would disengage the autopilot, but automatic disconnect was inhibited in go-around mode in this model airplane. As a result of the control column inputs, the autopilot trimmed the stabilizer to 12 deg, nose up, in order to maintain the programmed go-around profile. Meanwhile, the pilot-applied control column forces caused the elevator to deflect 14 deg, nose down. The inappropriate pilot-applied control column forces resulted in three extreme pitchup stalls before control could be regained. The airplane systems operated in accordance with design specifications.” [FSF, Flight Safety Digest 1/92]

The advancement of technology in today’s modern airplanes has brought us flight directors, autopilots, autothrottles, and flight management systems. All of these devices are designed to reduce the flight crew workload. When used properly, this technology has made significant contributions to flight safety. But technology can include complexity and lead to trust and eventual complacency. The systems can sometimes do things that the flight crew did not intend for them to do. Industry experts and regulators continue to work together to find the optimal blend of hardware, software, and pilot training to ensure the highest possible level of system performance—which centers on the human element.

#### 2.4.3.8 Pilot Techniques—PIO Avoidance/Recovery

All aircraft are developed and certified so as to ensure that their control is easy and well-behaved throughout their operating envelope. Testing to ensure these good handling characteristics assumes that pilots are utilizing typical piloting techniques during routine line operations. In some circumstances, however, a pilot may find that his own control inputs can cause unwanted aircraft motion that could lead to an upset or loss of control. Known as pilot-induced oscillations (PIO), this condition occurs when a pilot’s commands become out of phase with the aircraft’s motion.

There could be a number of technical or human factors causes for this condition. Examples may include, an over-speed, an out-of-trim condition, or some flight control system failures. To the pilot, all of the causes result in the aircraft not responding as quickly or as aggressively as the pilot desires. This leads to pilot inputs that grow increasingly out of phase with the aircraft response. Pilots are most

susceptible to PIO when they put in rapid inputs under stress, such as during upset recoveries. The net effect is that pilot inputs may produce unpredictable aircraft motion with accompanied pitch or roll oscillations. Sometimes, the pilot flying may be so involved in regaining control, he may not be aware of this oscillatory motion. In this case, the pilot not flying may need to verbalize the PIO condition. In any case, the oscillations/coupling can be stopped by neutralizing, or releasing, the controls for a long enough period to break the cycle.

#### 2.4.4 Combination of Causes

A single cause of an airplane upset can be the initiator of other causes. In one instance, a possible inadvertent movement of the flap/slat handle resulted in the extension of the leading edge slats. The captain’s initial reaction to counter the pitchup was to exert forward control column force; the control force when the autopilot disconnected resulted in an abrupt airplane nosedown elevator command. Subsequent commanded elevator movements to correct the pitch attitude induced several violent pitch oscillations. The captain’s commanded elevator movements were greater than necessary because of the airplane’s light control force characteristics. The oscillations resulted in a loss of 5000 ft of altitude. The maximum nose-down pitch attitude was greater than 20 deg, and the maximum normal accelerations were greater than 2 g and less than 1 g.

This incident lends credence to the principle used throughout this training aid: ***Reduce the level of automation while initiating recovery; that is, disconnect the autopilot and autothrottle, and do not let the recovery from one upset lead to another by excessive use of the controls.***

### 2.5 Swept-Wing Airplane Fundamentals for Pilots

Aircraft are designed, tested, and certified based on accepted assumptions of how pilots will operate them, together with various environmental and technical constraints (e.g., gusts, engine failure dynamics). These assumptions drive the regulatory certification requirements and are validated through in-service experience. The certification flight test process examines the entire flight envelope of the aircraft, including that area beyond which the airline pilot normally operates. Examples would be a fully stalled aircraft or airspeed exceeding  $V_{mo}$ . The process even explores how the aircraft could

possibly be inappropriately operated; however, the testing assumes fundamental flying skills are known and understood. A primary assumption regarding pilot inputs is that they are based on control inputs that are measured (the result of experience), analyzed, then fine-tuned to achieve a desired result. Exaggerated rates and amounts of control deflection (overcontrolling) may cause an accelerating divergence of flight path control until the input is countered.

### 2.5.1 Flight Dynamics

In understanding the flight dynamics of large, swept-wing transport airplanes, it is important to first understand what causes the forces and moments acting on the airplane and then move to what kinds of motion these forces cause. Finally, with this background, one can gain an understanding of how a pilot can control these forces and moments in order to direct the flight path.

Pilots *are expected* to make control inputs based on desired aircraft reaction. Control deflections at one point in the flight envelope might not be appropriate in another part of the flight envelope. Pilots must have a fundamental understanding of flight dynamics in order to correctly make these choices. They *should not* make mechanical control deflections and rote reactions to dynamic situations that require an understanding of these flight fundamentals.

Newton's first law states that an object at rest will tend to stay at rest, and an object in motion will tend to stay in motion in a straight line, unless acted on by an external force. This definition is fundamental to all motion, and it provides the foundation for all discussions of flight mechanics. A careful examination of this law reveals an important subtlety, which is the reference to motion in a straight line. If an airplane in motion is to deviate from a straight line, there must be a force, or a combination of forces, imposed to achieve the desired trajectory. The generation of the forces is the subject of aerodynamics (to be discussed later). The generation of forces requires energy.

### 2.5.2 Energy States

A pilot has three sources of energy available to manage or manipulate to generate aerodynamic forces and thus control the flight path of an airplane.

The term “energy state” describes how much of each kind of energy the airplane has available at any given time. Pilots who understand the airplane energy state will be in a position to know instantly what options they may have to maneuver their airplane. The three sources of energy available to the pilot are

- a. Kinetic energy, which increases with increasing airspeed.
- b. Potential energy, which is proportional to altitude.
- c. Chemical energy, from the fuel in the tanks.

The airplane is continuously expending energy; in flight, this is because of drag. (On the ground, wheel brakes and thrust reversers, as well as friction, dissipate energy.) This drag energy in flight is usually offset by using some of the stored chemical energy—by burning fuel in the engines.

During maneuvering, these three types of energy can be traded, or exchanged, usually at the cost of additional drag. This process of consciously manipulating the energy state of the airplane is referred to as “energy management.” Airspeed can be traded for altitude, as in a zoom-climb. Altitude can be traded for airspeed, as in a dive. Stored energy can be traded for either altitude or airspeed by advancing the throttles to command more thrust than required for level flight. The trading of energy must be accomplished, though, with a view toward the final desired energy state. For example, while altitude can be traded for airspeed by diving the airplane, care must be taken in selecting the angle of the dive so that the final desired energy state will be captured.

This becomes important when the pilot wants to generate aerodynamic forces and moments to maneuver the airplane. Only kinetic energy (airspeed) can generate aerodynamic forces and maneuver capability. Kinetic energy can be traded for potential energy (climb). Potential energy can only be converted to kinetic energy. Chemical energy can be converted to either potential or kinetic energy, but only at specified rates. These energy relationships are shown in Figure 10.

High-performance jet transport airplanes are designed to exhibit very low drag in the cruise configuration. This means that the penalty for trading airspeed for altitude is relatively small. Jet transport airplanes are also capable of gaining speed very rapidly in a descent. The pilot needs to exercise

considerable judgment in making very large energy trades. Just as the level flight acceleration capability is limited by the maximum thrust of the engines, the deceleration capability is limited by the ability to generate very large drag increments. For high-performance jet transport airplanes, the ability to generate large decelerating drag increments is often limited. The pilot always should be aware of these limitations for the airplane being flown. A very clean airplane operating near its limits can easily go from the low-speed boundary to and through the high-speed boundary very quickly.

The objective in maneuvering the airplane is to manage energy so that kinetic energy stays between limits (stall and placards), the potential energy stays within limits (terrain to buffet altitude), and chemical energy stays above certain thresholds (not running out of fuel). This objective is especially important during an inadvertent upset and the ensuing recovery.

In managing these energy states and trading between the various sources of energy, the pilot does not directly control the energy. The pilot controls the orientation and magnitude of the various forces acting on the airplane. These forces result in accelerations applied to the airplane. The result of these accelerations is a change in the orientation of the airplane and a change in the direction or magnitude, or both, of the flight path vector. Ultimately, velocity and altitude define the energy state.

This process of controlling forces to change accelerations and produce a new energy state takes time. The amount of time required is a function of the *mass* of the airplane and the *magnitude* of the

applied forces, and it is also governed by Newton's laws. Airplanes of larger mass generally take longer to change orientation than do smaller ones. The longer time requires the pilot to plan ahead more in a large-mass airplane and make sure that the actions taken will achieve the final desired energy state.

### 2.5.3 Load Factor

Load factor in the realm of flight mechanics is a measure of the acceleration being experienced by the airplane. By Newton's second law,

$$\text{force} = \text{mass} \times \text{acceleration}$$

Since the airplane has mass, if it is being accelerated there must be a force acting on it. Conversely, if there is a force acting on an airplane, it will accelerate. In this case, acceleration refers to a change in either magnitude or direction of the velocity. This definition of acceleration is much more broad than the commonplace reference to acceleration as simply "speeding up." Acceleration has dimensions (length/time<sup>2</sup>). It is convenient to refer to acceleration by comparing it to the acceleration due to gravity (which is 32.2 ft/s<sup>2</sup> or 9.81 m/s<sup>2</sup>). Acceleration is expressed in this way as units of gravity (g).

In addition, the acceleration (or load factor in g's) is typically discussed in terms of components relative to the principal axes of the airplane:

- Longitudinal (fore and aft, typically thought of as speed change).
- Lateral (sideways).
- Vertical (or normal).

Figure 10  
Energy  
Relationships

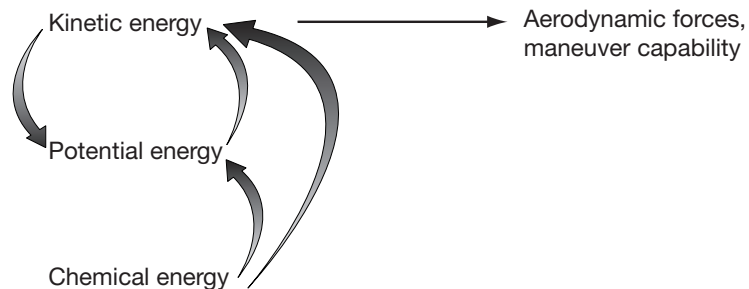

Frequently, load factor is thought of as being only perpendicular to the floor of the airplane. But the force, and thus the acceleration, may be at any orientation to the airplane, and the vertical, or normal, load factor represents only one component of the total acceleration. In sideslip, for example, there is a sideways acceleration, and the pilot feels pushed out of the seat sideways. In a steep climb or a rapid acceleration, the pilot feels forced back into the seat.

In level flight, the vertical load factor is one times the acceleration due to gravity, or 1.0 (Fig. 11). This

means that the wing is producing lift equal to 1.0 times the weight of the airplane, and it is oriented in a direction opposed to the gravity vector. In a pull-up, the load factor is above 1.0 (Fig. 12).

In the example in Figure 12, the load factor is 2.0. That is, the force generated by the airplane (wings, fuselage, etc.) is twice that of gravity. Also note that the flight path is now curved. Newton's first law says that an object will continue in a straight line unless acted on by a force. In this case, the lift force is acting in a perpendicular direction to the velocity, and the resulting flight path is curved.

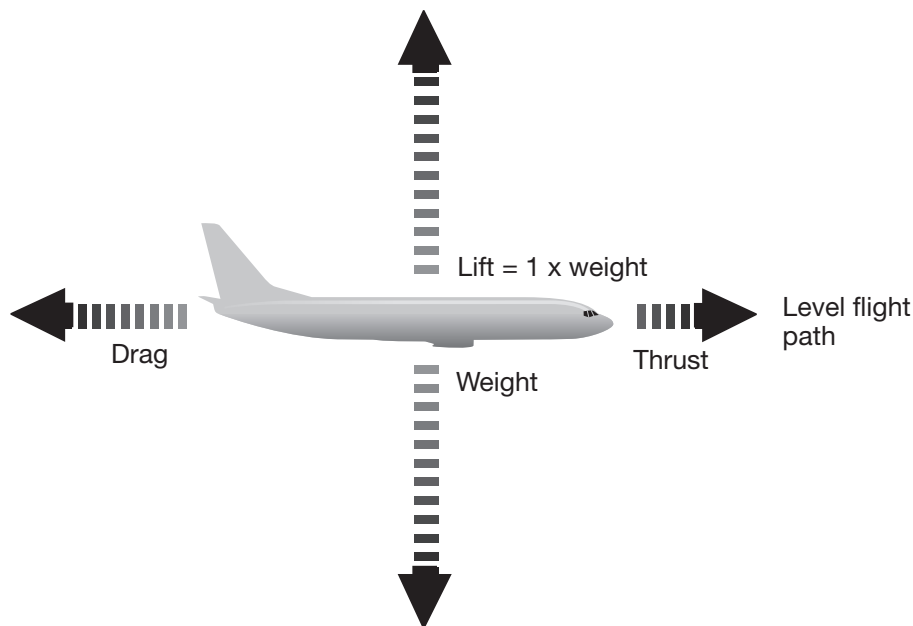

*Figure 11  
Four Forces of  
Flight*

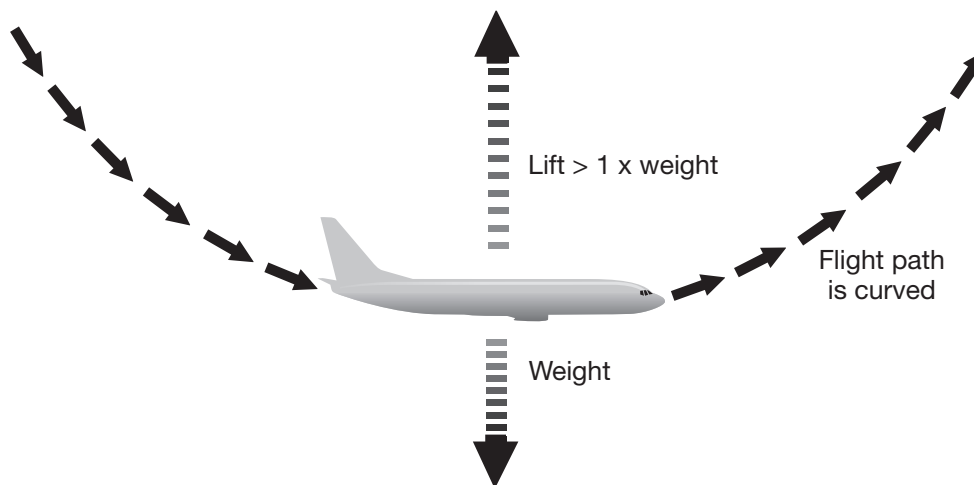

*Figure 12  
Airplane in  
Pull-Up*

In a sustained vertical climb along a straight line, the thrust must be greater than the weight and drag. The load factor perpendicular to the airplane floor must be zero (Fig. 13a).

If it were anything but zero, the flight path would not be a straight line (Fig. 13b).

Note that the acceleration is a result of the sum of all forces acting on the airplane. One of those forces is always gravity. Gravity always produces an acceleration directed toward the center of the Earth. The airplane attitude determines the direction of the gravitational force with respect to the airplane. Aerodynamic forces are produced as a result of orientation and magnitude of the velocity vector relative to the airplane, which is reduced into angles of attack and sideslip. (Refer to Sec. 2.5.5, "Aerodynamics", for a detailed discussion.) It is the direction and speed of the airplane through the air that results in aerodynamic forces (e.g., straight ahead or sideways, fast or slow). It is the orientation of the airplane to the center of the

Earth that determines the orientation of the gravity vector.

Current jet transport airplanes are certificated to withstand normal vertical load factors from  $-1.0$  to  $2.5$  g in the cruise configuration. Figure 14 is a typical v-n diagram for a transport airplane ("v" for velocity, "n" for number of g's acceleration). In addition to the strength of the structure, the handling qualities are demonstrated to be safe within these limits of load factor. This means that a pilot should be able to maneuver safely to and from these load factors at these speeds without needing exceptional strength or skill.

Pilots should be aware of the various weight, configuration, altitude, and bank angle specifics of the diagrams for the particular airplane they fly and of the limitations imposed by them.

Design maneuver speed,  $V_A$ , is identified in the Airplane Flight Manual (AFM). It was a design condition the manufacturer used to demonstrate

Figure 13a  
Airplane Vertical  
With Forces  
Balanced

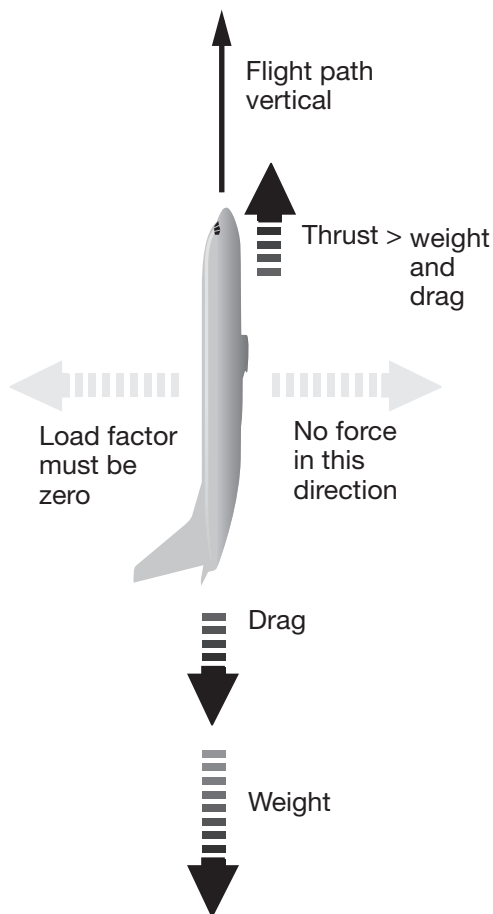
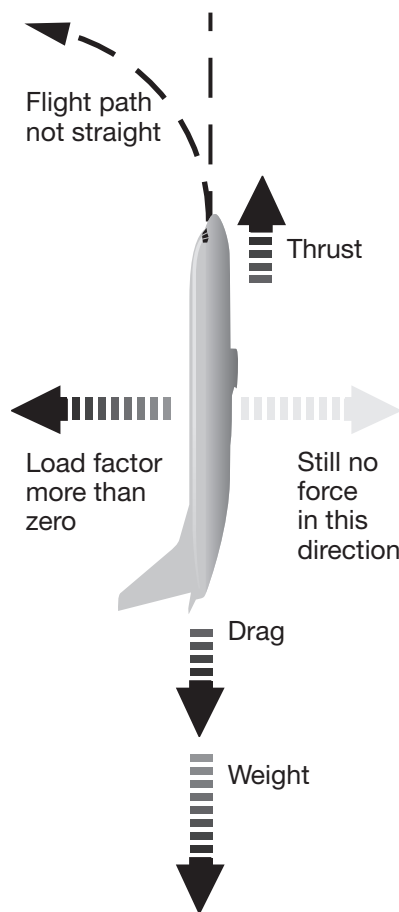

Figure 13b  
(right)  
Airplane Vertical  
With Forces  
Unbalanced



the structural capability of the airplane. It is used to validate design criteria, and because it varies with altitude, it is of limited use to a pilot. Only single flight control inputs are considered and calculated. Control reversals are not considered in design and certification and must be avoided. We recommend that pilots use turbulence penetration speed as a reference speed above which abrupt control inputs should be avoided.

$V_A$  should not be confused with minimum or configuration maneuver speed, which is the recommended minimum speed for maneuvering at various flap/slat configurations. On many modern airplanes, minimum or configuration maneuver speed is the minimum speed that autothrottles/autothrust will control to.

### 2.5.4 Aerodynamic Flight Envelope

Airplanes are designed to be operated in well-defined envelopes of airspeed and altitude. The operational limits for an airplane—stall speeds, placarded maximum speeds and Mach numbers, and maximum certificated altitudes—are in the AFM for each individual airplane. Within these limits, the airplanes have been shown to exhibit safe flight characteristics.

Manufacturing and regulatory test pilots have evaluated the characteristics of airplanes in conditions that include inadvertent exceedances of these operational envelopes to demonstrate that the airplanes can be returned safely to the operational envelopes. Figure 15 depicts a typical flight envelope.  $M_{MO}$  and  $V_{MO}$  are the operational limitations,

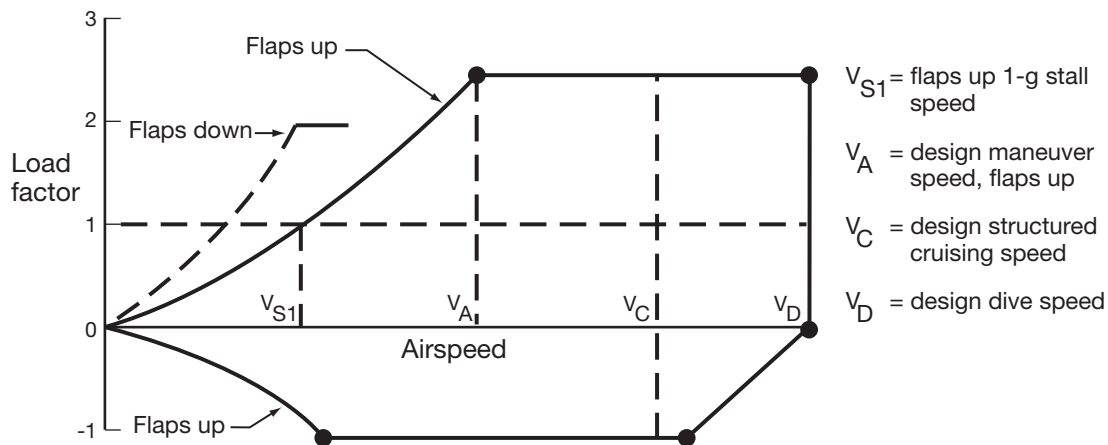

Figure 14 Load Factor Envelope Showing Speeds and Load Factors

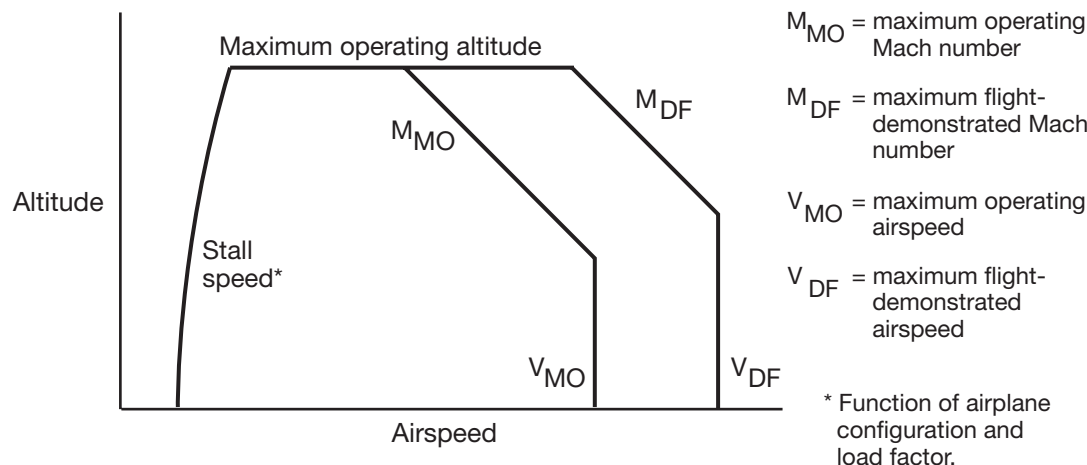

Figure 15 Aerodynamic Flight Envelope

but the figure also shows the relationship to  $M_{DF}$  and  $V_{DF}$ , the maximum dive speeds demonstrated in flight test. These are typically 0.05 to 0.07 Mach and 50 kn higher than the operational limits. In the region between the operational envelope and the dive envelope, the airplane is required to exhibit safe characteristics. Although the characteristics are allowed to be degraded in that region from those within the operational flight envelope, they are shown to be adequate to return the airplane to the operational envelope if the airplane is outside the operational envelope.

### 2.5.5 Aerodynamics

Aside from gravity and thrust forces, the other forces acting on an airplane are generated as a result of the changing pressures produced on the surfaces that result in turn from the air flowing over them. A brief review of basic fundamental aerodynamic principles will set the stage for discussion of airplane upset flight dynamics.

#### 2.5.5.1 Angle of Attack and Stall

Most force-generating surfaces on modern jet transport airplanes are carefully tailored to generate lifting forces efficiently. Wings and tail surfaces all produce lift forces in the same way. Figure 16 shows a cross section of a lifting surface and the familiar definition of angle of attack. The lift force in pounds generated by a surface is a function of the angle of attack, the dynamic pressure (which is proportional to the air density and the square of the true airspeed) of the air moving around it, and the size of the surface.

It is important to understand the dependence of lift on angle of attack. Figure 17 shows how lift varies with angle of attack for constant speed and air density. Important features of this dependency include the fact that at zero angle of attack, lift is not zero. This is because most lifting surfaces are cambered. Further, as angle of attack is increased, lift increases proportionally, and this increase in lift is normally quite linear. At higher angles of attack, however, the lift due to angle of attack behaves differently.

Figure 16  
Airfoil at Angle of Attack

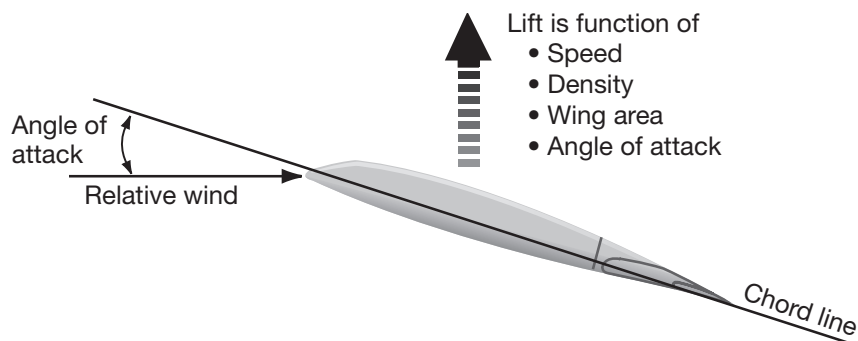
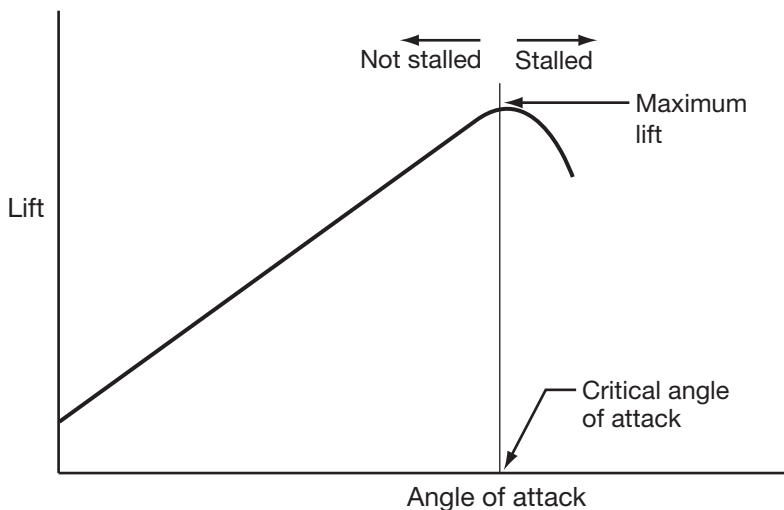

Figure 17  
Lift at Angle of Attack



Instead of increasing with an increase in angle of attack, it decreases. At this critical angle of attack, the air moving over the upper surface can no longer remain attached to the surface, the flow breaks down, and the surface is considered stalled.

It is necessary to understand that this breakdown of the flow and consequent loss of lift is dependent only on the angle of attack of the surface. **Exceed the critical angle of attack and the surface will stall, and lift will decrease instead of increasing. This is true regardless of airplane speed or attitude.** To sustain a lifting force on the aerodynamic surfaces, the pilot must ensure that the surfaces are flown at an angle of attack below the stall angle, that is, avoid stalling the airplane.

Depending on the context in which it is used, aerodynamicists use the term “angle of attack” in a number of ways. Angle of attack is always the angle between the oncoming air, or relative wind, and some reference line on the airplane or wing. Sometimes it is referenced to the chord line at a particular location on the wing; sometimes to an “average” chord line on the wing; other times it is referenced to a convenient reference line on the airplane, like the body reference x axis. Regardless of the reference, the concept is the same as are the consequences: exceed the critical angle of attack and the lifting surfaces and wind will separate, resulting in a loss of lift on those surfaces. Frequently the term “airplane angle of attack” is used to refer to the angle between the relative wind and the longitudinal axis of the airplane. In flight dynamics, this is frequently reduced to simply “angle of attack.”

Angle of attack can sometimes be confusing because there is not typically an angle-of-attack indicator in most commercial jet transport airplanes. The three angles usually referred to in the longitudinal axis are

- a. Angle of attack.
- b. Flight path angle.
- c. Pitch attitude.

These three angles and their relationships to each other are shown in Figure 18.

Pitch attitude, or angle, is the angle between the longitudinal axis of the airplane and the horizon. This angle is displayed on the attitude indicator or artificial horizon.

The flight path angle is the angle between the flight path vector and the horizon. This is also the climb (or descent angle). On the newest generation jet transports, this angle can be displayed on the primary flight display (PFD), as depicted in Figure 18. Flight path angle can also be inferred from the vertical speed indicator (VSI) or altimeter, if the ground speed is known. Many standard instrument departures require knowledge of flight path angle in order to ensure obstacle clearance.

Angle of attack is also the difference between the pitch attitude and the flight path angle with no vertical wind component. The angle of attack determines whether the aerodynamic surfaces on the airplane are stalled or not.

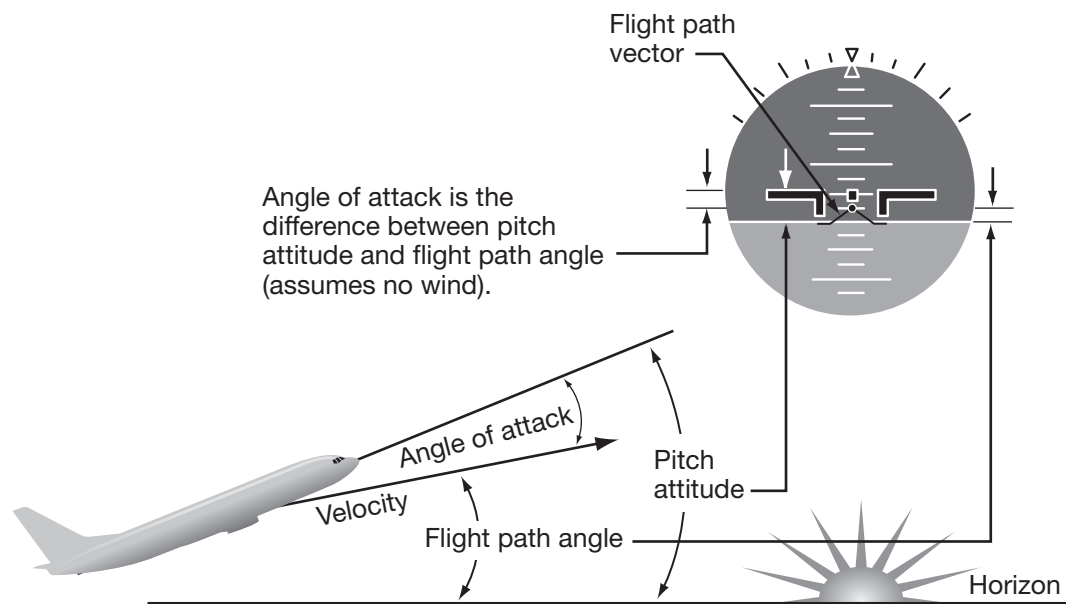

Figure 18  
Pitch Attitude,  
Flight Path Angle,  
and Angle of  
Attack



The important point is that when the angle of attack is above the stall angle, the lifting capability of the surface is diminished. This is true regardless of airspeed. An airplane wing can be stalled at any airspeed. An airplane can be stalled in any attitude. If the angle of attack is greater than the stall angle, the surface will stall. Figure 19 indicates that regardless of the airspeed or pitch attitude of the airplane, the angle of attack determines whether the wing is stalled.

A stall is characterized by any or a combination of the following:

- Buffeting, which could be heavy.
- Lack of pitch authority.
- Lack of roll control.
- Inability to arrest descent rate.

These characteristics are usually accompanied by a continuous stall warning. A stall must not be confused with an approach-to-stall warning that occurs before the stall and warns of an approaching stall. An approach to stall is a controlled flight maneuver. However, a full stall is an out-of-control condition, but it is recoverable.

Stall speeds are published in the AFM for each transport airplane, giving the speeds at which the airplane will stall as a function of weight. This information is very important to the pilot, but it must be understood that the concept of stall speed is very carefully defined for specific conditions:

- Trim at  $1.3 V_S$ .
- Forward CG.
- Low altitudes.
- Deceleration rate of 1 kn/s.
- Wings level.
- Approximately 1-g flight.

Under normal conditions, the wings are level or near level, and the normal load factor is very near 1.0. Under these conditions, the published stall speeds give the pilot an idea of the proximity to stall. In conditions other than these, however, the speed at stall is not the same as the “stall speed.” Aerodynamic stall depends only on angle of attack, and it has a specific relationship to stall speed only under the strict conditions previously noted. Many upsets are quite dynamic in nature and involve elevated load factors and large speed-change rates. Pilots

*Figure 19  
Several Pitch  
Attitudes and Stall  
Angle of Attack*

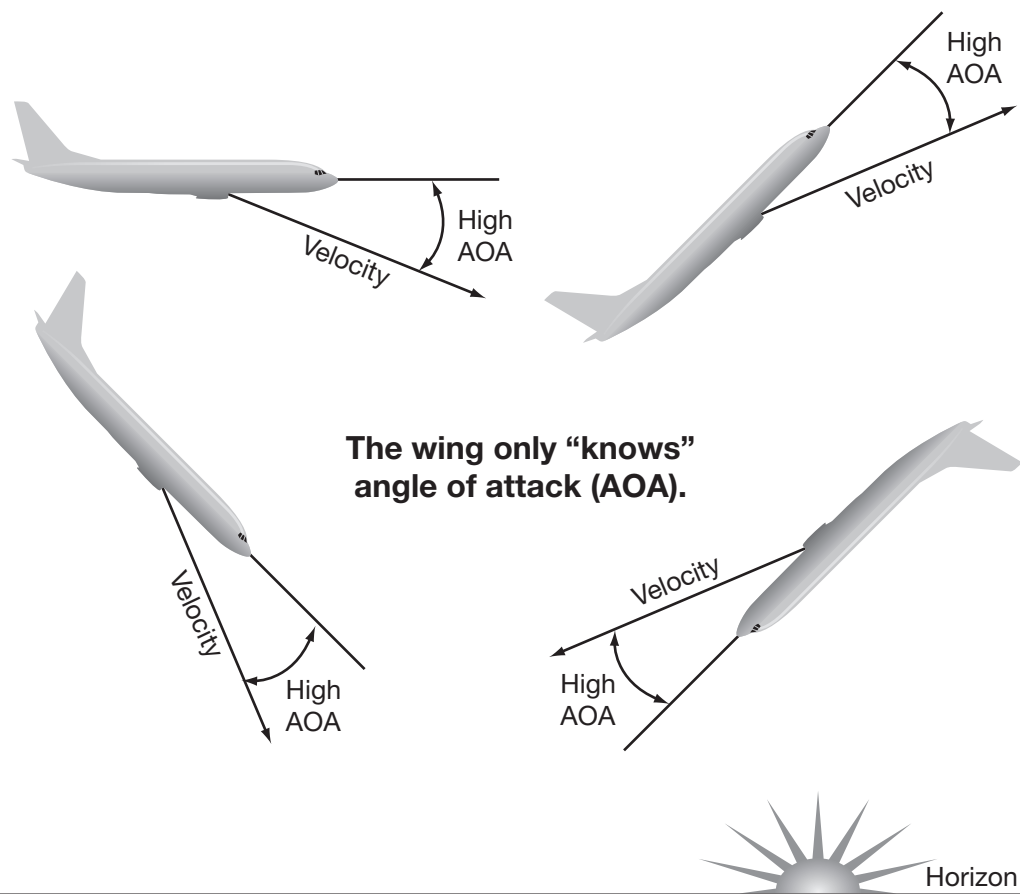

should not expect the airplane to remain unstalled just because the indicated airspeed is higher than AFM chart speeds, because the conditions may be different.

All modern jet transports are certified to exhibit adequate warning of impending stall to give the pilot opportunity to recover by decreasing the angle of attack. Whether this warning is by natural aerodynamic buffet or provided by a stick shaker or other warning devices, it warns the pilot when the angle of attack is getting close to stall. Moreover, the warning is required to be in a form other than visual. The pilot need not look at a particular instrument, gauge, or indicator. The warning is tactile: the pilot is able to feel the stall warning with enough opportunity to recover promptly. Pilots need to be especially cognizant of stall warning cues for the particular airplanes they fly. The onset of stall warning should be taken as an indication to not continue to increase the angle of attack.

The angle of attack at which a wing stalls reduces with increasing Mach so that at high Mach (normally, high altitude), an airplane may enter an accelerated stall at an angle of attack that is less than the angle of attack for stalling at lower Mach numbers.

**2.5.5.2 Camber**

Camber refers to the amount of curvature evident in an airfoil shape. Camber is illustrated in Figure 20. The mean camber line is a line connecting the mid-points of upper and lower surfaces of an airfoil. In contrast, the chord line is a straight line connecting the leading and trailing edges.

Technical aerodynamicists have defined camber in a variety of ways over the years, but the reason for introducing camber has remained the same: airfoils with camber are more efficient at producing lift than those without. Importantly, airfoils with specific kinds of camber at specific places are more efficient than those of slightly different shape.

Airplanes that must produce lift as efficiently up as well as down, such as competition aerobatics airplanes, usually employ symmetrical airfoils. These work well, but they are not as efficient for cruise flight. Efficient, high-speed airplanes often employ exotic camber shapes because they have been found to have beneficial drag levels at high speeds. Depending on the mission the airplane is intended to fly, the aerodynamic surfaces are given an optimized camber shape. While both cambered and uncambered surfaces produce lift at angle of attack, camber usually produces lift more efficiently than angle of attack alone.

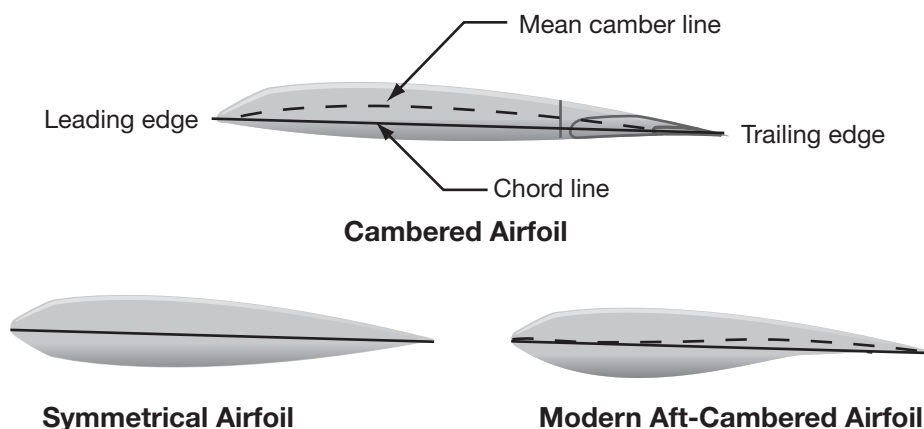

*Figure 20  
Camber  
Definition*

### 2.5.5.3 Control Surface Fundamentals

Trailing edge control surfaces such as ailerons, rudders, and elevators provide a way of modulating the lift on a surface without physically changing the angle of attack. These devices work by altering the camber of the surfaces. Figure 21 shows undeflected and deflected control surfaces.

The aerodynamic effect is that of increasing the lift at constant angle of attack for trailing edge down deflection. This is shown in Figure 22. The price paid for this increased lift at constant angle of attack is a reduced angle of attack for stall. Note that for larger deflections, even though the lift is greater, the stall angle of attack is lower than that at no deflection.

The important point is that increasing camber (downward deflection of ailerons, for example) lowers the angle of attack at which stall occurs. Large downward aileron deflections at very high angles of attack could induce air separation over that portion of the wing. Reducing the angle of attack before making large aileron deflections will help ensure that those surfaces are as effective as they can be in producing roll.

### 2.5.5.3.1 Spoiler-Type Devices

Spoilers, sometimes referred to as “speedbrakes” on large transport airplanes, serve a dual purpose of “spoiling” wing lift and generating additional drag. By hinging upwards from the wing upper surface, they generate an upper surface discontinuity that the airflow cannot negotiate, and they separate, or stall, the wing surface locally. Figure 23 depicts spoiler operation with both flaps up and flaps down. The effectiveness of spoiler devices depends on how much lift the wing is generating (which the spoiler will “spoil”). If the wing is not producing much lift to begin with, spoiling it will not produce much effect. If the wing is producing large amounts of lift, as is the case with the flaps extended and at moderate angles of attack, the spoilers become very effective control devices because there is more lift to spoil.

Because spoilers depend on there being some lift to “spoil” in order to be effective, they also lose much of their effectiveness when the wing is in a stalled condition. If the flow is already separated, putting a spoiler up will not induce any more separation. As was the case with aileron control at high angles of attack, it is important to know that the wing must

Figure 21  
Deflected  
Surfaces

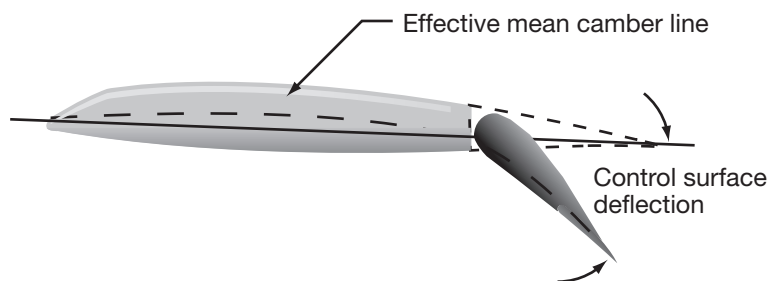
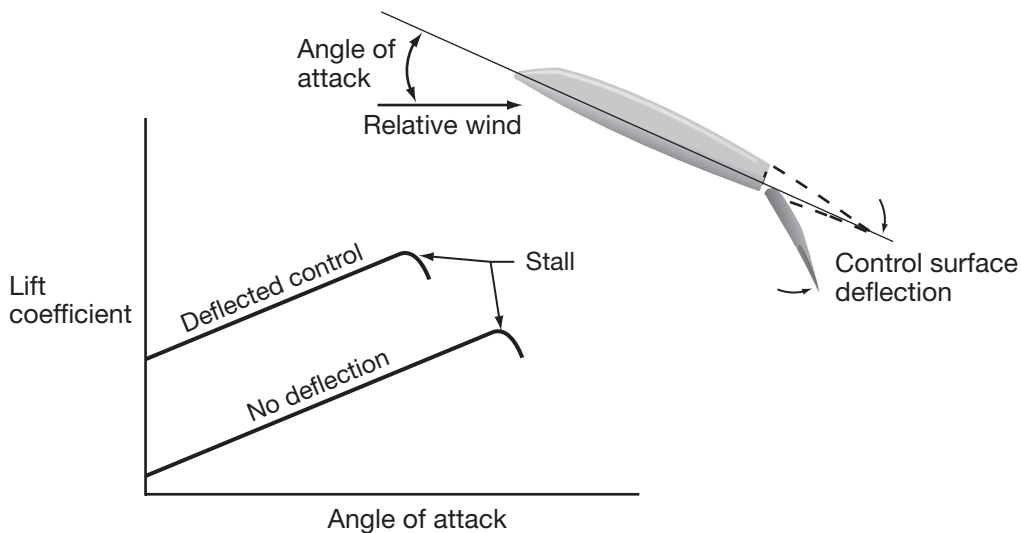

Figure 22  
Lift Characteristics  
for Deflected Trailing  
Edge Surfaces



be unstalled in order for the aerodynamic controls to be effective.

**2.5.5.3.2 Trim**

Aerodynamicists refer to “trim” as that condition in which the forces on the airplane are stabilized and the moments about the center of gravity all add up to zero. Pilots refer to “trim” as that condition in which the airplane will continue to fly in the manner desired when the controls are released. In reality, both conditions must be met for the airplane to be “in trim.” In the pitch axis, aerodynamic, or moment, trim is achieved by varying the lift on the horizontal tail/elevator combination to balance the pitching moments about the center of gravity. Once the proper amount of lift on the tail is achieved, means must be provided to keep it constant. Traditionally, there have been three ways of doing that: fixed stabilizer/trim tab, all-flying tail, and trimmable stabilizer.

In the case of the fixed stabilizer/trim tab configuration, the required tail load is generated by deflecting the elevator. The trim tab is then deflected in such a way as to get the aerodynamics of the tab to hold the elevator in the desired position. The airplane is then in trim (because the required load on the tail has been achieved) and the column force trim condition is met as well (because the tab holds the elevator in the desired position). One side effect of this configuration is that when trimmed near one end of the deflection range, there is not much more control available for maneuvering in that direction (Fig. 24).

In the case of the all-flying tail, the entire stabilizer moves as one unit in response to column commands. This changing of the angle of attack of the stabilizer adjusts the tail lift as required to balance the moments. The tail is then held in the desired position by an irreversible flight control system (usually hydraulic). This configuration requires a very powerful and fast-acting control system to

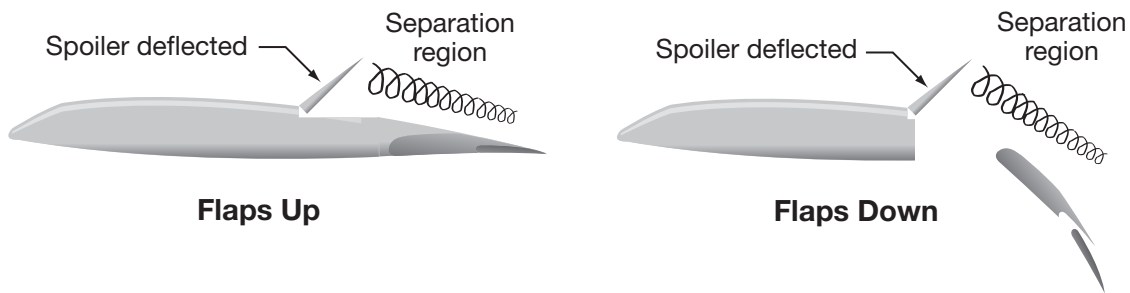

Figure 23  
Spoiler Devices

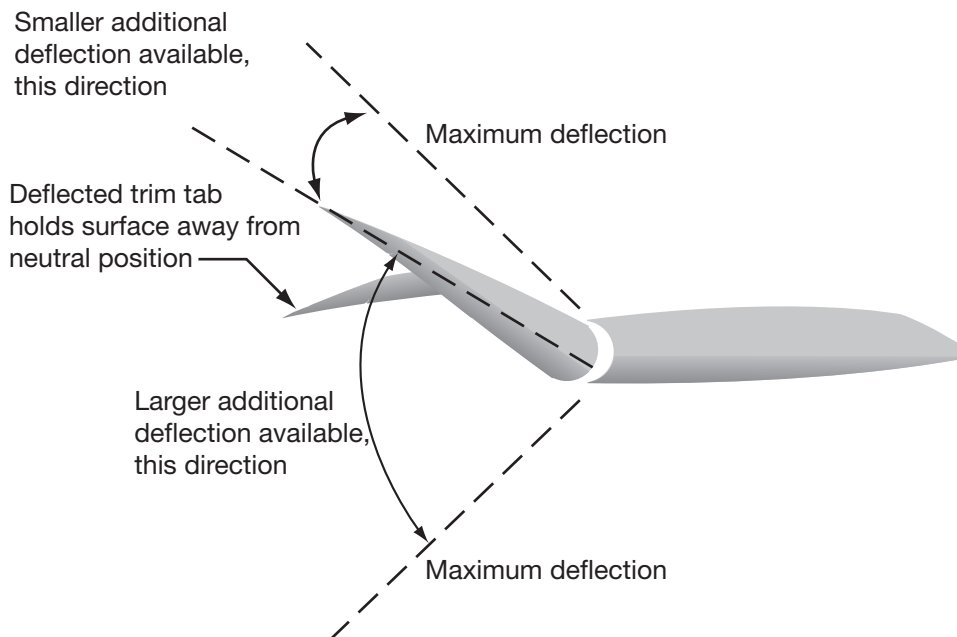

Figure 24  
Typical  
Trimmable Tails

move the entire tail in response to pilot inputs, but it has been used quite successfully on commercial jet transport airplanes.

In the case of the trimmable stabilizer, the proper pitching moment is achieved by deflecting the elevator and generating the required lift on the tail. The stabilizer is then moved (changing its angle of attack) until the required tail lift is generated by the stabilizer with the elevator essentially at zero deflection. A side effect of this configuration is that from the trimmed condition, full elevator deflection is available in either direction, allowing a much larger range of maneuvering capability. This is the configuration found on most high-performance airplanes that must operate through a very wide speed range and that use very powerful high-lift devices (flaps) on the wing.

Knowing that in the trimmed condition the elevator is nearly faired or at zero deflection, the pilot instantly knows how much control power is available in either direction. This is a powerful tactile cue, and it gives the pilot freedom to maneuver without the

danger of becoming too close to surface stops.

**2.5.5.4 Lateral and Directional Aerodynamic Considerations**

Aerodynamically, anti-symmetric flight, or flight in sideslip, can be quite complex. The forces and moments generated by the sideslip can affect motion in all three axes of the airplane. As will be seen, sideslip can generate strong aerodynamic rolling moments as well as yawing moments. In particular, the magnitude of the coupled roll-due-to-sideslip is determined by several factors.

**2.5.5.4.1 Angle of Sideslip**

Just as airplane angle of attack is the angle between the longitudinal axis of the airplane and the relative wind as seen in a profile view, the sideslip angle is the angle between the longitudinal axis of the airplane and the relative wind, seen this time in the plan view (Fig. 25). It is a measure of whether the airplane is flying straight into the relative wind.

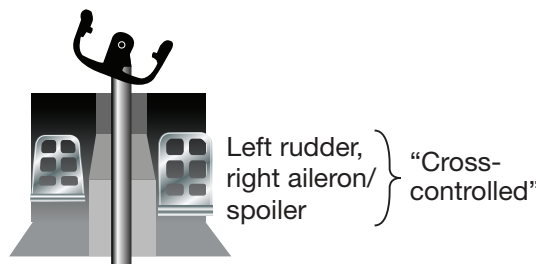
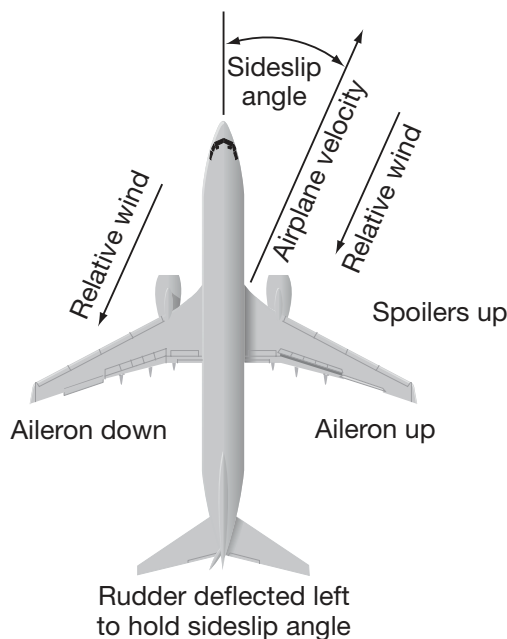

Figure 25  
Angle of Sideslip



With the exception of crosswind landing considerations requiring pilot-commanded sideslip, commercial transport airplanes are typically flown at or very near zero sideslip. This usually results in the lowest cruise drag and is most comfortable for passengers, as the sideways forces are minimized.

For those cases in which the pilot commands a sideslip, the aerodynamic picture becomes a bit more complex. Figure 25 depicts an airplane in a commanded nose-left sideslip. That is, the velocity vector is not aligned with the longitudinal axis of the airplane, and the relative wind is coming from the pilot's right.

One purpose of the vertical tail is to keep the nose of the airplane "pointed into the wind," or make the tail follow the nose. When a sideslip angle is developed, the vertical tail is at an angle of attack and generates "lift" that points sideways, tending to return the airplane to zero sideslip. Commercial jet transport airplanes are certificated to exhibit static directional stability that tends to return the airplane to zero sideslip when controls are released or returned to a neutral position. In order to hold a sideslip condition, the pilot must hold the rudder in a deflected position (assuming symmetrical thrust).

#### 2.5.5.4.2 Wing Dihedral Effects

Dihedral is the positive angle formed between the lateral axis of an airplane and a line that passes through the center of the wing, as depicted in Figure 26. Dihedral contributes to the lateral stability of an airplane, and commercial jet transport airplanes are certificated to exhibit static lateral stability. A wing with dihedral will develop stable rolling moments with sideslip. If the relative wind comes from the side, the wing into the wind is subject to an increase in lift. The wing away from the wind is subject to a decrease in angle of attack and develops a decrease in lift. The changes in lift effect a rolling moment, tending to raise the windward wing; hence, dihedral contributes a stable roll due to sideslip. Since wing

dihedral is so powerful in producing lateral stability, it is used as a "common denominator term" of the lateral stability contribution of other airplane components, such as rudder and wing sweep. In other words, the term "dihedral effect" is used when describing the effects of wing sweep and rudder on lateral stability and control.

A swept-wing design used on jet transport airplanes is beneficial for high-speed flight, since higher flight speeds may be obtained before components of speed perpendicular to the leading edge produce critical conditions on the wing. In other words, wing sweep will delay the onset of compressibility effects. This wing sweep also contributes to the dihedral effect. When the swept-wing airplane is placed in a sideslip, the wing into the wind experiences an increase in lift, since the effective sweep is less, and the wing away from the wind produces less lift, since the effective sweep is greater (Fig. 25). The amount of contribution, or dihedral effect, depends on the amount of sweepback and lift coefficient of the wing. The effect becomes greater with increasing lift coefficient and wing sweep. The lift coefficient will increase with increasing angle of attack up to the critical angle. This means that any sideslip results in more rolling moment on a swept-wing airplane than on a straight-wing airplane. Lateral controls on swept-wing airplanes are powerful enough to control large sideslip angles at operational speeds.

Rudder input produces sideslip and contributes to the dihedral effect. The effect is proportional to the angle of sideslip. (That is, roll increases with sideslip angle; therefore, roll increases with increasing rudder input.) Precise control of roll angle using this technique is very difficult, and therefore, not recommended. The next section discusses this area in more detail. When an airplane is at a high angle of attack, aileron and spoiler roll controls become less effective. At the stall angle of attack, the rudder is still effective; therefore, it can produce large sideslip angles, which in turn produces roll because of the dihedral effect.



Figure 26  
Wing Dihedral Angle

### 2.5.5.4.3 Pilot-Commanded Sideslip

The rudders on modern jet transport airplanes are sized to counter the yawing moment associated with an engine failure at very low takeoff speeds and to ensure yaw control throughout the flight envelope, using up to maximum pedal input. This very powerful rudder is also capable of generating large sideslips. An inappropriate rudder input can produce a large sideslip angle, which will generate a large rolling moment that requires significant lateral control input to stop the airplane from rolling. The rudder should not normally be used to induce roll through sideslip because the transient sideslip can induce very rapid roll rates with significant time delay. The combination of rapid roll rates and time delay can startle the pilot, which in turn can cause the pilot to overreact in the opposite direction. The overreaction can induce abrupt yawing moments and violent out-of-phase roll rates, which can lead to successive cyclic rudder deflections, known as rudder reversals. *Large aggressive control reversals can lead to loads that can exceed structural design limits.* Figure 27 shows sideslip response to abrupt cyclic rudder input. Except in crosswind takeoff and landing, keeping the sideslip as close to zero as possible will ensure that the maximum amount of lateral control is available for maneuvering. On modern jet airplanes, the specific deflection combinations of ailerons and spoilers, with yaw dampers and turn coordinators, are usually designed to make adverse yaw undetectable to the pilot; hence the use of rudder is virtually eliminated during normal roll conditions. In any case, use of coordinated rudder in combination with ailerons/spoilers is to eliminate yaw and not to supplement or induce roll.

One way to determine the sideslip state of the airplane is to “feel” the lateral acceleration; it feels as if the pilot is being pushed out of the seat sideways.

Another way is to examine the slip-skid indicator and keep the ball in the center. Pilots should develop a feel for the particular airplanes they fly and understand how to minimize sideslip angle through coordinated use of flight controls.

### 2.5.5.4.4 Crossover Speed

Crossover speed is a recently coined term that describes the lateral controllability of an airplane with the rudder at a fixed (up to maximum) deflection. It is the minimum speed (weight and configuration dependent) in a 1-g flight, where maximum aileron/spoiler input (against the stops) is reached and the wings are still level or at an angle to maintain directional control. Any additional rudder input or decrease in speed will result in an unstoppable roll into the direction of the deflected rudder or in an inability to maintain desired heading. Crossover speed is very similar in concept to  $V_{mca}$ , except that instead of being  $V_{mc}$  due to a thrust asymmetry, it is  $V_{mc}$  due to full rudder input. This crossover speed is weight and configuration dependent. However, it is also sensitive to angle of attack. With weight and configuration held constant, the crossover speed will increase with increased angle of attack and will decrease with decreased angle of attack. Thus, in an airplane upset due to rudder deflection with large and increasing bank angle and the nose rapidly falling below the horizon, the input of additional nose-up elevator with already maximum input of aileron/spoilers will only aggravate the situation. The correct action in this case is to unload the airplane to reduce the angle of attack, which will regain aileron/spoiler effectiveness and allow recovery. This action may not be intuitive and will result in a loss of altitude.

Note: The previous discussion refers to the aerody-

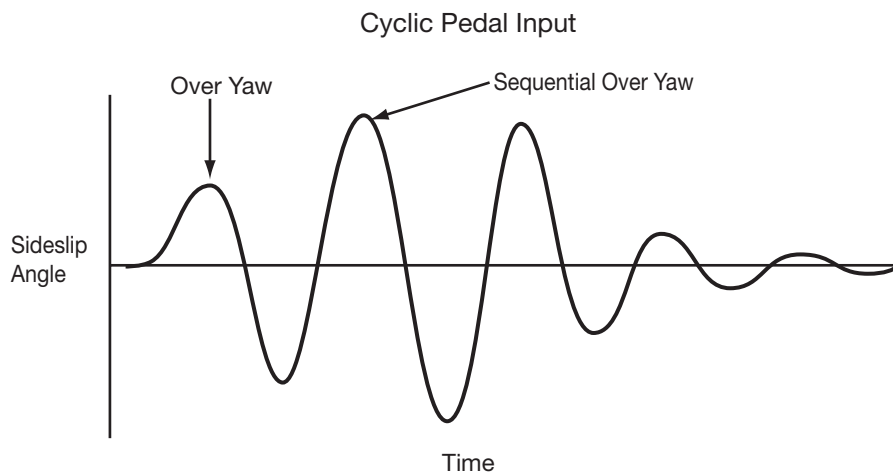

Figure 27  
Sideslip Response  
to Abrupt Cyclic  
Rudder Input

dynamic effects associated with rudder input; however, similar aerodynamic effects are associated with other surfaces.

### 2.5.5.5 Stability

Positive static stability is defined as the initial tendency to return to an undisturbed state after a disturbance. This concept has been illustrated by the “ball in a cup” model (Fig. 28).

All transport airplanes demonstrate positive stability in at least some sense. The importance here is that the concept of stability can apply to a number of different parameters, all at the same time. Speed stability, the condition of an airplane returning to its initial trim airspeed after a disturbance, is familiar to most pilots. The same concept applies to Mach number. This stability can be independent of airspeed if, for example, the airplane crosses a cold front. When the outside air temperature changes, the Mach number changes, even though the indicated airspeed may not change. Airplanes that are “Mach stable” will tend to return to the original Mach number. Many jet transport airplanes incorporate

Mach trim to provide this function. Similarly, commercial airplanes are stable with respect to load factor. When a gust or other disturbance generates a load factor, the airplane is certificated to be stable: it will return to its initial trimmed load factor (usually 1.0). This “maneuvering stability” requires a sustained pull force to remain at elevated load factors—as in a steep turn.

One important side effect of stability is that it allows for some unattended operation. If the pilot releases the controls for a short period of time, stability will help keep the airplane at the condition at which it was left.

Another important side effect of stability is that of tactile feedback to the pilot. On airplanes with static longitudinal stability, for example, if the pilot is holding a sustained pull force, the speed is probably slower than the last trim speed.

### 2.5.5.6 Maneuvering in Pitch

Movement about the lateral axis is called “pitch,” as depicted in Figure 29.

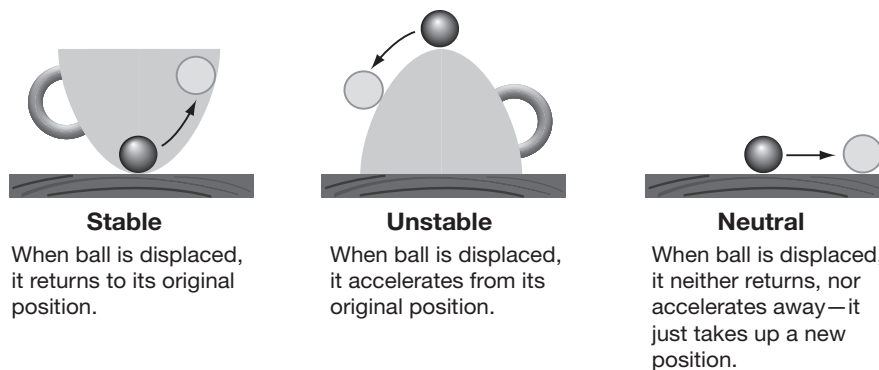

Figure 28  
Static Stability

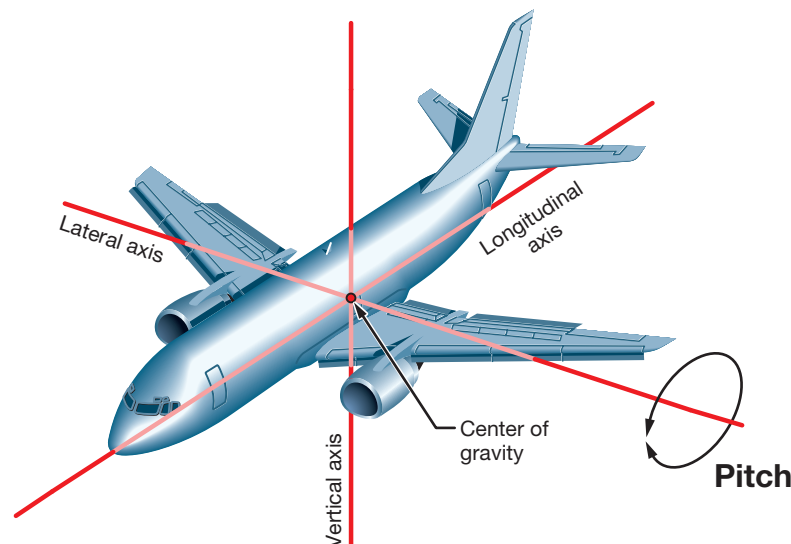

Figure 29  
Reference Axis  
Definitions



Controlling pitching motions involves controlling aerodynamic and other moments about the center of gravity to modulate the angle of attack. Aside from the pitching moment effects of thrust when engines are offset from the center of gravity (discussed below), the pilot controls the pitching moments (and therefore the angle of attack) by means of the stabilizer and elevator. The horizontal stabilizer should be thought of as a trimming device, reducing the need to hold elevator deflection, while the elevator should be thought of as the primary maneuvering control. This is true because the horizontal stabilizer has only limited rate capability—it cannot change angle very quickly. Maneuvering, or active pilot modulation of the pitch controls, is usually accomplished by the elevator control, which is designed to move at much faster rates. To get a better understanding of how these components work together, the following discussion will examine the various components of pitching moment.

“Moments” have dimensions of force times distance. Pilots are familiar with moments from working weight and balance problems. In the case of pitching moment, we are concerned with moments about the center of gravity. So the pitching moment due to wing lift, for example, is the wing lift times the distance between the center of gravity and the center of the wing lift. Since weight acts through the center of gravity, there is no moment associated with it. In addition, there is a moment associated with the fact that the wing is usually cambered and with the fact that the fuselage is flying in the wing’s flowfield. This wing-body moment does not have a

force associated with it; it is a pure torque.

Figure 30 shows many of the important components of pitching moment about the center of gravity of an airplane. Weight acts through the center of gravity and always points toward the center of the Earth. In steady (unaccelerated) flight, the moments about the center of gravity, as well as the forces, are all balanced: the sum is zero. Since, in general, there is a pitching moment due to the wing and body and the lift is not generally aligned with the center of gravity—and the thrust of the engines is also offset from the center of gravity—there is usually some load on the horizontal tail required to balance the rest of the moments, and that load is generally in the downward direction, as shown in the figure.

Essentially, the pilot controls the amount of lift generated by the horizontal tail (by moving the elevator), which adjusts the angle of attack of the wing and therefore modulates the amount of lift that the wing generates. Similarly, since engines are rarely aligned with the center of gravity, changing the thrust will be accompanied by a change in the pitching moment around the center of gravity. The pilot then adjusts the lift on the tail (with the elevator) to again balance the pitching moments.

As long as the angle of attack is within unstalled limits and the airspeed is within limits, the aerodynamic controls will work to maneuver the airplane in the pitch axis as described. This is true regardless of the attitude of the airplane or the orientation of the weight vector.

Figure 30  
Airplane Pitching  
Moments

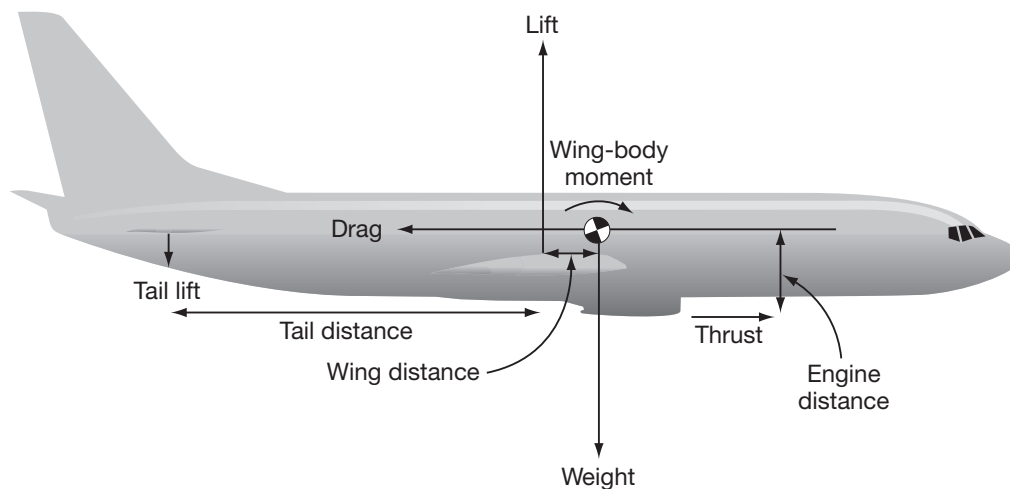

$$\begin{aligned}
 & (\text{Moment})_{\text{Tail}} + (\text{Moment})_{\text{Lift}} + (\text{Moment})_{\text{Thrust}} + (\text{Moment})_{\text{Wing-body}} = \text{Total pitching moment} \\
 & \left( \text{Tail lift} * \text{Tail distance} \right) + \left( \text{Wing lift} * \text{Wing distance} \right) + \left( \text{Thrust} * \text{Engine distance} \right) + (\text{Moment})_{\text{Wing-body}} = \text{Total pitching moment}
 \end{aligned}$$

Recall that the object of maneuvering the airplane is to manipulate the forces on the airplane in order to manage the energy state. The aerodynamic forces are a function of how the pilot manipulates the controls, changing angle of attack, for example. Similarly, the thrust forces are commanded by the pilot. The weight vector always points toward the center of the Earth. The orientation with respect to the airplane, though, is a function of the airplane attitude. The weight vector is a very powerful force. Recall that transport airplanes are certificated to 2.5 g. That means that the wing is capable of generating 2.5 times the airplane weight. In contrast, engine thrust is typically on the order of 0.3 times the airplane weight at takeoff weights.

To get an appreciation for the magnitude of the weight vector and the importance of its orientation, consider the very simple example of Figure 31.

In a noseup pitch attitude, the component of the weight vector in the drag direction (parallel to the airplane longitudinal axis) equals the engine thrust

at about 20 deg, noseup pitch attitude on a takeoff climb. Conversely, at nosedown pitch attitudes, the weight vector contributes to thrust. Since the magnitude of the weight vector is on the order of 3 times the available thrust, pilots need to be very careful about making large pitch attitude changes. When procedures call for a pitch attitude reduction to accelerate and clean up after takeoff, one aspect of that maneuver is getting rid of the weight component in the drag direction, allowing the airplane to gain speed.

### 2.5.5.7 Mechanics of Turning Flight

Recalling that Newton's laws dictate that an object in motion will continue in a straight line unless acted on by an external force, consider what is required to make an airplane turn. If a pilot wants to change the course of an airplane in flight, a force perpendicular to the flight path in the direction of the desired turn must first be generated. Usually this is accomplished by banking the airplane. This points the lift vector off to the side, generating a horizontal component of lift (Fig. 32). This is not

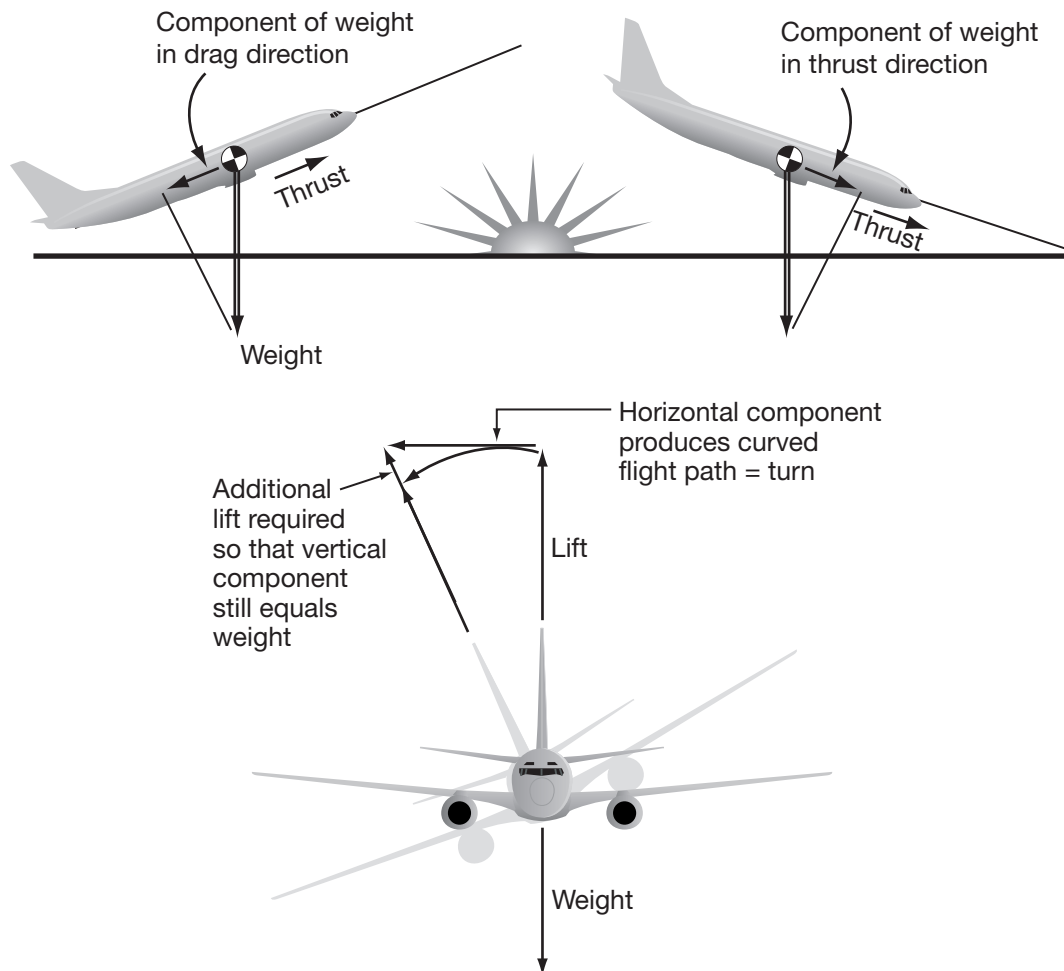

Figure 31  
Contributions of  
Weight Vector

Figure 32  
Mechanics of  
Turning Flight

the only way to generate a sideways-pointing force, but it is the typical method.

When the lift vector is tilted to generate the horizontal component, the vertical component gets smaller. Since the acceleration due to gravity still points toward the Earth, there is now an imbalance in the vertical forces. Unless the lift vector is increased so that its vertical component equals the weight of the airplane, the airplane will begin to accelerate toward the Earth—it will begin to descend. To maintain altitude in a banked turn, the lift produced by the airplane must be more than the weight of the airplane, and the amount is a function of bank angle (Fig. 33).

All of this is well known, but it bears reiteration in the context of recovery from extreme airplane upsets. If the objective is to arrest a descent, maneuvering in pitch if the wings are not level will only cause a tighter turn and, depending on the bank angle, may not contribute significantly to generating a lift vector that points away from the ground. Indeed, Figure 35 indicates that to maintain level flight at bank angles beyond 66 deg requires a larger load factor than that for which transport airplanes are certificated.

In early training, many pilots are warned about the “Graveyard Spiral.” The Graveyard Spiral maneuver is one in which the airplane is in a large bank angle and descending. The unknowing pilot fixates on the fact that airspeed is high and the airplane is descending. In an attempt to arrest both the speed and sinkrate, the pilot pulls on the column and applies up-elevator. However, at a large bank angle, the only effect of the up-elevator is to further tighten the turn. It is imperative to get the wings close to level before beginning any aggressive pitching

maneuver. This orients the lift vector away from the gravity vector so that the forces acting on the airplane can be managed in a controlled way.

Knowledge of these relationships is useful in other situations as well. In the event that the load factor is increasing, excess lift is being generated, and the pilot does not want speed to decrease, bank angle can help to keep the flight path vector below the horizon, getting gravity to help prevent loss of airspeed. In this situation, the excess lift can be oriented toward the horizon and, in fact, modulated up and down to maintain airspeed.

### 2.5.5.8 Lateral Maneuvering

Motion about the longitudinal axis (Fig. 34) is called “roll.” Modern jet transport airplanes use combinations of aileron and spoiler deflections as primary surfaces to generate rolling motion. These deflections are controlled by the stick or wheel, and they are designed to provide precise maneuvering capability. On modern jet airplanes, the specific deflection combinations of ailerons and spoilers, with yaw dampers and turn coordinators, are usually designed to make adverse yaw undetectable to the pilot; hence, the use of rudder is virtually eliminated during normal roll control. Supplementing normal roll control with rudder may induce uncoordinated turning moments, because the pilot inputs will be in addition to the aircraft system inputs, therefore, pilot rudder pedal inputs to augment turn coordination functions (if available) are not recommended.

As described in Section 2.5.5, “Aerodynamics,” trailing edge control surfaces lose effectiveness in the downgoing direction at high angles of attack. Similarly, spoilers begin to lose effectiveness as the stall angle of attack is exceeded.

*Figure 33  
Bank Versus Load  
Factor (g's) for  
Level Flight*

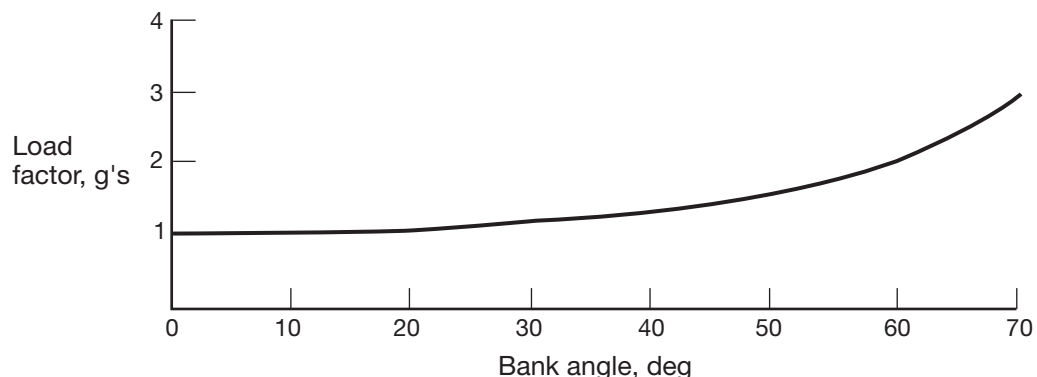

Transport airplanes are certificated to have positive unreversed lateral control up to a full aerodynamic stall. That is, during certification testing, the airplane has been shown to have the capability of producing and correcting roll up to the time the airplane is stalled. However, beyond the stall angle of attack, no generalizations can be made. ***For this reason it is critical to reduce the angle of attack at the first indication of stall so that control surface effectiveness is preserved.***

The apparent effectiveness of lateral control, that is, the time between the pilot input and when the airplane responds, is in part a function of the airplane's inertia about its longitudinal axis. Airplanes with very long wings, and, in particular, airplanes with engines distributed outboard along the wings, tend to have very much larger inertias than airplanes with engines located on the fuselage. This also applies to airplanes in which fuel is distributed along the wing span. Early in a flight with full wing (or tip) tanks, the moment of inertia about the longitudinal axis will be much larger than when those tanks are nearly empty. This greater inertia must be overcome by the rolling moment to produce a roll acceleration and resulting roll angle, and the effect is a "sluggish" initial response. As discussed before, airplanes of large mass and large inertia require that pilots be prepared for this longer response time and plan appropriately in maneuvering.

From a flight dynamics point of view, the greatest power of lateral control in maneuvering the airplane—in using available energy to maneuver the flight path—is to orient the lift vector. In particular, pilots need to be aware of their ability to orient the lift vector with respect to the gravity vector. Upright with wings level, the lift vector is opposed to the gravity vector, and vertical flight path is controlled by longitudinal control and thrust. Upright with

wings not level, the lift vector is not aligned with gravity, and the flight path will be curved. In addition, if load factor is not increased beyond 1.0, that is, if lift on the wings is not greater than weight, the vertical flight path will become curved in the downward direction, and the airplane will begin to descend. Hypothetically, with the airplane inverted, lift and gravity point in the same direction: down. The vertical flight path will become curved and the airplane will accelerate toward the earth quite rapidly. In this case, the pilot must find a way to orient the lift vector away from gravity. In all cases, the pilot should ensure that the angle of attack is below the stall angle and roll to upright as rapidly as possible.

### 2.5.5.9 Directional Maneuvering

Motion about the vertical axis is called "yaw" (Fig. 35). The character of the motion about the vertical axis is determined by the balance of moments about the axis (around the center of gravity). The principal controller of aerodynamic moments about the vertical axis is the rudder, but it is not the only one. Moments about the vertical axis can be generated or affected by asymmetric thrust, or by asymmetric drag (generated by ailerons, spoilers, asymmetric flaps, and the like). These asymmetric moments may be desired (designed in) or undesired (perhaps the result of some failure).

Generally, the rudder is used to control yaw in a way that minimizes the angle of sideslip, that is, the angle between the airplane's longitudinal axis and the relative wind. For example, when an engine fails on takeoff, the object is to keep the airplane aligned with the runway by using rudder.

On modern jet transports with powerful engines located away from the centerline, an engine failure

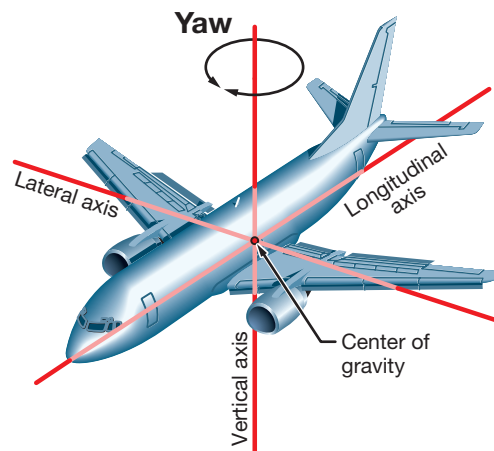
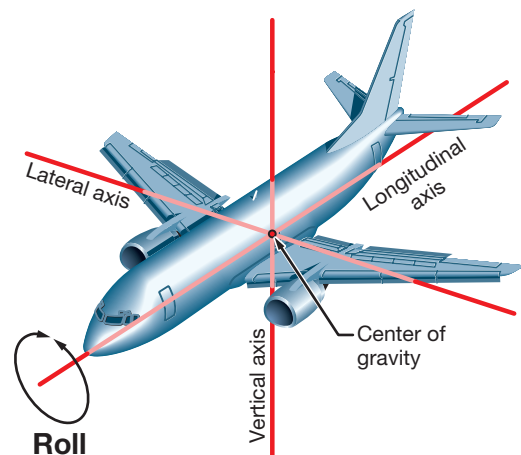

Figure 34  
(Left)  
Roll Axis

Figure 35  
Yaw Axis

can result in very large yawing moments, and rudders are generally sized to be able to control those moments down to very low speeds. This means that the rudder is very powerful and has the capability to generate very large yawing moments. ***When the rest of the airplane is symmetric, for example, in a condition of no engine failure, very large yawing moments would result in very large sideslip angles and large structural loads should the pilot input full rudder when it is not needed.*** Pilots need to be aware of just how powerful the rudder is and the effect it can have when the rest of the airplane is symmetric.

Many modern airplanes limit the rudder authority in parts of the flight envelope in which large deflections are not required, for example, at high speeds. In this way, the supporting structure can be made lighter. Pilots also need to be aware of such “rudder limiting” systems and how they operate on airplanes. The implementation of the rudder limiting function and associated forces varies from model to model and between manufacturers. The force a pilot feels when pushing on the rudder pedals is analogous to that of a force generated by a spring. The more the pedal is displaced the greater the required force. All modern transport airplanes limit rudder deflection as airspeed increases. Engine out takeoff and crosswind landing requirements define the maximum rudder deflection (authority). As the airplane flies faster, less deflection is needed and rudder authority is therefore reduced.

Some airplanes have rudder limiters that reduce the rudder authority by changing the gearing between the rudder and the rudder pedals. As the airplane

speeds up, the pilot must continue to fully deflect the rudder pedal to command full available rudder, even though the maximum available rudder deflection has been reduced. This means the pilot will have to apply the same force to the rudder pedal to achieve maximum *available* rudder deflection throughout the flight envelope. Figure 36a shows an example of this type of system.

On other models, as the airplane speeds up, the rudder authority is limited, but the gearing between the rudder and the rudder pedal does not change. Since rudder authority is limited, rudder pedal travel is also limited (i.e., full rudder pedal deflection is not required to get full available rudder deflection). Rudder pedal force is a function of rudder pedal deflection, so less force will be required to achieve maximum available rudder deflection as airspeed increases (Fig. 36b)

Airplanes do vary on the amount of rudder pedal force and displacement required to achieve maximum available rudder as airspeed changes. It is important that pilots understand their airplane’s feel and response characteristics to flight control inputs. By understanding and becoming familiar with the airplane’s characteristics, pilots will learn to apply the appropriate control input in response to various flight situations.

From a structural capability standpoint, the pilot does not have to be concerned about how fast or how hard to push the rudder pedal in one direction (from zero to full available pedal deflection) throughout the normal flight envelope. However, it is important to emphasize that limiters do not

**Figure 36a**  
**Example 1:**  
**Rudder Deflection**  
**and Force**  
**Requirements**

V <sub>1</sub>			250kts			FL390 MMO		
Pedal force, lb	Pedal travel, in	Rudder deflection, deg	Pedal force, lb	Pedal travel, in	Rudder deflection, deg	Pedal force, lb	Pedal travel, in	Rudder deflection, deg
50	2.5	30	50	2.5	10	50	2.5	5

**Figure 36b**  
**Example 2:**  
**Rudder Deflection**  
**and Force**  
**Requirements**

V <sub>1</sub>			250kts			FL390 MMO		
Pedal force, lb	Pedal travel, in	Rudder deflection, deg	Pedal force, lb	Pedal travel, in	Rudder deflection, deg	Pedal force, lb	Pedal travel, in	Rudder deflection, deg
50	2.5	30	30	1.5	10	25	1.0	5

protect against the structural loads or excessive sideslip angles that can be generated from rapid full deflection flight control reversals.

There are a few cases, however, when it is necessary to generate sideslip. One of the most common is the crosswind landing. In the slip-to-a-landing technique, simultaneous use of rudder and aileron/spoiler aligns the airplane with the runway centerline and at the same time keeps the airplane from drifting downwind. The airplane is flying “sideways” and the pilot feels the lateral acceleration.

Static directional stability is a measure of the tendency of an airplane to weathervane into the free stream airmass. The vertical fin and distribution of flat plate area aft of the CG tend to reduce sideslip and add to good directional stability. All conventional airplanes require positive static directional stability. In simple terms, an airplane with good directional stability always wants to point directly into the relative wind—zero sideslip. As directional stability increases, the speed at which the aircraft returns to zero sideslip after being disturbed increases (higher frequency). In order to minimize overshoots in sideslip, the damping in the directional axis must be increased as the directional stability is increased. An undesirable characteristic can develop when the directional damping is not adequate enough to prevent overshoots in sideslip. A phenomenon known as “Dutch roll” (based on the similarity with the motions of high-speed ice skaters) can occur. A Dutch roll occurs when yaw rates produce sideslips, which produce roll rates. If the sideslips are not adequately damped, the aircraft nose will swing back and forth with respect to the relative wind, and the aircraft will roll right and left due to the dihedral effect (the wingsweep results in asymmetric lift, depending on the relative wind). Airplanes designed to fly at higher Mach numbers have more wingsweep to control the critical Mach number (the speed at which shock waves begin to form on the wing). As wingsweep increases, the dihedral effect increases, and if the airplane is not adequately damped in the directional axis, a Dutch roll might occur if the airplane is upset directionally. Yaw dampers were designed to minimize yaw rates, which result in sideslip rates, and are very effective in modern transports in damping the Dutch roll. However, some transport airplanes have a neutral or slightly divergent Dutch roll if the yaw damper is off or inoperative. Conventional airplanes exhibit more of a Dutch roll tendency at

higher altitude (less damping) and higher speed (more directional stability). Therefore, if a pilot encounters a Dutch roll condition, every effort should be made to “slow down and go down.” With a properly functioning yaw damper, Dutch rolls will not occur in modern transport aircraft. Transport airplanes are certificated to demonstrate positively damped Dutch roll oscillations. The rudder should not be used to complement the yaw damper system. If the yaw damper system is inoperative, the rudder should not be used to dampen Dutch roll. Refer to your aircraft’s non-normal section for procedures to deal with yaw damper failure.

The installed systems that can drive the rudder surface are typically designed in a hierarchical manner. For example, the yaw damper typically has authority to move the rudder in only a limited deflection range. Rudder trim, selectable by the pilot, has authority to command much larger rudder deflections that may be needed for engine failure. In most cases, the pilot, with manual control over rudder deflection, is the most powerful element in the system. The pilot can command deflection to the limits of the system, which may be surface stops, actuator force limits, or any others that may be installed (e.g., rudder ratio changers).

Precise roll control using rudder is difficult and therefore not recommended. The use of up to full rudder for control of engine failures and crosswind takeoffs and landings is what the system was designed to do. Airplanes do vary on the amount of rudder pedal force and displacement required to achieve maximum available rudder as airspeed changes. It is important that pilots understand their airplane’s feel and response characteristics to flight control inputs. By understanding and becoming familiar with the airplane’s response characteristics, pilots will learn to apply the appropriate control input in response to various flight situations. Transport pilots should be aware that certain prior experience or training in military, GA, or other nontransport aircraft that emphasizes use of rudder input as a means to maneuver in roll typically does not apply to transport aircraft or operations. When normal means of roll control have been unsuccessful, careful rudder input in the direction of the desired roll should be considered to induce or augment a rolling maneuver or to provide the desired bank angle. A rudder input is never the preferred initial response for events such as a wake vortex encounter or windshear encounter, or to reduce the bank angle preceding an imminent stall recovery.

#### 2.5.5.10 Flight at Extremely Low Airspeeds

Stall speed is discussed in Section 2.5.5.1. It is possible for the airplane to be flown at speeds below the defined stall speed. This regime is outside the certified flight envelope. At extremely low airspeeds, there are several important effects for the pilot to know.

Recall from the discussion of aerodynamics that the aerodynamic lift that is generated by wings and tails depends on both the angle of attack and the velocity of the air moving over the surfaces. Angle of attack alone determines whether the surface is stalled. At very low airspeeds, even far below the strictly defined stall speed, an unstalled surface (one at a low angle of attack) will produce lift. However, the magnitude of the lift force will probably be very small. For a surface in this condition, the lift generated will not be enough to support the weight of the airplane. In the case of the lift generated by the tail, at very low airspeeds, it may not be great enough to trim the airplane, that is, to keep it from pitching.

With small aerodynamic forces acting on the airplane, and gravity still pulling towards the earth, the trajectory will be largely ballistic. It may be difficult to command a change in attitude until gravity produces enough airspeed to generate sufficient lift—and that is only possible at angles of attack below the stall angle. For this reason, if airspeed is decreasing rapidly it is very important to reduce angle of attack and use whatever aerodynamic forces are available to orient the airplane so that a recovery may be made when sufficient forces are available.

When thrust is considered, the situation becomes only slightly more complicated. With engines offset from the center of gravity, thrust produces both forces and moments. In fact, as airspeed decreases, engine thrust generally increases for a given throttle setting. With engines below the center of gravity, there will be a noseup moment generated by engine thrust. Especially at high power settings, this may contribute to even higher noseup attitudes and even lower airspeeds. Pilots should be aware that as aerodynamic control effectiveness diminishes with lower airspeeds, the forces and moments available from thrust become more evident, and until the aerodynamic control surfaces become effective, the trajectory will depend largely on inertia and thrust effects.

#### 2.5.5.11 High-Altitude Characteristics

Modern commercial jet transport airplanes are designed to fly at altitudes from sea level to more than 40,000 ft. There are considerable changes in atmospheric characteristics that take place over that altitude range, and the airplane must accommodate those changes.

As a purely practical matter, it is useful to identify high altitude operations as those above flight level 250 (FL250 or 25,000 ft). The great majority of passengers and freight is now being carried in turbojet-powered airplanes, virtually all of which regularly operate at altitudes above FL250 where high speeds and best economy are attained. While aerodynamic principles and certain hazards apply at all altitudes, they become particularly significant with respect to loss of control (or upset) at altitudes above FL250. For these reasons and others, this training aid defines high altitude as any altitude above FL250.

One item of interest to pilots is the air temperature as altitude changes. Up to the tropopause (36,089 ft in a standard atmosphere), the standard temperature decreases with altitude. Above the tropopause, the standard temperature remains relatively constant. This is important to pilots because the speed of sound in air is a function only of air temperature. Aerodynamic characteristics of lifting surfaces and entire airplanes are significantly affected by the ratio of the airspeed to the speed of sound. That ratio is represented as a Mach number. At high altitudes, large Mach numbers exist at relatively low calibrated airspeeds.

Pilots need to be aware of the Mach number and altitude effects on the stability and handling qualities of their airplanes. Many pilots know that maneuvering an airplane at traffic pattern altitudes “feels” different than maneuvering at the same calibrated airspeed at cruise altitude. As mentioned above, altitude and Mach number change the aerodynamic characteristics of the airplane – so it does “feel” and respond differently. As altitude increases (in a standard atmospheric model), air density decreases. When this occurs, natural aerodynamic damping decreases and the airplane becomes more responsive to control inputs. Higher Mach numbers may also adversely affect the stability of the airplane, causing undesirable characteristics to develop or worsen.

As Mach number increases, airflow over parts of the airplane begins to exceed the speed of sound. Shock waves associated with this local supersonic flow can interfere with the normally smooth flow over the lifting surfaces, causing local flow separation. Depending on the airplane, as this separation grows in magnitude with increasing Mach number, characteristics such as pitchup, pitchdown, or aerodynamic buffeting may occur. Transport category airplanes are certificated to be free from characteristics that would interfere with normal piloting in the normal flight envelope and to be safely controllable during inadvertent exceedances of the normal envelope, as discussed in Section 2.5.4, "Aerodynamic Flight Envelope."

The point at which buffeting would be expected to occur is documented in the AFM. The Buffet Boundary or Cruise Maneuver Capability charts contain a wealth of information about the high-altitude characteristics of each airplane. A sample of such a chart is shown in Figure 37.

The chart provides speed margins to low-speed (stall-induced) and high-speed (shock-induced) buffet at 1 g, normal load factor or bank angle

to buffet at a given Mach number, or altitude capability at a given Mach number and 1 g. The buffet boundaries of various airplanes can differ significantly in their shapes, and these differences contain valuable information for the pilot. Some airplanes have broad speed margins; some have abrupt high-speed buffet margins; some have narrow, "peaky" characteristics, as depicted notionally in Figure 38. Pilots should become familiar with the buffet boundaries. These boundaries let the pilot know how much maneuvering room is available, and they give clues for successful strategies should speed changes become rapid or attitude or flight path angles become large.

For example, the pilot of Airplane A in the figure has a broad speed range between high- and low-speed buffet onset at 1 g and the current altitude, with only a nominal g capability. Airplane B has by comparison a much smaller speed range between high- and low-speed buffet onset, but a generous g capability at the current Mach number. Airplane C is cruising much closer to the high-speed buffet boundary than the low-speed boundary, which lets the pilot know in which direction (slower) there is more margin available.

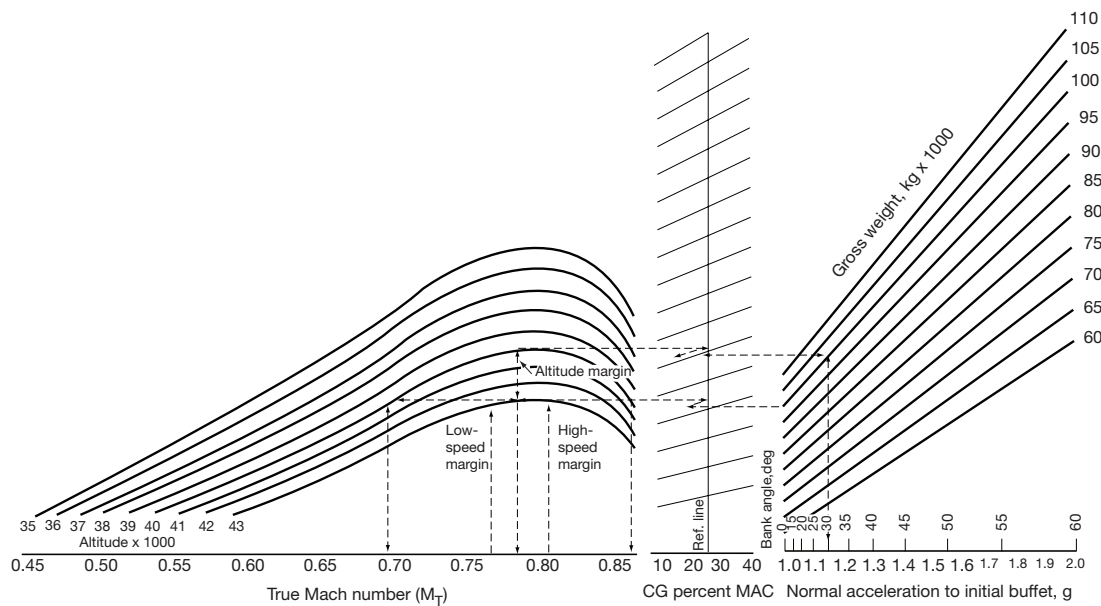

Figure 37  
Sample Buffet  
Boundary Chart

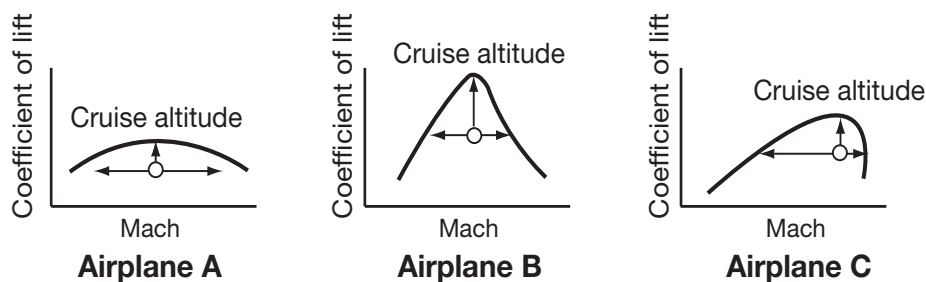

Figure 38  
Notional Buffet  
Boundaries



### 2.5.5.11.1 Regulatory Issues

The high altitude environment has a number of specific references within regulations. These references include: criteria defining maximum operating altitude and service ceilings, required high altitude training, flight crew member use of oxygen, passenger briefings, airspace issues, transponder usage, and Reduced Vertical Separation Minimum (RVSM) requirements. Although these provide necessary knowledge for flight crews, this document will focus on the information needed to prevent and recover from upsets in the high altitude environment.

### 2.5.5.11.2 Aerodynamic Principles of High Altitude Operations

There are a number of aerodynamic principles that are necessary to understand to have a good grasp of high altitude performance.

#### 2.5.5.11.2.1 L/D Max

The lowest point on the total drag curve (as indicated in Fig. 39) is known as L/D max (or  $V_{md}$ -minimum drag speed). The speed range slower than L/D max is known as slow flight, which is sometimes referred to as the “back side of the power-drag curve” or the “region of reverse command.” Speed faster than L/D max is considered normal flight, or the “front side of the power-drag curve.”

Normal flight (faster than L/D max) is inherently stable with respect to speed. When operating in level flight at a constant airspeed with constant thrust setting, any airspeed disturbance (such as turbulence) will result in the airspeed eventually returning to the original airspeed when the total thrust has not changed.

Slow flight (slower than L/D max) is inherently unstable with respect to speed and thrust settings. When operating at a constant airspeed with constant thrust setting, any disturbance causing a decrease in airspeed will result in a further decrease in airspeed unless thrust is increased. As shown in Figure 39, the lower speed will subject the airplane to increased drag. This increase in drag will cause a further decrease in airspeed, which may ultimately result in a stalled flight condition. Flight slower than L/D max at high altitudes must be avoided due to the inefficiency and inherent instability of the slow flight speed range. When operating slower than L/D max, and where total drag exceeds total thrust, the airplane will be unable to maintain altitude and the only remaining option to exit the slow flight regime is to initiate a descent.

External factors, such as changing winds, increased drag in turns, turbulence, icing, or internal factors, such as anti-ice use, auto-throttle rollback, or engine malfunction or failure can cause airspeed decay. Heavily damped auto-throttles, designed for passenger comfort, may not apply thrust aggressively enough to prevent a slowdown below L/D max.

Slower cruising speeds are an issue. As airplanes are pushed to more efficient flight profiles to save fuel, it may dictate high altitude cruising at lower Mach numbers. The net result is the crew may have less time to recognize and respond to speed deterioration at high altitude.

At all times, pilots must ensure that flight slower than L/D max is avoided in the high altitude environment. Proper flight planning and adherence to published climb profiles and cruise speeds will ensure that speeds slower than L/D max are avoided.

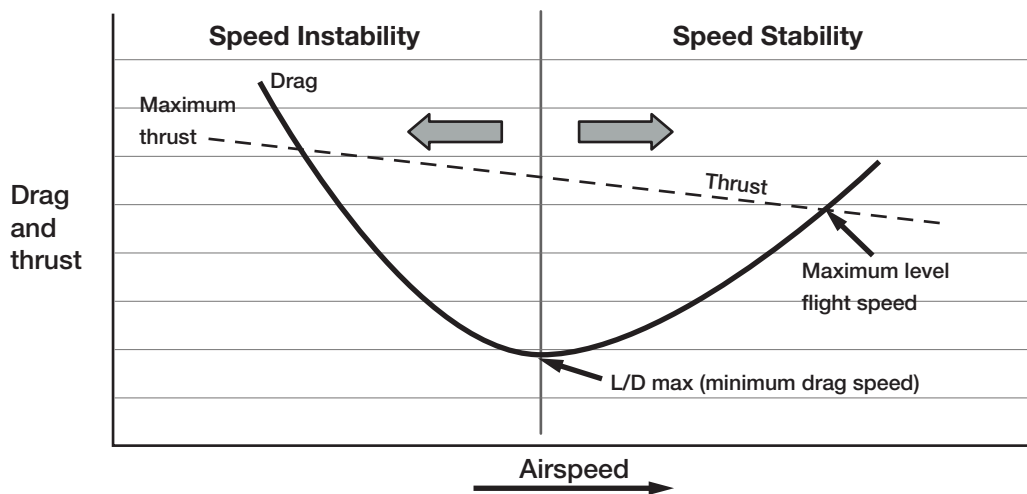

Figure 39  
Airspeed Versus Drag  
in Level Flight

As an airplane climbs and cruises at high altitude, flight crews should be aware of terms that affect them.

#### 2.5.5.11.2.2 Crossover Altitude

Crossover Altitude is the altitude at which a specified CAS (Calibrated airspeed) and Mach value represent the same TAS (True airspeed) value. Above this altitude the Mach number is used to reference speeds.

#### 2.5.5.11.2.3 Optimum Altitude

Optimum Altitude is defined as an altitude at which the equivalent airspeed for a thrust setting will equal the square root of the coefficient of lift over the coefficient of drag. In less technical terms, it is the best cruise altitude for a given weight and air temperature. A dramatic increase in temperature will change the optimum altitude. Therefore, when flying at optimum altitude, temperature must be monitored to ensure performance capability.

#### 2.5.5.11.2.4 Optimum Climb Speed Deviations

Airplane manuals and flight management systems produce optimum climb speed charts and speeds. When increased rates of climb are required, ensure speed is not decreased below L/D max. Evidence shows that inappropriate use of vertical speed modes is involved in the majority of slow speed events during high altitude climbs.

#### 2.5.5.11.2.5 Thrust Limited Condition and Recovery

Most jet transport airplanes are thrust limited, rather than low speed buffet limited, at altitude, especially in a turn. It is imperative that crews be aware of outside temperature and thrust available. To avoid losing airspeed due to a thrust limit, use flight management systems/reduced bank angle as a routine for en-route flight if it incorporates real-time bank angle protection, or routinely select a bank angle limit of 10-15 degrees for cruise flight. If a condition of airspeed decay occurs at altitude, take immediate action to recover:

- Reduce bank angle
- Increase thrust – select maximum continuous thrust if the airplane’s auto-throttle system is maintaining thrust at a lower limit
- Descend

If a high drag situation occurs where maximum available thrust will not arrest the airspeed decay,

the only available option is to descend.

#### 2.5.5.11.2.6 Maximum Altitude

Maximum altitude is the highest altitude at which an airplane can be operated. In today’s modern airplanes it is determined by three basic characteristics which are unique to each airplane model. It is the lowest of:

- Maximum certified altitude (structural) that is determined during certification and is usually set by the pressurization load limits on the fuselage.
- Thrust Limited Altitude – the altitude at which sufficient thrust is available to provide a specific minimum rate of climb.
- Buffet or Maneuver limited altitude – the altitude at which a specific maneuver margin exists prior to buffet onset.

Although each of these limits is checked by modern flight management computers, the available thrust may limit the ability to accomplish anything other than relatively minor maneuvering.

The danger in operating near these ceilings is the potential for the speed and angle of attack to change due to turbulence or environmental factors that could lead to a slowdown or stall and subsequent high altitude upset.

In early turbojet era airplanes, the capability to reach what is called absolute ceiling or “coffin corner” could exist. This is where, if an airplane flew any slower, it would exceed its stalling angle of attack and experience low speed buffet. Additionally, if it flew any faster, it would exceed Mmo, potentially leading to high speed buffet.

All airplanes are equipped with some form of stall warning system. Crews must be aware of systems installed on their airplanes (stick pushers, shakers, audio alarms, etc.) and their intended function. In a high altitude environment, airplane buffet is sometimes the initial indicator of problems.

#### 2.5.5.11.2.7 Maneuvering Stability

For the same control surface movement at constant airspeed, an airplane at 35,000 ft experiences a higher pitch rate than an airplane at 5,000 ft because there is less aerodynamic damping. Therefore, the change in angle of attack is greater, creating more lift and a higher load factor. If the control system is designed to provide a fixed ratio of control force to elevator deflection, it will take less force to generate

the same load factor as altitude increases.

An additional effect is that, for a given attitude change, the change in rate of climb is proportional to the true airspeed. Thus, for an attitude change for 500 ft per minute (fpm) at 290 knots indicated air speed (KIAS) at sea level, the same change in attitude at 290 KIAS (490 knots true air speed) at 35,000 ft would be almost 900 fpm. This characteristic is essentially true for small attitude changes, such as the kind used to hold altitude. It is also why smooth and small control inputs are required at high altitude, particularly when disconnecting the autopilot.

Operating limits of modern transport category airplanes are designed so that operations within these limits will be free of adverse handling characteristics. Exceeding these limits can occur for various reasons and all modern transport airplanes are tested to allow normal piloting skill to recover these temporary exceedences back to the normal operational envelope. It is imperative to not overreact with large and drastic inputs. There is no need to take quick drastic action or immediately disconnect a correctly functioning autopilot. Pilots should smoothly adjust pitch and/or power to reduce speed should an overspeed occur.

In the high altitude flight area there is normally adequate maneuver margin at optimum altitude. Maneuver margin decreases significantly as the

pilot approaches maximum altitude. Flying near maximum altitude will result in reduced bank angle capability; therefore, autopilot or crew inputs must be kept below buffet thresholds. The use of LNAV will ensure bank angle is limited to respect buffet and thrust margins. The use of other automation modes, or hand flying, may cause a bank angle that results in buffeting. When maneuvering at or near maximum altitude there may be insufficient thrust to maintain altitude and airspeed. The airplane may initially be within the buffet limits but does not have sufficient thrust to maintain the necessary airspeed. This is a common item in many high altitude situations where airplanes slow down to the lower buffet limits. These situations can be illustrated with performance charts.

Figure 40 shows a typical transport category airplane optimum and maximum altitude capability. When temperature increases, the maximum altitude capability decreases significantly. This is a situation where maneuver buffet margins are adequate but temperature is affecting thrust capability to sustain airspeed at the higher altitudes.

Figure 41 shows that for normal cruise speeds there is excess thrust available at this fixed weight and altitude. When trying to turn using 30 degrees of bank, the drag exceeds the normal maximum cruise thrust limit. If the pilot selects maximum continuous thrust (MCT) then there is enough thrust to maintain the bank angle in the same situation.

*Figure 40  
Typical Optimum  
Versus Maximum  
Altitude*

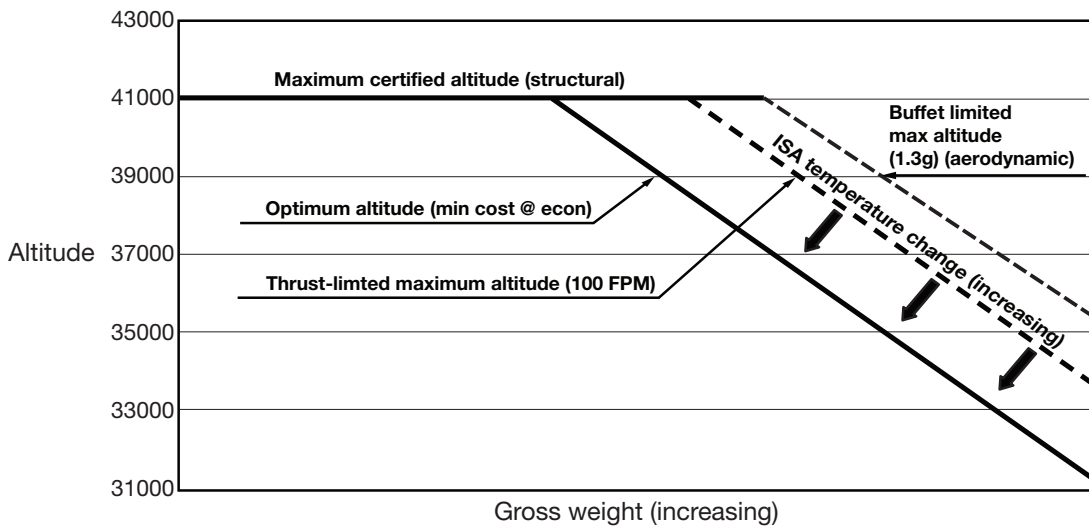

Note: as ISA temperature increases - altitude capability is reduced

### 2.5.5.11.3 Weight & Balance Effects on Handling Characteristics

Weight and Balance limitations must be respected. An airplane that is loaded outside the weight and balance envelope will not exhibit the expected level of stability and will result in aircraft handling that is unpredictable and may not meet certification requirements. This is a serious issue, particularly in an aft loading situation where stall recovery may be severely affected. The problem may be exacerbated at high altitude.

At high altitude, an aft loaded airplane will be more responsive to control pressures since it is less stable than a forward loading. Of interest to pilots is that the further aft an airplane is loaded, less effort is required by the tail to counteract the nose down pitching moment of the wing. The less effort required by the tail results in less induced drag on the entire airplane which results in the most efficient flight. Some airline load planning computers attempt to load airplanes as far aft as possible to achieve efficiency. Some advanced airplanes use electronic controls to help improve airplane handling with aft loading.

### 2.5.5.11.4 Mach Tuck and Mach Buffet

In some airplanes, at speeds above  $M_{mo}$ , a phenomenon called mach tuck will occur. Above critical Mach number, the speed of an airplane at which airflow over any part of the wing first reaches Mach 1.0, a shock wave will begin to form on the wing and mach buffet will occur. Mach buffet

will continue to increase with increased speed and the aft movement of the shock wave, the wing's center of pressure also moves aft causing the start of a nose-down tendency or "tuck." Because of the changing center of lift of the wing resulting from the movement of the shock wave, the pilot will experience pitch down tendencies. In modern transport airplanes this phenomenon has been largely eliminated.

### 2.5.5.11.5 Buffet-Limited Maximum Altitude

There are two kinds of buffet to consider in flight: low speed buffet and high speed buffet. As altitude increases, the indicated airspeed at which low speed buffet occurs increases. As altitude increases, high speed buffet speed decreases. Therefore, at a given weight, as altitude increases, the margin between high speed and low speed buffet decreases.

Proper use of buffet boundary charts or maneuver capability charts can allow the crew to determine the maximum altitude that can be flown while still respecting the required buffet margins.

At high altitudes the excess thrust available is limited. Crews must be aware that additional thrust is available by selecting maximum available/continuous thrust at any time. However, in extreme airspeed decay situations MCT may be insufficient. Proper descent techniques will be necessary in order to prevent further airspeed decay into an approach to stall and stall situation.

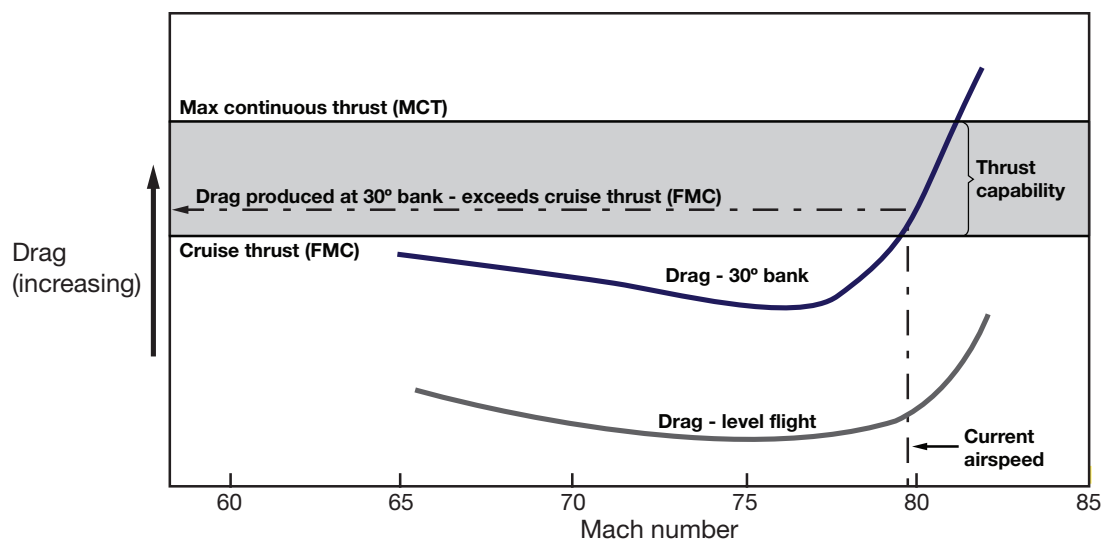

Figure 41  
Drag Induced  
by Bank Versus  
Available Thrust

### 2.5.5.11.6 Stalls

Fundamental to understanding angle of attack and stalls is the realization that an airplane wing can be stalled at any airspeed and any altitude. Moreover, attitude has no relationship to the aerodynamic stall. Even if the airplane is in descent with what appears to be ample airspeed, the surface can be stalled. If the angle of attack is greater than the stall angle, the surface will stall.

Most pilots are experienced in simulator or even airplane exercises that involve approach to stall. This is a dramatically different condition than a recovery from an actual stall because the technique is not the same. The present approach to stall technique being taught for testing is focused on “powering” out of the near-stalled condition with emphasis on minimum loss of altitude. At high altitude this technique may be totally inadequate due to the lack of excess thrust. It is impossible to recover from a stalled condition without reducing the angle of attack and that will certainly result in a loss of altitude, regardless of how close the airplane is to the ground. Although the thrust vector may supplement the recovery, it is not the primary control. At stall angles of attack, the drag is very high and thrust available may be marginal. Also, if the engine(s) are at idle, the acceleration could be very slow, thus extending the recovery. At high altitudes, where the available thrust is reduced, it is even less of a benefit to the pilot. The elevator is the primary control to recover from a stalled condition because, without reducing the angle of attack, the airplane will remain in a stalled condition until ground impact, regardless of the altitude at which it started.

Effective stall recovery requires a deliberate and smooth reduction in wing angle of attack. The elevator is the primary pitch control in all flight conditions, not thrust.

Although stall angle of attack is normally constant for a given configuration, at high altitudes swept wing turbojet airplanes may stall at a reduced angle of attack due to Mach effects. The pitch attitude will also be significantly lower than what is experienced at lower altitudes. Low speed buffet will likely precede an impending stall. Thrust available to supplement the recovery will be dramatically reduced and the pitch control through elevator must be used. The goal of minimizing altitude loss must be secondary to recovering from the stall. Flight crews must exchange altitude for energy. Only after positive stall recovery has been achieved, can altitude recovery be prioritized.

At high altitudes the upper air currents such as the jet-stream become significant. Velocities in the jet-stream can be very high and can present a beneficial tailwind or a troublesome headwind. Windshear at the boundaries of the jet-stream can cause severe turbulence and unexpected changes in airspeed or Mach number. This windshear, or other local disturbances, can cause substantial and immediate airspeed decreases in cruise, as well as climb situations. If the airplane is performance limited due to high altitude and subsequently encounters an area of decreasing velocity due to wind shear, in severe cases the back side of the power curve may be encountered. The pilot will have to either increase thrust or decrease angle of attack to allow the airspeed to build back to normal climb/cruise speeds. This may require trading altitude for airspeed to accelerate out of the backside of the power curve region if additional thrust is not available.

### 2.5.5.11.7 Icing

Pilots must understand that occasionally icing does occur at high altitudes and they must be prepared to use anti-ice. Careful monitoring of flight conditions is critical in this decision making.

Appropriate and judicious use of anti-ice equipment at high altitude is very important. One must be aware of the fact that the use of anti-ice has a negative effect on the available thrust. In some cases, it may not be possible to maintain cruise speed or cruise altitude at high altitude with anti-ice on. Pilots should also be aware of the specific flight planning parameters for their particular flight.

In-flight icing is a serious hazard. It destroys the smooth flow of air on the airplane, increasing drag, degrading control authority and decreasing the ability of an airfoil to produce lift. The airplane may stall at much higher speeds and lower angles of attack than normal. If stalled, the airplane can roll or pitch uncontrollably, leading to an in-flight upset situation.

Even with normal ice protection systems operating properly, ice accretion on unprotected areas of the airplane may significantly increase airplane weight and drag.

Activation of an artificial stall warning device, such as a stick shaker, is typically based on a pre-set angle of attack. This setting gives a warning prior to actual stall onset where buffeting or shaking of the airplane

occurs. For a clean airplane, the pilot has adequate warning of impending stall. However, with ice, an airplane may exhibit stall onset characteristics before stick shaker activation because of the effect of ice formations on reducing the stall angle-of-attack. In this case, the pilot does not have the benefit of a stick shaker or other stall warning

Flight crews must be especially wary of automation during icing encounters. Autopilots and auto-throttles can mask the effects of airframe icing and this can contribute to ultimate loss of control. There have been several accidents in which the autopilot trimmed the airplane right to a stall upset situation by masking heavy control forces. If the autopilot disengages while holding a large roll command to compensate for an asymmetrical icing condition (or other similar problem causing roll), an immediate large rolling moment ensues for which the pilot may not be prepared, resulting in a roll upset. Pilots have been surprised when the autopilot automatically disconnected with the airplane on the brink of a stall.

Some autopilots are designed with control laws that enable them to continue to operate until they get to stick shaker. Alternatively, the autopilot may disconnect early because of excessive roll rates, roll angles, control surface deflection rates, or forces that are not normal. These autopilots are not malfunctioning; they are working as designed.

High altitude weather can cause favorable conditions for upsets. Thunderstorms, clear air turbulence, and icing are examples of significant weather that pilots should take into consideration in flight planning. Careful review of forecasts, significant weather charts, and turbulence plots are key elements in avoiding conditions that could lead to an upset.

Once established in cruise flight, the prudent crew will update weather information for the destination and enroute. By comparing the updated information to the preflight briefing, the crew can more accurately determine if the forecast charts are accurate. Areas of expected turbulence should be carefully plotted and avoided if reports of severe turbulence are received. Trend monitoring of turbulence areas is also important. Trends of increasing turbulence should be noted and if possible avoided. Avoiding areas of potential turbulence will reduce the risk of an upset.

#### **2.5.5.11.8 Primary Flight Display Airspeed Indications**

Modern airplanes that are equipped with a primary flight display (PFD) provide information that will help maintain a safe airspeed margin between the low and high speed limits. Most of these airplanes have an indication of airspeed trending. This is important because these displays do not indicate that adequate thrust is available at that altitude to maintain the current airspeed. Older airplanes have charts in the performance section that depict adequate speed ranges for a given altitude and weight.

#### **2.5.5.11.9 Automation During High Altitude Flight**

During cruise at high altitude, the autopilot will be engaged with the pitch in an altitude hold mode and the throttles in a speed mode. However, it is possible that, due to changing conditions (increasing temperature, mountain wave, etc.) or poor planning, an airplane could be thrust limited and not be able to maintain the desired altitude and/or airspeed. Regardless, the airplane's automatic control system will try to maintain this altitude by increasing thrust to its selected limit. When the thrust is at the maximum limit, the pitch may continue to increase to maintain altitude and the airspeed then continues to decay. The only option then is to descend. The pilot's action should be to pitch down and increase the airspeed while being in an automation mode that keeps the throttles at maximum thrust. If the autopilot is still engaged, select a lower altitude and use an appropriate mode to start the aircraft down. However, if the aircraft is not responding quickly enough you must take over manually. Pilots must assess the rate at which vertical speed and airspeed increase is occurring to make this determination. This does not imply that aggressive control inputs are necessary. The autopilot can then be reengaged once the aircraft is in a stable descent and the commanded speed has been reestablished. Do not attempt to override the autopilot. It is always better to disconnect it before making manual control inputs. Due to RVSM considerations and large altitude losses, crews should consider turning off course during descents and monitoring TCAS to reduce the potential for collisions. Crews should also inform ATC of their altitude deviation.

The consequences of using Vertical Speed (VS) at high altitude must be clearly understood. Most autoflight systems have the same logic for prioritiz-

ing flight path parameters. The fundamental aspect of energy management is to manage speed by either elevator or with thrust. When using the VS mode of the Auto Flight System (AFS), airplane speed is normally controlled by thrust. If a too high vertical descent rate is selected, the autothrottle will reduce thrust to idle and the airspeed will start to increase above the command speed. The reverse situation can occur with considerable risk if an excessive climb rate is selected. In that case, if the thrust available is less than the thrust required for that selected vertical speed rate the commanded speed will not be able to be held and a speed decay will result. On some airplanes, improper use of VS can result in speed loss and eventually a stall.

Pilots must understand the limits of their airplanes when selecting vertical modes. As a general guideline, VS should not be used for climbing at high altitudes. Reduced thrust available at high altitudes means that speed should be controlled through pitch and not with thrust. VS can be used for descent; however, selecting excessive vertical speeds can result in airspeed increases into an overspeed condition. Using a mode that normally reduces thrust, when the need arises to descend immediately, may not be appropriate for a low speed situation. Either disconnect autothrottles, or use a mode that keeps the throttles at maximum available thrust in these situations.

#### **2.5.5.11.10 Human Factors and High Altitude Upsets**

The flightcrew may be startled by unexpected low airspeed stall warnings, dynamic buffeting, and large changes in airplane attitude (design dependent) especially when the airplane is on autopilot. While flightcrews receive training on systems such as stick shakers to alert the pilots of impending stall, normally they do not receive realistic training in actual full stall recovery, let alone stall recovery at high altitudes. Hence, flight crews are inclined to respond to high altitude stalls like they have been trained to respond to stall warnings, but the procedures for the latter are neither effective nor proper for stall recovery. Furthermore, unlike the conditions for which the flightcrew is trained to respond to stall warnings at lower altitudes, at the higher altitudes the available thrust is insufficient, alone, to recover from a stall. The only effective response is to reduce the angle of attack and trade altitude for airspeed. Pilots have also reported that low airspeed buffet was mistaken for high speed buffet which prompts an incorrect response to

reduce airspeed when approaching a low airspeed stall. As in any emergency situation, if the airplane is designed with effective alerting (actual and/or artificial) and the flightcrew is adequately trained to recognize the indicators of the stall, these will lead to appropriate flight crew recovery actions as discussed in the next paragraph. Equally important is that crews be familiar with stall warning and recognition devices, such as stick pushers, in order to understand their operation.

Once the pilot recognizes the airplane is in a full aerodynamic stall, immediate corrective actions and decisions required for airplane recovery are sometimes delayed by the flightcrew. Some of the reasons for the delay include 1) lack of situational awareness and crew confusion, 2) anxiety associated with altitude violations and maintaining separation from other air traffic, 3) previous training emphasizing prevention of altitude loss of only a few hundred feet even in the case of an impending high altitude stall, 4) inadequate experience with high altitude manual flight control, and 5) concern for passenger and crew safety. While the magnitude of required flight control input will vary by airplane design for recovery, flightcrews should be trained to expect a longer recovery time and greater altitude loss, often thousands of feet, while the airplane accelerates to gain airspeed following high altitude stall.

Also, since there is no detailed checklist or procedure telling the pilot when to start the stall recovery and how much back pressure should be used for return to level flight after stall recovery, these techniques need to be adequately trained. For example, during stall recovery, pilots gauge how assertively they can pull back by using stick shaker activation to indicate when to reduce back pressure. Other pilots may use angle of attack limit indications on the attitude indicator (if equipped) to aid in the stall recovery. Pilots should also be aware that aggressive stall recovery and subsequent altitude recapture can result in a secondary stall during stall recovery as the pilot discovers the correct level of control inputs required to recover the airplane. On the other side there is the concern of accelerating into high speed buffet during the recovery if the airplane is allowed to accelerate too much.

#### **2.5.5.11.11 Additional Considerations**

##### **2.5.5.11.11.1 Multi-Engine Flame Out**

At high altitudes, as a result of very low airspeed, stall conditions, or other occurrences, an all engine

flameout may occur. This is easily detected in cruise but may be more difficult to detect during a descent. The all engine flameout demands prompt action regardless of altitude and airspeed. After recognition, immediate accomplishment of the recall items and/or checklist associated with the loss of all engines is necessary to quickly establish the appropriate airspeed (requires a manual pitch down) and to attempt a windmill relight. It should be noted that loss of thrust at higher altitudes (above 30,000 feet) may require driftdown to a lower altitude to improve windmill starting capability. Additionally, even though the inflight start envelope is provided to identify the region where windmill starts can occur, it is often demonstrated during certification that this envelope does not define the only areas where a windmill start may be successful. Regardless of the conditions and status of the airplane, strict adherence to the checklist is essential to maximize the probability of a successful relight.

#### 2.5.5.11.11.2 Core Lock

Core lock is a phenomenon that could, in theory, occur in any turbine engine after an abnormal thermal event (e.g., a sudden flameout at low airspeed) where the internal friction exceeds the external aerodynamic driving forces and the “core” of the engine stops. When this occurs, differential contraction of the cooler outside case clamps down on the hotter internal components (seals, blade tips, etc.) preventing rotation or “locking the core.” This seizure may be severe enough to exceed the driving force available by increasing airspeed or from the starter. If differential cooling locks the core, only time will allow the temperature difference to equalize, reduce the contact friction caused by differential contraction, and allow free rotation.

After all engine flameouts, the first critical item is to obtain safe descent speed. Then flight crews need to determine engine status. If any of the engine spools indicate zero, then a situation of core lock may exist or mechanical engine damage could have occurred. If this case applies to all engines, crews must obtain best L/D airspeed instead of accelerating to windmill speed to obtain an optimum glide ratio. Crews then should consider their forced landing options. In the event the seized spool(s) begin to rotate, a relight will be contemplated and windmill airspeed may be necessary.

#### 2.5.5.11.11.3 Rollback

Turbine engine rollback is an uncommon anomaly

consisting of an uncommanded loss of thrust (decrease in EPR or N1), which is sometimes accompanied by an increase in EGT. Rollback can be caused by a combination of many events including moisture, icing, fuel control issues, high angle of attack disrupted airflow, and mechanical failure and usually results in flameout or core lockup. Modern airplanes alleviate most rollback issues with auto-relight. Additionally, updated progressive maintenance programs identify potential problems and help to decrease rollback events. It is conceivable that pilots would recognize the results of rollback rather than the rollback event itself depending on workload and flight experience. If airspeed stagnation occurs, checking of appropriate thrust levels is important as well as increasing airspeed in the case where an engine has rolled back.

#### 2.5.5.12 Flight at Extremely High Speeds

Inadvertent excursions into extremely high speeds, either Mach number or airspeed, should be treated very seriously. As noted in the section on, high-altitude aerodynamics (Sec. 2.5.5.11), flight at very high Mach numbers puts the airplane in a region of reduced maneuvering envelope (closer to buffet boundaries). Many operators opt to fly at very high altitudes, because of air traffic control (ATC) and the greater efficiencies afforded there. But operation very close to buffet-limiting altitudes restricts the range of Mach numbers and load factors available for maneuvering. During certification, all transport airplanes have been shown to exhibit safe operating characteristics with inadvertent exceedances of Mach envelopes. These exceedances may be caused by horizontal gusts, penetration of jet stream or cold fronts, inadvertent control movements, leveling off from climb, descent from Mach-limiting to airspeed-limiting altitudes, gust upsets, and passenger movement. This means that the controls will operate normally and airplane responses are positive and predictable for these conditions. Pilots need to be aware that the maneuvering envelope is small and that prudent corrective action is necessary to avoid exceeding the other end of the envelope during recovery. Pilots should become very familiar with the high-speed buffet boundaries of their airplane and the combinations of weights and altitudes at which they operate.

Flight in the high-air-speed regime brings with it an additional consideration of very high control power. At speeds higher than maneuver speed  $V_A$  (Fig. 14), a *single* very large deflection in pitch or roll has the potential to generate structural damage



or failure. A single full-scale deflection in yaw is acceptable to at least maximum operating speed. At any speed, large aggressive control deflection *reversals* can lead to loads that can exceed structural design limits. It is worth a reminder that certification flight tests involve control input in a *single* axis and *single* direction. Control *reversals* will amplify the loads on the aircraft structures, while possibly leading to overcontrol (and even loss of control) situations.

In either the Mach or airspeed regime, if speed is excessive, the first priority should be to reduce speed to within the normal envelope. Many tools are available for this, including orienting the lift vector away from the gravity vector; adding load factor, which increases drag; reducing thrust; and adding drag by means of the speedbrakes. As demonstrated in Section 2.5.5.7, “Mechanics of Turning Flight,” the single most powerful force the pilot has available is the wing lift force. The second largest force acting on the airplane is the weight vector. Getting the airplane maneuvered so that the lift vector points in the desired direction should be the first priority, and it is the first step toward managing the energy available in the airplane.

#### 2.5.5.13 Defensive, Aggressive Maneuvers

The result of events of September 11, 2001, have prompted a portion of the Flight Operations community to consider the use of the aircraft as a defensive weapon to prevent or slow down a hijacker’s access to a transport category aircraft flight deck. Due to the high probability of injury to passengers/crew and the likelihood of an upset and loss of control or damage to the aircraft, it is not recommended other than as a last resort. Even then, random unplanned maneuvers outside the manufacturer’s recommendations must be avoided.

## 2.6 Recovery From Airplane Upsets

Previous sections of this training aid review the causes of airplane upsets to emphasize the principle of avoiding airplane upsets. Basic aerodynamic information indicates how and why large, swept-wing airplanes fly. That information provides the foundation of knowledge necessary for recovering an airplane that has been upset. This section highlights several issues associated with airplane upset recovery and presents basic recommended airplane-recovery techniques for pilots. There are infinite potential situations that pilots can experience while

flying an airplane. The techniques that are presented in this section are applicable for most situations. It must be emphasized that a developing upset will define how prompt or aggressive the required control inputs will be to recover from the event. In all cases the pilot response to an upset must be appropriate to arrest and recover the condition. Up to full-scale control deflections may be necessary; however, initiating recovery with arbitrary full-scale control deflections could actually aggravate the situation. An excessive or inappropriate control input that overshoots the desired response can startle the pilot and cause one upset to lead to another.

An overview of actions to take to recover from an upset would encompass three basic activities: Manage the energy, arrest the flight path divergence, and recover to a stabilized flight path. These three activities should be part of every recovery from an upset and provide an overview of actions taken.

### 2.6.1 Situation Awareness of an Airplane Upset

In most cases effective situational awareness will avoid an upset from developing in the first place. However, it is important that the first actions for recovering from an airplane upset be correct and timely. Exaggerated control inputs through reflex responses must be avoided. It is worth repeating that inappropriate control inputs during one upset recovery can lead to a different upset situation. ***Troubleshooting the cause of the upset is secondary to initiating the recovery. However, the pilot still must recognize and confirm the situation before a recovery can be initiated. Regaining and then maintaining control of the airplane is paramount.*** Communication between crew members will assist in the recovery actions. At the first indication of an unusual occurrence, the pilot should announce what is being observed.

It is necessary to use the primary flight instruments and airplane performance instruments when analyzing the upset situation. Visual meteorological conditions may allow the use of references outside the airplane. However, it can be difficult or impossible to see the horizon because in most large commercial airplanes, the field of view is restricted due to window geometry and overhead panel placement. For example, the field of view from an airplane that exceeds a 25-deg, noseup attitude probably is limited to a view of the sky. Conversely, the field of view is restricted to the ground for a nose-down pitch attitude that exceeds 10 deg. In

addition, pilots must be prepared to analyze the situation during darkness and when instrument meteorological conditions (IMC) exist. Therefore, the attitude direction indicator (ADI) is used as a primary reference for recovery. Compare the ADI information with performance instrument indications before initiating recovery. For a nose-low upset, normally the airspeed is increasing, altitude is decreasing, and the vertical speed indicator (VSI) indicates a descent. For a nose-high upset, the airspeed normally is decreasing, altitude is increasing, and the VSI indicates a climb. Cross-check other attitude sources, for example, the Standby Attitude Indicator and the pilot not flying (PNF) instruments.

Pitch attitude is determined from the ADI pitch reference scales (sometimes referred to as pitch ladder bars). Most modern airplanes also use colors (blue for sky, brown for ground) or ground perspective lines to assist in determining whether the airplane pitch is above or below the horizon. Even in extreme attitudes, some portion of the sky or ground indications is usually present to assist the pilot in analyzing the situation.

The bank indicator on the ADI should be used to determine the airplane bank.

The situation analysis process is to

- a. Communicate with crew members.
- b. Locate the bank indicator.
- c. Determine pitch attitude.
- d. Confirm attitude by reference to other indicators.
- e. Assess the energy (refer to Section 2.5.2).

Recovery techniques presented later in this section include the phrase, “Recognize and confirm the situation.” This situation analysis process is used to accomplish that technique.

## 2.6.2 Miscellaneous Issues Associated With Upset Recovery

There are issues associated with differences between simulator training and aircraft recoveries. A simulator can provide the basic fundamentals for upset recovery, but some realities such as positive or negative g’s, startle factor, and environmental conditions are difficult or impossible to replicate. These limitations in simulation add a degree of complexity to recovery from an actual aircraft upset because the encounter can be significantly different from that experienced during simulator

training. Therefore memory checklists or procedural responses performed in training may not be repeatable during an actual upset situation. The limitations of simulators at the edges of the flight envelope can also cause fidelity issues because the simulator recovery may or may not have the same response characteristics as the aircraft being flown. However, provided the alpha and beta limits are not exceeded, the initial motion responses and instrument indications of the simulator should replicate airplane responses. The reaction of the simulator is based on given parameters (CG, weight, speeds, etc.). An actual encounter at greatly different parameters than those practiced in the simulator may result in a different aircraft response. For example, flight controls are more effective at 250kn than at 150kn. These same realities exist for thrust asymmetry, wind shear, stall recovery, and the like.

### 2.6.2.1 Startle Factor

It has already been stated that airplane upsets do not occur very often and that there are multiple causes for these unpredictable events. Therefore, pilots are usually surprised or startled when an upset occurs. There can be a tendency for pilots to react before analyzing what is happening or to fixate on one indication and fail to properly diagnose the situation. Proper and sufficient training is the best solution for overcoming the startle factor. The pilot must overcome the surprise and quickly shift into analysis of what the airplane is doing and then implement the proper recovery. ***Gain control of the airplane and then determine and eliminate the cause of the upset.***

### 2.6.2.2 Negative G Force

Airline pilots are normally uncomfortable with aggressively unloading the g forces on a large passenger airplane. They habitually work hard at being very smooth with the controls and keeping a positive 1-g force to ensure flight attendant and passenger comfort and safety. Therefore, they must overcome this inhibition when faced with having to quickly and sometimes aggressively unload the airplane to less than 1 g by pushing down elevator.

Note: It should not normally be necessary to obtain less than 0 g.

While flight simulators can replicate normal flight profiles, most simulators cannot replicate sustained negative-g forces. Pilots must anticipate a

significantly different cockpit environment during less-than-1-g situations. They may be floating up against the seat belts and shoulder harnesses. It may be difficult to reach or use rudder pedals if they are not properly adjusted. Unsecured items such as flight kits, approach plates, or lunch trays may be flying around the cockpit. These are things that the pilot must be prepared for when recovering from an upset that involves forces less than 1-g flight.

### 2.6.2.3 Use of Full Control Inputs

Utilizing full flight control authority is not a part of routine airline flying. Pilots must be prepared to use full flight control authority if the situation warrants it. In normal conditions, flight control inputs become more effective with increased speed/reduced angle of attack. Conversely, at speeds approaching the critical angle of attack, larger control inputs are needed for given aircraft reactions. Moreover, during certain abnormal situations (partial high lift devices, thrust reverser in flight) large or full-scale control inputs may be required. Attitude and flight path changes can be very rapid during an upset and in responding to these sorts of upset conditions, large control inputs may be necessary. It is important to guard against control reversals. There is no situation that will require rapid full-scale control deflections from one side to the other.

### 2.6.2.4 Counter-Intuitive Factors

Pilots are routinely trained to recover from *approach* to stalls. The recovery usually requires an increase in thrust and a relatively small reduction in pitch attitude. Therefore, it may be counter-intuitive to use greater unloading control forces or to reduce thrust when recovering from a high angle of attack, especially at lower altitudes. If the airplane is stalled while already in a nosedown attitude, the pilot must still push the nose down in order to reduce the angle of attack. *Altitude cannot be maintained and should be of secondary importance.*

### 2.6.2.5 Previous Training in Nonsimilar Airplanes

Aerodynamic principles do not change, but airplane design creates different flight characteristics. Therefore, training and experience gained in one model or type of airplane may or may not be transferable to another. *For example, the handling characteristics of a fighter-type airplane cannot be assumed to be similar to those*

*of a large, commercial, swept-wing airplane.* Airplanes with electronic flight control systems may provide protection against entering into many upset situations. These systems also assist the airplane to return to normal flight, if necessary. However, when fly-by-wire airplanes operate in a degraded mode, flight control inputs and the responses can be similar to non fly-by-wire airplanes.

### 2.6.2.6 Potential Effects on Engines

Some extreme airplane upset situations may affect engine performance. Large angles of attack can reduce the flow of air into the engine and result in engine surges or compressor stalls. Additionally, large and rapid changes in sideslip angles can create excessive internal engine side loads, which may damage an engine.

### 2.6.2.7 Post Upset Conditions

Pilots and operations managers need to consider the physiological and psychological aspects that exist after recovering from an upset. Initially, there will be a tendency to overcontrol the airplane because of the large deviations and control inputs previously experienced. Pilots need to dampen out these excursions if they happen. There could be confusion on the flight deck as to what exactly happened to cause the original upset. Care should be taken not to take action that could cause a repeat of the previous upset or let the airplane progress into a different kind of upset. Pilots may not be able to recall the forces experienced or the extent of the maneuvers performed to any great detail. If large g-forces are experienced, then an aircraft inspection would be appropriate. Pilots and operations managers should consider all the aspects of the upset recovery to determine if continued flight or crew changes are required.

## 2.6.3 Airplane Upset Recovery Techniques

*An Airplane Upset Recovery Team comprising representatives from airlines, pilot associations, airplane manufacturers, and government aviation and regulatory agencies developed the techniques presented in this training aid. These techniques are not necessarily procedural. Use of both primary and secondary flight controls to effect the recovery from an upset are discussed. Individual operators must address procedural application within their own airplane fleet*

**structure. The Airplane Upset Recovery Team strongly recommends that techniques for initial recovery emphasize the use of primary flight controls (aileron, elevator, and rudder). Secondary control devices, such as stabilizer trim, thrust, and speed-brakes, may be considered incrementally to supplement primary flight control inputs. Flight crews need to manage the energy, arrest the flight path divergence, and recover to a stabilized flight path.**

For instructional purposes, several different airplane upset situations are discussed. These include the following:

- Nose high, wings level.
- Nose low, wings level.
  - Low airspeed.
  - High airspeed.
- High bank angles.
  - Nose high.
  - Nose low.

This provides the basis for relating the aerodynamic information and techniques to specific situations. **At the conclusion of this recovery techniques section, recommended recovery techniques are summarized into two basic airplane upset situations: nose high and nose low.** Consolidation of recovery techniques into these two situations is done for simplification and ease of retention.

- ◆ Following several situations, where appropriate, abbreviated techniques used for recovery are indicated by the solid diamond shown here.

Airplanes that are designed with electronic flight control systems, commonly referred to as “fly-by-wire” airplanes, have features that should minimize the possibility that the airplane would enter into an upset and assist the pilot in recovery, if it becomes necessary. But, when fly-by-wire airplanes are in the degraded flight control mode, the recovery techniques and aerodynamic principles discussed in this training aid are appropriate. Some environmental conditions can upset any airplane. But the basic principles of recognition and recovery techniques still apply, independent of flight control architecture.

Airplane autopilots and autothrottles are intended to be used when the airplane is within its normal flight regime. **When an airplane has been upset, the autopilot and autothrottle must be disconnected as a prelude to initiating recovery techniques.** Situational analysis of the energy state of the aircraft is also required. This analysis

assesses the energy and trend. This includes but is not limited to altitude, airspeed, attitude, load factor, power setting, position of flight controls, position of drag and high-lift devices, and the rate of change. This analysis may cause the crew to make appropriate changes, such as use of speed brakes or lowering the landing gear for drag as necessary to aid in the recovery. In other words, manage the energy.

### 2.6.3.1 Stall

**The recovery techniques assume the airplane is not stalled.** An airplane is stalled when the angle of attack is beyond the stalling angle. A stall is characterized by any of, or a combination of, the following:

- a. Buffeting, which could be heavy at times.
- b. A lack of pitch authority.
- c. A lack of roll control.
- d. Inability to arrest descent rate.

These characteristics are usually accompanied by a continuous stall warning.

A stall must not be confused with a stall warning that occurs before the stall and warns of an approaching stall. Recovery from an approach to stall warning is not the same as recovering from a stall. An approach to stall is a controlled flight maneuver. A stall is an out-of-control condition, but it is recoverable. **To recover from the stall, angle of attack must be reduced below the stalling angle—apply nosedown pitch control and maintain it until stall recovery.** Under certain conditions, on airplanes with underwing-mounted engines, it may be necessary to reduce thrust to prevent the angle of attack from continuing to increase. **If the airplane is stalled, it is necessary to first recover from the stalled condition before initiating upset recovery techniques.**

### 2.6.3.2 Nose-High, Wings-Level Recovery Techniques

**Situation:** Pitch attitude unintentionally more than 25 deg, nose high, and increasing.

Airspeed decreasing rapidly.

Ability to maneuver decreasing.

Start by disengaging the autopilot and autothrottle and recognize and confirm the situation. Next, apply nosedown elevator to achieve a nosedown pitch rate. This may require as much as full nosedown input. If a sustained column force is required to obtain the

desired response, consider trimming off some of the control force. However, it may be difficult to know how much trim should be used; therefore, care must be taken to avoid using too much trim. Do not fly the airplane using pitch trim, and stop trimming nosedown as the required elevator force lessens. If at this point the pitch rate is not immediately under control, there are several additional techniques that may be tried. The use of these techniques depends on the circumstances of the situation and the airplane control characteristics.

Pitch may be controlled by rolling the airplane to a bank angle that starts the nose down. The angle of bank should not normally exceed approximately 60 deg. Continuous nosedown elevator pressure will keep the wing angle of attack as low as possible, which will make the normal roll controls effective. With airspeed as low as the onset of the stick shaker, or lower, up to full deflection of the ailerons and spoilers can be used. The rolling maneuver changes the pitch rate into a turning maneuver, allowing the pitch to decrease. (Refer to Fig. 33.) In most situations, these techniques should be enough to recover the airplane from the nose-high, wings-level upset. However, other techniques may also be used to achieve a nosedown pitch rate.

If altitude permits, flight tests have shown that an effective method for getting a nosedown pitch rate is to reduce the power on underwing-mounted engines. (Refer to Sec. 2.5.5.11, "Flight at Extremely Low Airspeeds.") This reduces the upward pitch moment. In fact, in some situations for some airplane models, it may be necessary to reduce thrust to prevent the angle of attack from continuing to increase. This usually results in the nose lowering at higher speeds and a milder pitchdown. This makes it easier to recover to level flight.

If control provided by the ailerons and spoilers is ineffective, rudder input may be required to induce a rolling maneuver for recovery. **Only a small amount of rudder input is needed. Too much rudder applied too quickly or held too long may result in loss of lateral and directional control.** Caution must be used when applying rudder because of the low-energy situation. (Refer to Sec. 2.5.5.10, "Directional Maneuvering.")

To complete the recovery, roll to wings level, if necessary, as the nose approaches the horizon. Recover to slightly nose-low attitude to reduce the potential for entering another upset. Check airspeed, and adjust thrust and pitch as necessary.

Nose-high, wings-level recovery:

- ◆ Recognize and confirm the situation.
- ◆ Disengage autopilot and autothrottle.
- ◆ Apply as much as full nosedown elevator.
- ◆ Use appropriate techniques:
  - Roll to obtain a nosedown pitch rate.
  - Reduce thrust (underwing-mounted engines).
- ◆ Complete the recovery:
  - Approaching horizon, roll to wings level.
  - Check airspeed, adjust thrust.
  - Establish pitch attitude.

### 2.6.3.3 Nose-Low, Wings-Level Recovery Techniques

Situation: Pitch attitude unintentionally more than 10 deg, nose low.

Airspeed low.

Recognize and confirm the situation. Disengage the autopilot and autothrottle. Even in a nose-low, low-speed situation, the airplane may be stalled at a relatively low pitch. It is necessary to recover from the stall first. This may require nosedown elevator, which may not be intuitive. Once recovered from the stall, apply thrust. The nose must be returned to the desired pitch by applying noseup elevator. Avoid a secondary stall, as indicated by stall warning or airplane buffet. Airplane limitations of g forces and airspeed must be respected. (Refer to Sec. 2.5.2, "Energy States.")

Situation: Pitch attitude unintentionally more than 10 deg, nose low.

Airspeed high.

Recognize and confirm the situation. Disengage the autopilot and autothrottle. Apply noseup elevator. Then it may be necessary to cautiously apply stabilizer trim to assist in obtaining the desired noseup pitch rate. Stabilizer trim may be necessary for extreme out-of-trim conditions. Reduce thrust, and, if required, extend speedbrakes. The recovery is completed by establishing a pitch, thrust, and airplane configuration that corresponds to the desired airspeed. (Refer to Sec. 2.5.2, "Energy States.") Remember that a very clean airplane can quickly exceed its limits. When applying noseup elevator, there are several factors that the pilot should consider. Obviously, it is necessary to avoid impact with the terrain. Do not enter into an accelerated stall by exceeding the stall angle of attack. Airplane limitations of g forces and airspeed should also be

respected.

Nose-low, wings-level recovery:

- ◆ Recognize and confirm the situation.
- ◆ Disengage autopilot and autothrottle.
- ◆ Recover from stall, if necessary.
- ◆ Recover to level flight:
  - Apply noseup elevator.
  - Apply stabilizer trim, if necessary.
  - Adjust thrust and drag, as necessary.

### 2.6.3.4 High-Bank-Angle Recovery Techniques

Bank angles can exceed 90 deg. In high-bank situations, the primary objective is to roll the airplane in the shortest direction to near wings level. However, if the airplane is stalled, it is first necessary to recover from the stall.

Situation: Bank angle greater than 45 deg.  
Pitch attitude greater than 25 deg,  
nose high.  
Airspeed decreasing.

A nose-high, high-angle-of-bank attitude requires deliberate flight control inputs. A large bank angle is helpful in reducing excessively high pitch attitudes. (Refer to Sec. 2.5.5.8, “Mechanics of Turning Flight.”) Recognize and confirm the situation. Disengage the autopilot and autothrottle. Unload (reduce the angle of attack) and adjust the bank angle, not to exceed 60 deg, to achieve a nosedown pitch rate. Maintain awareness of energy management and airplane roll rate. To complete the recovery, roll to wings level as the nose approaches the horizon. Recover to a slightly nose-low attitude. Check airspeed and adjust thrust and pitch as necessary.

Situation: Bank angle greater than 45 deg.  
Pitch attitude lower than 10 deg,  
nose low.  
Airspeed increasing.

A nose-low, high-angle-of-bank attitude requires prompt action, because altitude is rapidly being exchanged for airspeed. Even if the airplane is at an altitude where ground impact is not an immediate concern, airspeed can rapidly increase beyond airplane design limits. Recognize and confirm the situation. Disengage the autopilot and autothrottle. Simultaneous application of roll and adjustment of

thrust may be necessary. *It may be necessary to unload the airplane by decreasing backpressure to improve roll effectiveness. If the airplane has exceeded 90 deg of bank, it may feel like “pushing” in order to unload. It is necessary to unload to improve roll control and to prevent pointing the lift vector towards the ground.* Full aileron and spoiler input may be necessary to smoothly establish a recovery roll rate toward the nearest horizon. It is important that positive g force not be increased or that nose-up elevator or stabilizer trim be used until the airplane approaches wings level. If the application of full lateral control (ailerons and spoilers) is not satisfactory, it may be necessary to apply rudder in the direction of the desired roll. *Only a small amount of rudder input is needed. Too much rudder applied too quickly or held too long may result in loss of lateral and directional control and cause structural damage.* As the wings approach level, extend speedbrakes, if required. Complete the recovery by establishing a pitch, thrust, and airplane drag device configuration that corresponds to the desired airspeed. In large transport-category airplanes, do not attempt to roll through (add pro-roll controls) during an upset in order to achieve wings level more quickly. Roll in the shortest direction to wings level.

### 2.6.3.5 Consolidated Summary of Airplane Recovery Techniques

These summaries incorporate high-bank-angle techniques.

Nose-high recovery:

- ◆ Recognize and confirm the situation.
- ◆ Disengage autopilot and autothrottle.
- ◆ Apply as much as full nosedown elevator.
- ◆ Use appropriate techniques:
  - Roll (adjust bank angle) to obtain a nosedown pitch rate.
  - Reduce thrust (underwing-mounted engines).
- ◆ Complete the recovery:
  - Approaching the horizon, roll to wings level.
  - Check airspeed, adjust thrust.
  - Establish pitch attitude.

Nose-low recovery:

- ◆ Recognize and confirm the situation.
- ◆ Disengage autopilot and autothrottle.
- ◆ Recover from stall, if necessary.

- ◆ Roll in the shortest direction to wings level—bank angle more than 90 deg, unload and roll.
- ◆ Recover to level flight:
  - Apply noseup elevator.
  - Apply stabilizer trim, if necessary.
  - Adjust thrust and drag as necessary.

After recovering the aircraft, flight crews should assess any damage that may have occurred and the present situation. Crews may consider methods to further improve controllability (shifting CG, adjusting flaps or gear or speedbrake, trim, descending, control wheel breakouts, differential thrust, non-normal procedures, etc.) as the situation dictates. Crews should use the guidance available, consider the issues, and in some cases, validate performance by checks of controllability.





# Example Airplane Upset Recovery Training Program Table of Contents

# 3

Section	Page
3.0	Introduction ..... 3.1
3.1	Academic Training Program ..... 3.1
3.1.1	Training Objectives ..... 3.2
3.1.2	Academic Training Program Modules ..... 3.2
3.1.3	Academic Training Syllabus ..... 3.2
3.1.4	Additional Academic Training Resources ..... 3.3
3.2	Simulator Training Program ..... 3.3
3.2.1	Simulator Limitations ..... 3.3
3.2.2	Training Objectives ..... 3.4
3.2.3	Simulator Training Syllabus ..... 3.4
3.2.4	Pilot Simulator Briefing ..... 3.4
3.2.5	Simulator Training ..... 3.5
	Airplane Upset Recovery Training Syllabus ..... 3.7
	Simulator Training Exercises ..... 3.11
	Exercise 1. Nose-High Characteristics (Initial Training) ..... 3.13
	Exercise 1. Iteration One—Use of Nosedown Elevator ..... 3.13
	Exercise 1. Iteration Two—Use of Bank Angle ..... 3.14
	Exercise 1. Iteration Three—Thrust Reduction (Underwing-Mounted Engines) ..... 3.15
	Exercise 1. Practice—Practice Using All Techniques ..... 3.15
	Exercise 2. Nose-Low Characteristics (Initial Training) ..... 3.17
	Exercise 2. Iteration One—Nose-Low Recovery ..... 3.17
	Exercise 2. Iteration Two—Accelerated Stall Demonstration ..... 3.18
	Exercise 2. Iteration Three—High Bank Angle/Inverted Flight ..... 3.19
	Exercise 3. Optional Practice Exercise ..... 3.21
	Exercise 3. Instructions for the Simulator Instructor ..... 3.21
	Exercise 4: High Altitude Stall Warning ..... 3.23
	Recurrent Training Exercises ..... 3.26
	Appendix 3-A, Pilot Guide to Airplane Upset Recovery Questions ..... App. 3-A.1
	Appendix 3-B, Airplane Upset Recovery Briefing ..... App. 3-B.1
	Appendix 3-C, Video Script: <i>Airplane Upset Recovery</i> ..... App. 3-C.1
	Appendix 3-D, Flight Simulator Information ..... App. 3-D.1
	Appendix 3-E, High Altitude Operations Presentation ..... App. 3-E.i



# Example Airplane Upset Recovery Training Program

# 3

## 3.0 Introduction

The overall goal of the *Airplane Upset Recovery Training Aid* is to increase the ability of pilots to recognize and avoid situations that may lead to airplane upsets and improve the pilots' ability to recover control of an airplane that has exceeded the normal flight regime. This may be accomplished by increasing awareness of potential upset situations and knowledge of aerodynamics and by application of this knowledge during simulator training scenarios. Therefore, an academic and training program is provided to support this goal.

This "Example Airplane Upset Recovery Training Program" is structured to stand alone, but it may be integrated into existing initial, transition, and recurrent training and check programs, if desired. The Academic Training Program is designed to improve awareness by increasing the pilot's ability to recognize and avoid those situations that cause airplanes to become upset. The academic program also provides aerodynamic information associated with large, jet, swept-wing airplanes. This information provides the basis for understanding aircraft behavior in order to avoid upsets and for understanding why various upset recovery techniques are recommended. Finally, airplane upset recovery techniques are provided for pilots to use to return an airplane to the normal flight regime once it has been upset. Because of the infinite variables that comprise upset situations, the Industry group unanimously agree that airplane upset recovery education must not include simulator testing criteria. By definition, testing implies procedure demonstration and objective assessment of performance. The goal of upset recovery is to regain aircraft flight path control. A testing environment could lead to similar negative learning conclusions that can currently exist with approach to stall performance when measured against minimum loss of altitude.

The Simulator Training Program includes a simulator briefing outline and simulator exercises. These exercises are designed for pilots to analyze upset situations and properly apply recovery techniques. A methodical building block approach is used so that pilots can learn the effect of each recovery technique and develop the required piloting skills in applying them. The recommended exercises are the minimum that pilots should accomplish. Operators are encouraged to develop additional exercises and scenarios. Recurrent training should, to the maximum extent possible, use real-time situation-integrated presentations with various levels of automation. Over several recurrent cycles, flight crews should be presented with upsets involving various levels of pilot and automation interface. Good communication, crew coordination, and other skills associated with crew resource management should be an integral part of recurrent training in upset recovery. Use of airplane systems, flight control, or engine malfunctions to accomplish these objectives is encouraged. However, training scenarios should not exceed the limitations of simulator engineering data or mechanical operation. Use of simulators beyond their mechanical or engineering data capabilities can lead to counterproductive learning and should be avoided. Operators are encouraged to assess the capabilities of their simulators and improve them, if necessary, to conduct this training. Simulator engineering information is provided in Appendix 3-D. The purpose of this information is to aid operators in assessing simulators.

## 3.1 Academic Training Program

The Academic Training Program focuses on the elements that are important to preventing an airplane from being upset and recovery techniques available for returning an airplane to the normal flight regime.

### 3.1.1 Training Objectives

The objectives of the training program are to provide the pilot with the following:

- a. Aerodynamic principles of large, swept-wing airplanes.
- b. The ability to recognize situations that may lead to airplane upsets so that they may be prevented.
- c. Airplane flight maneuvering information and techniques for recovering from an airplane upset.
- d. Skill in using upset recovery techniques.

A suggested syllabus is provided, with the knowledge that no single training format or curriculum is best for all operators or training situations. All training materials have been designed to “stand alone.” As a result, some redundancy of the subject material occurs. However, using these materials together in the suggested sequence will enhance overall training effectiveness.

### 3.1.2 Academic Training Program Modules

The following academic training modules are available for preparing an academic training curriculum.

**Pilot Guide.** The “Pilot Guide to Airplane Upset Recovery” (*Airplane Upset Recovery Training Aid*, Sec. 2) is a comprehensive treatment of prevention and lessons learned from past upset accidents and incidents. The pilot guide is designed as a document that should be reviewed by an individual pilot at any time before formal upset recovery academic or simulator training.

**Pilot Guide Questions.** A set of questions based on the material contained in the Pilot Guide is contained in Appendix 3-A. These questions are designed to test the pilot’s knowledge of each section of the Pilot Guide. In an airplane upset recovery curriculum, these questions may be used in one of two ways:

- a. As part of a pilot’s review of the Pilot Guide.
- b. As an evaluation to determine the effectiveness of the pilot’s self-study prior to subsequent academic or simulator training for upset recovery.

**Airplane Upset Recovery Briefing.** A paper copy of viewfoils with descriptive words for each one that can be used for a classroom presentation is contained in Appendix 3-B. The briefing supports a classroom discussion of the Pilot Guide.

**Video (optional).** *Airplane Upset Recovery*—This video is in two parts. Part One is a review of causes of the majority of airplane upsets. It emphasizes awareness as a means of avoiding these events. Part One also presents basic aerodynamic information about large, swept-wing airplanes. This part of the video provides the background necessary for understanding the principles associated with recovery techniques. Part Two presents airplane upset recovery techniques for several different upset situations. Part Two is excellent as an academic portion of recurrent training.

### 3.1.3 Academic Training Syllabus

All or part of the suggested Academic Training Program can be presented. The most effective method is a combination of all of the previous academic training modules into a comprehensive training syllabus. The information provided in this

Figure 1  
Suggested Academic  
Training Program

Training Module	Method of Presentation
Pilot Guide (Section 2)	Self-study/classroom: <i>The pilot can either study and review section 2 or a presentation can be given using Appendix 3-B.</i>
Pilot Guide Questions (Section 3-A)	Self-study/classroom: <i>The pilot can study and review section 3A or a standup briefing from an instructor can be conducted.</i>
Video (Section 3-C)	Classroom: <i>The video can be presented after or before self-study/classroom.</i>

training guide can be utilized as recommended or can be configured into e-based training if desired. Figure 1 shows a suggested Academic Training Program.

### 3.1.4 Additional Academic Training Resources

The *Airplane Upset Recovery Training Aid* is provided in CD-ROM DOS format. The complete document and the two-part video are included in this format. This allows for more flexible training options and makes the information readily available to pilots. For example, the Pilot Guide (Sec. 2 of the document) may be printed from the CD-ROM format and distributed to all pilots.

## 3.2 Simulator Training Program

The Simulator Training Program addresses techniques that pilots should use to recover an airplane that has been upset. Training and practice are provided to allow the pilot to, as a minimum, recover from nose-high and nose-low airplane upsets. The exercises have been designed to meet the following criteria:

- a. Extensive simulator engineering modification will not be necessary.
- b. All exercises will keep the simulator within the mathematical models and data provided by the airplane manufacturer.
- c. Exercises will not result in negative or counterproductive training.

To be most effective, simulator training requires the pilot-in-training to be familiar with the material in the Academic Training Program.

Simulator training exercises are developed so that an operator needs only minimum training capability to encourage the implementation of an effective airplane upset recovery training program. The training exercises may be initiated by several means:

- a. Manual maneuvering to the demonstration parameters.
- b. Automated simulator presets.
- c. Stabilizer trim to induce the demonstration as best suits the pilot-in-training requirements.
- d. Other appropriate airplane-system, flight-control, or engine malfunctions.

Instructors may be called on to maneuver the simulator to assist the pilot-in-training in order to obtain the desired parameters and learning objectives. The instructors need to be properly trained to avoid nonstandardized or ineffective training.

### 3.2.1 Simulator Limitations

Simulator capabilities have evolved to provide accurate duplication of airplane characteristics within the normal operating envelope. Since the normal working environment of the airline pilot does not encompass vertical or lateral load transients, simulator limitations in that area are negligible. However, airplane upsets often will involve g load excursions and these cannot be duplicated within the simulator environment. They have not been designed for the purpose of replicating upsets, and as such, whenever maneuvering involves vertical or lateral loading, the realism degrades. This is a very important point for both the trainee and the instructor. Instructional content must acknowledge this limitation and fortify instructional content based upon the trainee's prior flight experience with g load excursions. Without this instructional input, a positive learning goal can be transformed into a negative learning experience.

Simulator fidelity relies on mathematical models and data provided by the airplane manufacturer. The simulator is updated and validated by the manufacturer using flight data acquired during the flight test program. Before a simulator is approved for crew training, it must be evaluated and qualified by a regulatory authority. This process includes a quantitative comparison to actual flight data for certain test conditions, such as those specified in the International Civil Aviation Organization (ICAO) *Manual of Criteria for the Qualification of Flight Simulators*. These flight conditions represent airplane operation within the normal operating envelope.

When properly accomplished, the training recommended in this training aid should be within the normal operating envelope for most simulators. However, operators must assess their simulators to ensure their ability to support the exercises. This assessment should include, at a minimum, aerodynamic math models; their associated data tables; and the performance capabilities of visual, flight instrument, and motion systems to support maneuvers performed in the simulator.

Appendix 3-D, “Flight Simulator Information,” was developed to aid operators and training organizations in assessing their simulators. The information is provided by airplane manufacturers and based on the availability of information. Simulator manufacturers are another source for information.

The simulation may be extended to represent regions outside the typical operating envelope by using reliable predictive methods. However, flight data are not typically available for conditions where flight testing would be very hazardous. From an aerodynamic standpoint, the regimes of flight that are not generally validated fully with flight test data are the stall region and the region of high angle of attack with high-sideslip angle. While numerous approaches to a stall or stalls are flown on each model (available test data are normally matched on the simulator), the flight controls are not fully exercised during an approach to stall, or during a full stall, because of safety concerns. Training maneuvers in this regime of flight must be carefully tailored to ensure that the combination of angle of attack and sideslip angle reached in the maneuver do not exceed the range of validated data or analytical/extrapolated data supported by the airplane manufacturer. The values of pitch, roll, and heading angles, however, do not affect the aerodynamics of the simulator or the validity of the training as long as angle of attack and sideslip angles do not exceed values supported by the airplane manufacturer. For example, a full 360-deg roll maneuver conducted without exceeding the valid range of the angle of attack and sideslip angle will be correctly replicated from an aerodynamic standpoint. However, the forces imposed on the pilot and the ratio of control forces to inertial and gravity forces will not be representative of the airplane.

Simulator technology continues to improve, which allows more training opportunities. However, trainers and pilots must understand that simulators still cannot replicate all things. For example, sustained g forces, both negative and positive, are not replicated. This means that a pilot cannot rely on complete sensory feedback that would be available in an actual airplane. Additionally, such things as loose items that would likely be floating in the cockpit during a negative-g situation are clearly not replicated in the simulator. However, a properly programmed simulator should provide accurate control force feedback (absent any sustained g loading), and the motion system should provide airframe buffet consistent with the aerodynamic characteristics of the airplane which could

result from control input during certain recovery situations.

The importance of providing feedback to a pilot when control inputs would have exceeded airframe, physiological, or simulator model limits must be recognized and addressed. Some simulator operators have effectively used a simulator’s “crash” mode to indicate limits have been exceeded. Others have chosen to turn the visual system red when given parameters have been exceeded. Simulator operators should work closely with training departments in selecting the most productive feedback method when selected parameters are exceeded.

### 3.2.2 Training Objectives

The objective of the Simulator Training Program is to provide pilots with the necessary experience and skills to

- a. Recognize and confirm airplane upset.
- b. Gain confidence and understanding in maneuvering the airplane during upsets.
- c. Successfully apply proper airplane upset recovery techniques.

### 3.2.3 Simulator Training Syllabus

The training given during initial, transition, and recurrent phases of training should follow a building block approach. The first time an upset is introduced, it should be well briefed and the pilot should have general knowledge of how the airplane will react. Since full limits of control forces may be necessary during a recovery from an upset, it may be appropriate to allow the pilot opportunity for maneuvering using all flight control inputs.

Exercises are initiated by the instructor pilot. Once the desired upset situation is achieved, the pilot-in-training then applies appropriate techniques to return the airplane to its normal flight regime or to maneuver the airplane during certain demonstrations, depending on the exercise. It may take several iterations before the pilot-in-training has the required skills for recovering the airplane.

### 3.2.4 Pilot Simulator Briefing

Pilots should be familiar with the material in the Ground Training Program before beginning Airplane Upset Recovery Training. However, a briefing should be given to review the following:

- a. Situation analysis process:
  1. Callout of the situation.
  2. Location of the bank indicator.
  3. Determination of the pitch attitude.
  4. Confirmation of attitude by reference to other indicators.
  5. Assessment of the energy.
- b. Controlling the airplane before determining the cause of the upset.
- c. Use of full control inputs.
- d. Counter-intuitive factors.
- e. G-force factors.
- f. Use of automation.
- g. Recovery techniques for nose-high and nose-low upsets.
- h. Limitations of simulator
  1. Angle of attack, sideslip, and fidelity
  2. Forces experienced

### 3.2.5 Simulator Training

The following is a sample lesson description and instructor notes that can be used by an operator to conduct airplane upset recovery training in the simulator.

Before flying the simulator training exercises, it is highly recommended that the pilot be exposed to the handling characteristics and airplane responses to the primary and secondary flight control and thrust inputs that will be used to effect recovery from an airplane upset. The sample lesson describes the preexercise preparation. The proficiency and skill of the pilot-in-training should be considered in determining the amount of preexercise preparation. Operators may select the events described or may develop others, depending on airplane model.

During simulator training exercises for upset recognition and recovery, it is recommended that the instructor be in a position to fully view the control inputs applied during recovery. This ensures the instructor has the ability to assess the control inputs being used and likewise the ability to make timely and relevant critique of the recovery event. Should the necessity arise, the instructor should be capable of demonstrating proper recovery technique.





# Airplane Upset Recovery Training Syllabus

## 3

### Lesson Summary

This lesson is a flight from Grant County International Airport. The crew does not perform a complete preflight. Overhead panel, MCP, IRS alignment, and engines are the responsibility of the IP. The student(s) will load the FMC. A normal takeoff will be conducted, followed by exercises in handling characteristics, airplane responses to primary and secondary flight control, and thrust inputs that will be used to effect recovery from an airplane upset. The preexercise preparation events are flown with the pilot-in-training at the controls. The intent is to allow the pilots to gain confidence in their ability to fly the airplane when it is outside its normal flight regime. This preparation provides the opportunity for pilots to develop recovery decision-making skills and become familiar with the use of operator procedures. This in turn prepares the pilot for completing the nose-high and nose-low follow-on exercises. During recovery practice, the student will experience three nose-high and three nose-low airplane upsets. Each of these maneuvers requires the pilot to return the airplane to a normal flight condition. The expectation is that the student learns to manage the energy, arrest the flight path divergence, and recover to a stabilized flight path. A random nose high and nose-low exercise will be given after the training maneuvers.

The nose-high recovery will be set up so that at least a 40-deg noseup condition is reached. For the nose- low recovery, at least a 20-deg nose-low attitude will be reached. In all cases the instructor will attempt to maintain the airplane within the fidelity of the simulator motion and capability.

### Lesson Objectives

- Attain better understanding of the aerodynamic principles of large, swept-wing airplanes.
- Have a thorough understanding of application of flight controls in reference to roll rate, pitch rate, and the interrelationship with thrust, particularly for underwing-mounted engines.
- Be able to recognize situations that may lead to airplane upsets so that they may be prevented.
- Recognize and confirm airplane upset.
- Gain confidence and understanding in maneuvering the airplane during upsets.
- Develop skill for recovery from a nose-high airplane upset.
- Demonstrate low-speed and high-speed accelerated stall recovery.
- Develop skill for recovery from a nose-low airplane upset.

### Route of Flight

ORIGIN	KMWH, Hold Short of Runway
ROUTE	EPH, direct ELN, direct MWH
DEPARTURE	Radar Vectors
DESTINATION	Grant County International Airport (KMWH)
ALTERNATE	Spokane International Airport (KGEG)
FLIGHT NUMBER	TRAINER XX

**Performance**

GROSS WT:	Max Landing Weight	FLAPS	Appropriate for runway (use average operational flap setting).
CG:	Mid-Range		
FUEL:	2+ hours		
ZFW:	Appropriate for conditions	WIND	230/10
RESERVES:	1 Hour	SLOPE	0
CRZ ALT	3000 ft	EO ACCEL HT	1000 ft
COST INDEX	Appropriate for conditions	ACCEL HT	1000 ft
THRUST LIM	TO 2 or 49°C	THR REDUCTION	1500 ft

**Weather**

MWH Clear / 20 miles // Temperature 59°F (15°C) / D.P. 50°F (10°C) // Wind 230 / 10 // QNH 29.92 HG (1013 MB) // ILS RWY 32R in use / Landing and departing RWY 32R.

**Clearance**

Trainer xx is cleared to the Grant County International Airport, Direct EPH, Direct ELN, Direct MWH, Departure control frequency 128.5 squawk 1444.

**Preflight**

Student and Instructor should setup through the after start checklist. Begin with Before Takeoff Checklist.

**T/O**

Climb initially to 3000 ft, stabilize at a speed and configuration the aircraft would have just prior to gear lowering on approach. It is recommended not accomplish these exercises at high altitude because pitch attitudes may be unachievable.

**Handling Characteristics/Airplane Response**

- Roll rate with full aileron/spoiler input: Student should roll to 60 deg of bank, neutralize the controls at 60 deg, then rapidly roll in the opposite direction to 60 deg of bank, neutralize the controls at 60 deg, and then return to level flight. Maintain approximately level flight and constant airspeed. During the training exercise, the student will practice using full rates of aileron authority. A common student error is trying to be too smooth or not using full control authority when needed. With large roll rates the student should notice the increased drag. The student should note the rate of roll and the controllability. Do not let the student do rapid cyclic reversals of the controls.
- Roll rate with rudder input: Student should roll using only rudder to 15 deg of bank, neutralize the controls at 15 deg, then rapidly roll in the opposite direction to 15 deg of bank, neutralize the controls at 15 deg, and then return to level flight. Maintain approximately level flight and constant airspeed. Large swept-wing transport aircraft are normally not maneuvered with the rudder except for non-normal flight control conditions, takeoff and landing crosswinds, or when there are asymmetric thrust requirements. It is very easy for the airplane to exceed normal bank conditions

when rudder is used to roll the airplane during these conditions. The instructor may suggest that the student put his hands on the column only to maneuver in pitch. In this exercise, the student will practice using the rudder at different amounts of rudder displacement and rates to see how the airplane reacts. The student should note the roll rate and the controllability difficulty. The student should note the delay of roll and nose movement when rudder is applied and then the roll due to sideslip. Do not allow the student to reverse the rudder inputs in a cyclic manner.

3. Pitch change with use of only stabilizer trim: Adjust stabilizer trim nose high and nose low and note the rate of pitch change and forces. Pitch rate change occurs slowly because the stabilizer trim change is slow. Column forces can be considerable after large stabilizer movements. During a low speed condition, or a very high-speed condition, there may not be enough elevator authority to recover the airplane to a stable condition.
4. Pitch change with the use of thrust adjustments: From a stabilized power setting, rapidly add full power and note the pitch change at this low speed. From a stabilized power setting, reduce thrust rapidly to idle. Underwing-mounted engines will induce a significant noseup pitch with power addition on most models. This pitch up would be even more significant at an even lower speed and less significant at higher speeds.
5. Pitch change with the use of speedbrakes: From a stabilized condition, rapidly deploy the flight spoilers. Normally, deployment of speedbrakes will cause the airplane to pitch up. This usually becomes more pronounced as speed increases.
6. Yaw motion and resultant roll due to asymmetric thrust with autopilot: From a stabilized condition with the autopilot on, reduce thrust rapidly to idle on one engine. Note the yaw and resultant roll. Note the autopilot's attempt to control roll and the decaying condition with airspeed reducing. Note the forces and necessary inputs to recover after disconnecting autopilot.
7. Yaw motion and resultant roll due to asymmetric thrust without autopilot: From a stabi-

lized condition, rapidly retard one engine to idle. Recover when reaching 30 deg of bank. Note the rapid onset of roll without autopilot input.

8. Approach to stall recovery (PLI/Stick Shaker) using only pitch control: Reduce thrust from a stabilized condition and maintain altitude until stick shaker or airplane buffet is noted. Recover to previous stabilized airspeed using pitch control only. Although not a recommended technique for recovery, the student will note the importance of controlling the angle of attack in order to recover. Note recovery pitch attitude and altitude loss.

**Fly-by-wire qualities (if applicable):** Demonstrate fly-by-wire safety features that enhance controllability and help prevent upsets.

**Exploring Jet Upset Parameters:** In this exercise the student will fly the airplane beyond the defined upset parameters (e.g., pitch attitude greater than 25 deg, nose up; pitch attitude greater than 10 deg, nose down, bank angle greater than 45 deg). *This familiarizes the pilot-in-training with the picture of an upset situation. It allows practice in recognizing an upset and applying the correct maneuver to return to normal flight regime, helps to incorporate proper control inputs, including primary and secondary controls and thrust, as well as integrate the procedural steps for upset recovery (e.g., recognizing and confirming the situation, disengaging the autopilot and autothrottle, etc.)*

Accelerate to within 25 kn of  $V_{mo}$  while maintaining 3000 ft. Repeat the above conditions as necessary and within high-speed maneuvering limitations. Note the differences that exist at the high-speed condition.

The instructor should identify common pilot-in-training errors during the preexercise preparation. Examples of these errors include the following:

- a. Initiating the roll in the wrong direction.
- b. Applying elevator backpressure when over 90 deg of bank.
- c. Failure to use up to full control inputs when required.
- d. Failure to use established operator techniques or procedures.



# Simulator Training Exercises

# 3

## Exercise 1. Nose-High Characteristics

### Objective

- Develop skills for recovery from a nose-high airplane upset.

## Exercise 2. Nose-Low Characteristics

### Objectives

- Demonstrate low-speed and high-speed accelerated stalls.
- Develop skills for recovery from a nose-low airplane upset.

## Exercise 3. Optional Practice Exercise

### Objectives

- Develop skills for recovery from a nose-high, low-energy airplane upset.
- Expose the pilot to a realistic airplane upset that requires disengaging the autopilot and autothrottle.

## Exercise 4. High Altitude Stall Warning Exercise



## Exercise 1. Nose-High Characteristics (Initial Training)

### Objective

Develop skills for recovery from a nose-high airplane upset.

### General Description

This exercise should be used for initial training. The pilot is exposed to airplane nose-high aerodynamic characteristics. The exercise is designed to allow the pilot-in-training to develop proficiency in techniques for recovering from a nose-high airplane upset. Specifically, the pilot-in-training is required to recover from a minimum of a 40-deg, nose-high upset by recognizing and confirming the situation, verifying that the autopilot and autothrottle are disengaged, and applying appropriate recovery techniques. The first iteration requires the pilot-in-training to use up to full nose-down elevator. The second iteration requires the pilot-in-training to roll the airplane as a technique for reducing the pitch. The third iteration requires the pilot-in-training to use thrust reduction as a pitch-reduction recovery technique, if the airplane model has underwing-mounted engines. All iterations require the pilot to complete the recovery by rolling to wings level, if necessary, and, at the appropriate time, checking airspeed and establishing a final recovery pitch attitude.

### Initial Conditions

Altitude: 1000 to 5000 ft above ground level.

Center of gravity: Midrange.

Airspeed: Maneuvering plus 50 kn.

Autopilot: Disengaged.

Autothrottle: Disengaged.

Attitude: \_\_\_\_\_ 40-deg, noseup pitch, wings level.

## Exercise 1. Iteration One—Use of Nosedown Elevator

### Instructions for the Instructor Pilot

1. Establish initial conditions. Briefly point out or discuss the pitch-angle scale for various pitch attitudes. Have the pilot-in-training note the pitch attitude for the initial conditions.
2. Initiate the exercise by the following means:
  - a. Manual maneuvering to the demonstration parameters. *Add full power and slowly pitch up wings level to slightly greater than 40 deg nose up. The instructor should add noseup trim as much as possible during the pitch up so that the airplane will want to pitch up further upon the exchange of control to the pilot-in-training. Slightly reduce power just prior to exchange of control.*
  - b. Automated simulator presets.
3. Transfer airplane control to the pilot-in-training.
4. As the airplane pitch attitude passes approximately 40 deg, instruct the pilot-in-training to initiate recovery by simulating disengaging the autopilot and autothrottle and countering pitch: by use of up to full nosedown elevator and, if required, by using stabilizer trim to relieve elevator control pressure. A steady nosedown pitch rate should be achieved and it should be noted that the airplane would be near zero g and the associated characteristics of such.
5. The pilot-in-training completes the recovery when approaching the horizon by checking airspeed, adjusting thrust, and establishing the appropriate pitch attitude and stabilizer trim setting for level flight.

**Common Instructor Pilot Errors**

- a. Achieves inadequate airspeed at entry.
- b. Attains stall angle of attack because of a too aggressive pull-up.
- c. Does not achieve full parameters before transfer of airplane control to the pilot-in-training.

**Common Pilot-in-Training Errors**

- a. Fails to simulate disengaging the autopilot and autothrottle.
- b. Hesitates to use up to full control input.
- c. Overtrims nosedown stabilizer.
- d. Fails to induce noseup stabilizer trim.

**Exercise 1. Iteration Two—Use of Bank Angle****Instructions for the Instructor Pilot**

1. Establish initial conditions.
2. Initiate the exercise by the following means:
  - a. Manual maneuvering to the demonstration parameters. *Add full power and slowly pitch up wings level to slightly greater than 40 deg nose up. The instructor should add noseup trim as much as possible during the pitch up so that the airplane will want to pitch up further upon the exchange of control to the pilot-in-training. Slightly reduce power just prior to exchange of control.*
  - b. Automated simulator presets.
3. Slowly release the control column.
4. Have the pilot-in-training roll the airplane until a nosedown pitch rate is achieved. Some forward column pressure may be required. 30 to 60 deg roll should be sufficient to establish a nosedown pitch rate. Avoid bank angles in excess of 60 deg.

**Common Instructor Pilot Errors**

- a. Too low of speed at entry (not enough energy).
- b. Stalls the airplane before pull-up is completed.
- c. Fails to induce noseup stabilizer trim.

**Common Pilot-in-Training Errors**

- a. Achieves the required roll too slowly, which allows the nose to drop too slowly and airspeed to become excessively low.
- b. Continues the roll past what is required to achieve a nosedown pitch rate; therefore, the difficulty of recovery is unnecessarily increased.
- c. Rolls out at a pitch attitude that is too high for conditions and encounters an approach to stall.



## Exercise 1. Iteration Three—Thrust Reduction (Underwing-Mounted Engines)

### Instructions for the Instructor Pilot

1. Establish initial conditions.
2. Initiate the exercise by the following means:
  - a. Manual maneuvering to the demonstration parameters. *Add full power and slowly pitch up wings level to slightly greater than 40 deg nose up. The instructor should keep the airplane neutrally trimmed up to the exchange of control to the pilot-in-training.*
  - b. Automated simulator presets.
3. Slowly release the control column.
4. Transfer airplane control to the pilot-in-training.
5. Instruct the pilot-in-training to initiate recovery by reducing thrust to approximately midrange until a detectable nosedown pitch rate is achieved.
6. The pilot-in-training completes the recovery when approaching the horizon by checking airspeed, adjusting thrust, and establishing the appropriate pitch attitude and stabilizer trim setting for level flight.

### Common Instructor Pilot Errors

- a. Fails to keep trim neutral.
- b. Fails to achieve entry parameters.
- c. Stalls the airplane before pull-up is completed.

### Common Pilot-in-Training Errors

- a. Fails to simulate disengaging the autopilot and autothrottle.
- b. Fails to reduce thrust sufficiently to obtain nosedown pitch.
- c. Reduces thrust excessively.

## Exercise 1—Practice Using All Techniques

If training time permits, the instructor should allow the pilot-in-training to use all three techniques to effect a recovery. The instructor should place the airplane in a position similar to the previous iterations with some small bank angle already achieved. Stabilizer trim should be as much nose up as possible. Allow the student to use all available techniques to recover the airplane.



## Exercise 2. Nose-Low Characteristics (Initial Training)

### Objectives

- Demonstrate low-speed and high-speed accelerated stalls.
- Develop skills for recovery from a nose-low airplane upset.

### General Description

This exercise should be used for initial training. Selected iterations should also be used for recurrent training as determined by the operator. The pilot is exposed to airplane nose-low aerodynamic characteristics. The exercise is designed to demonstrate what an approach to accelerated stall is and how to recover from it. The pilot-in-training is required to recover from a minimum of a 20-deg nose-low upset. High-bank-angle (up to inverted flight), nose-low upset iterations are used. To recover, the pilot-in-training recognizes and confirms the situation and verifies that the autopilot and autothrottle are disengaged. Thrust is adjusted for the appropriate energy condition. For a satisfactory nose-low recovery, the pilot-in-training must avoid ground impact and accelerated stall and respect g-force and airspeed limitations. The pilot-in-training is required to recover to stabilized flight with a pitch, thrust, and airplane configuration that corresponds to the desired airspeed.

### Initial Conditions

Altitude: 5000 to 10000 ft above ground level.

Center of gravity: Midrange.

Airspeed: Flaps up maneuvering speed.

Autopilot: Disengaged.

Autothrottle: Disengaged.

Attitude: Level flight.

## Exercise 2. Iteration One—Nose Low Recovery

### Instructions for the Instructor Pilot

1. Begin the exercise while in level unaccelerated flight at flaps up maneuver speed.
2. Have the pilot-in-training pull up gently to 20 deg nose up and then start to slowly roll the aircraft while allowing the nose to drop.
3. Have the pilot-in-training observe the nose drop and airspeed increase and the outside view change to mostly ground with just a 10- to 20-deg nose-low altitude.
4. Shoot for approximately 20 deg nose low and 60 to 70 deg of bank before initiating recovery.
5. Instruct the pilot-in-training to recover by recognizing and confirming the situation; verifying that the autopilot and autothrottle are disengaged; rolling to approaching wings level, then applying noseup elevator; applying stabilizer trim, if necessary; and adjusting thrust and drag as necessary.

### Common Instructor Pilot Errors

- Allowing airplane to exceed limits of the simulator or past the airspeed limits of the airplane thus causing negative training.

**Common Pilot-in-Training Errors**

- a. Forgets to disengage the autopilot and or autothrottle.
- b. Fails to use full control inputs.
- c. Initiates pull-up before approaching wings level.
- d. Attempts to precisely obtain wings level and delays pull-up.
- e. Enters secondary stall.
- f. Exceeds positive g force during pull-up.
- g. Fails to reduce thrust to idle for high speed.
- h. Fails to use speedbrakes, if required.
- i. Achieves inadequate pull-up to avoid ground impact.

**Exercise 2. Iteration Two—Accelerated Stall Demonstration****Instructions for the Instructor Pilot**

1. Establish initial conditions.
2. Initiate the exercise by the following means:  
The instructor should apply noseup elevator and some small amount of noseup stabilizer trim to slowly achieve approximately a 20-deg noseup pitch. Do not change the entry thrust. Upon reaching approximately a 20-deg noseup pitch, roll the airplane to approximately 90 deg of bank and allow the nose to fall. Tell pilot-in-training to maintain this bank for the first accelerated stall recovery.
3. Have the pilot-in-training note the reduced ability to visually detect the horizon once below 10 deg, nose low.
4. Transfer airplane control to the pilot-in-training.
5. When slightly nose low and at minimal airspeed, have the pilot-in-training apply sufficient backpressure until achieving stick shaker. Note the airspeed then unload to eliminate stick shaker. Emphasis should be that recovery should then be conducted but for demonstration purposes (to show both high- and low-speed accelerated stalls) the bank will be maintained and airspeed allowed to increase. At a high airspeed, once again have the student apply sufficient backpressure until achieving stick shaker. Note the airspeed, then unload and initiate recovery.
6. Recovery is accomplished by recognizing and confirming the situation and verifying that the autopilot and autothrottle are disengaged. The pilot-in-training rolls to approaching wings level and then recovers to level flight by applying noseup elevator and noseup stabilizer trim, if necessary, and adjusting thrust and drag as necessary.

**Common Instructor Pilot Errors**

- a. Allows airspeed to become excessive for final recovery.
- b. Allows the pilot-in-training to pull to stick shaker too quickly, and angle of attack exceeds simulator fidelity.
- c. Allows the pilot-in-training to reduce bank angle and pitch before final recovery.

**Common Pilot-in-Training Errors**

- a. Too aggressive of a pull results in aggravated stall and lack of simulator realism.

- b. Fails to sufficiently unload the aircraft.
- c. Rolls to wings level while simultaneously applying large amounts of backpressure.
- d. Adjusts bank angle when near wings level to achieve wings level and delays pull-up.
- e. Fails to retard thrust and deploy speedbrakes as needed.

## **Exercise 2. Iteration Three—High Bank Angle/Inverted Flight**

### **Instructions for the Instructor Pilot**

1. Establish initial conditions.
2. Initiate the exercise by the following means:
  - a. Manual maneuvering to the demonstration parameters.
  - b. Automated simulator presets.

**Note:** For manual maneuvering to the demonstration parameters, the instructor pilot applies noseup elevator assisted with small amounts of noseup stabilizer trim to slowly achieve approximately a 20-deg noseup pitch. Do not change entry thrust.
3. Instructor should roll the airplane slowly to achieve approximately 110 to 120 deg of bank and approximately 20 deg nose low.
4. Transfer airplane control to the pilot-in-training.
5. Have the pilot-in-training note the reduced ability to visually detect the horizon.
6. When approximately 20 deg below the horizon, the pilot-in-training recovers by recognizing and confirming the situation and verifying that the autopilot and autothrottle are disengaged. The pilot-in-training must unload and roll. The pilot-in-training, when approaching wings level, recovers to level flight by applying noseup elevator and noseup stabilizer trim, if necessary, and adjusting thrust and drag as necessary.

### **Common Pilot-in-Training Errors**

- a. Forgets to disengage the autopilot or autothrottle.
- b. Fails to unload.
- c. Fails to use sufficient control inputs.
- d. Initiates pull-up before approaching wings level.
- e. Attempts to precisely obtain wings level and delays pull-up.
- f. Exceeds positive g-force limits during pull-up.
- g. Fails to reduce thrust to idle for high speed.
- h. Fails to use speedbrakes, if required.
- i. Achieves inadequate pull-up to avoid ground impact.

### **Common Instructor Pilot Errors**

- a. Allows airspeed to become excessive for final recovery.
- b. Allows the pilot-in-training to pull to stick shaker too quickly and exceed stall angle of attack or g-force limit.
- c. Fails to notice improper control inputs.



### Exercise 3. Optional Practice Exercise

#### Objectives

- Develop skills for recovery from a nose-high, low-energy airplane upset.
- Expose the pilot to a realistic airplane upset that requires disengaging the autopilot and autothrottle.

#### General Description

This exercise may be used for initial training modified for the airplane model. It is a good example for a recurrent training scenario. The instructor pilot is not required to occupy a pilot position. No additional training time is required, since a normal takeoff and departure is continued. The pilots are exposed to a nose-high, low-energy situation. It allows the pilot-in-training to experience a challenging airplane upset recovery. The focus of this exercise is on the entry and recovery from an airplane upset, not on the engine thrust reduction. Malfunction analysis or nonnormal procedure accomplishment should not be done. A normal takeoff is made. During the second segment climb with the autopilot and autothrottle engaged at 1000 ft above ground level, thrust is reduced to idle on one engine (the outboard engine for airplanes with more than two engines). The intent is to create a nose-high, significant yaw and roll condition with decreasing airspeed. The instructor should be the one who reduces the throttle and informs the crew to wait to react to the condition. When the bank angle is approximately 45 deg, the instructor pilot informs the pilot-in-training to recover by using appropriate recovery techniques. After recovery, normal thrust is restored.

#### Initial Conditions

Altitude:	1000 ft above ground level and climbing.
Center of gravity:	Midrange.
Airspeed:	Second segment climb airspeed.
Autopilot:	Engaged.
Autothrottle:	Engaged.
Thrust:	As required.
Target parameters:	45-deg bank angle. Autopilot and autothrottle engaged. Minimum of 1000 ft above ground level.

### Exercise 3. Instructions for the Simulator Instructor

1. Establish initial conditions.
2. Maintain thrust on other engine(s). Instructor may have to hold throttle in idle against autothrottle commands until recovery initiated. In certain envelope protected airplanes, certain features may have to be disabled to allow this scenario to work.
3. Have the pilot-in-training observe the developing yaw and roll condition and decreasing airspeed.
4. Upon passing 45 deg of bank, instruct the pilot-in-training to recover by assessing the energy, disengaging the autopilot and autothrottle, and applying appropriate recovery techniques. Roll control may require as much as full aileron and spoiler input and use of coordinated rudder.
5. After recovery, normal thrust is used and training continues.

**Common Instructor Pilot Errors**

- a. Autopilot and autothrottle are not engaged at 1000 ft above ground level.
- b. Has the pilot-in-training initiate recovery before allowing the autopilot to fly to 45 deg of bank angle.

**Common Pilot-in-Training Errors**

- a. Forgets to disengage the autopilot or autothrottle.
- b. Fails to unload.
- c. Fails to use full control inputs.
- d. Fails to complete the recovery before ground impact.

**Common Student Errors**

- a. Student fails to/or is slow to disconnect autopilot and autothrottle.
- b. Student fails to use full roll control during recovery.
- c. Student fails to manage pitch during roll upset, resulting in ground contact or approach to stall.
- d. Student fails to input rudder after recovery for asymmetric thrust condition.



### Exercise 4. High Altitude Stall Warning

<p><b>Lesson:</b> High Altitude Stall Warning</p> <p><b>Lesson Type:</b> Train to Proficiency</p> <p><b>Minimum Device:</b> Full Flight Simulator</p>	<p><b>Performance Package:</b> TBD</p> <p><b>Pre-Brief Time:</b> TBD</p> <p><b>Preparation Time:</b> TBD</p> <p><b>Sim Time:</b> TBD</p> <p><b>Preparations Time:</b> TBD</p> <p><b>De-Brief Time:</b> TBD</p>
<p><b>Introduction:</b></p>	<p>The purpose of this LOFT training aid is to assist operators of high altitude jet airplanes. The high altitude slowdown to an approach to stall represents a threat that has resulted in accidents and incidents when mismanaged. This simulator training is to assist crews in managing this threat. The exercise is not intended to train an actual jet upset or full stall, it only has the airplane reach the indications of an approach to stall before a recovery is initiated. Operators should consider a number of factors to determine how realistic their simulator will respond to this training scenario. Operators should determine the optimum manner to set up this scenario to achieve the goals of the training.</p>
<p><b>Goals of Training:</b></p>	<ol style="list-style-type: none"> <li>1. Reinforce understanding of applicable high altitude characteristics</li> <li>2. Assess how to determine cruise altitude capability</li> <li>3. Reinforce acceptable climb techniques and acknowledge the risks associated with various climb scenarios and in particular vertical speed</li> <li>4. Recognize cues of an approach to stall and indications observable prior to that point</li> <li>5. Discuss automation factors such as mode protections, hazards of split automation (where either autopilot or autothrottle is disconnected) and inappropriate modes</li> <li>6. Address intuitive and incorrect reactions to stall warning indications</li> <li>7. Develop procedures that are widely accepted to recover from impending high altitude stall conditions with and without auto-flight systems</li> </ol>
<p><b>Introductory Notes:</b></p>	<p>The crew begins this lesson in cruise flight with an airplane at an altitude of FL250 or above in a near maximum altitude situation. The airplane weight should be at or near the maximum for that altitude based upon company or manufacturer's procedures. The crew should discuss performance capability and reference applicable resources to determine what the maximum altitude is for the weight and environmental conditions. These references could include cruise charts, FMS optimum and FMS maximum altitudes with various mode protections (lateral and vertical) available. Buffet margins should be referenced and discussed based on the altitude. Alternative climbing modes and their associated hazards should be understood. Common errors include complacency with climb and cruise procedures as well as a lack of knowledge with cruise charts.</p>

**Setup and Limitations:**

The simulator will then be either positioned or flown inappropriately to a situation where with an increase in ISA temperature will cause the airplane to be behind the power curve due to changing ambient conditions. The early addition of maximum available thrust should be discussed as a necessity to prevent this situation from occurring. However, in this situation maximum thrust is not enough to keep from slowing down while maintaining altitude. Certain airplane features, either with automation or without, may prevent an approach to stall from occurring. However, indications of such an impending situation should be discussed. These include airspeed trends, symbology/warning changes, low speed indications, trim changes, etc. Auto thrust or autopilot may have to be disconnected to provide the approach to stall indications, but the goal should be to keep those modes in operation if possible to simulate a real scenario. Instructors should discuss the system degradation that results in this situation and the associated hazards. If unable to produce desired effect, reducing thrust may be necessary.

**Recognition and Recovery**

Brief interactive discussions of impending stall warning recovery methods followed by an actual stall warning recovery. Instructors should ensure the crews recover at the first indication of an approach to stall (mode reversion, aural; shaker, pusher warnings, buffet, etc). Do not allow the airplane to stall or the situation to progress to an upset situation because simulator realism may be compromised in this condition. Emphasis should be placed that the recovery requires maximum thrust and the reduction of pitch to lower the angle of attack and allowing the airplane to accelerate. At these altitudes and weight/temperature combinations, a descent will be required. If the autoflight systems are used, appropriate modes should be used that meet the objectives of maximum thrust and a smooth decrease in pitch and a descent to an appropriate altitude that allows acceleration to normal and sustainable cruise speed. If manual flight is used, smooth control inputs avoiding abrupt control actions and maximum thrust are necessary. Pilots should be aware that with the increased true airspeed larger changes will occur for the same amount of pitch change as used at lower altitudes. Common errors include incorrect recovery technique. Repeat scenario as necessary time permitting.

The crew begins this lesson in cruise flight with an airplane at an altitude of FL250 or above. The airplane weight should be at or near the maximum for that altitude based upon company or manufacturer’s procedures. Ensure crew references applicable cruise charts to determine what the maximum altitude is for the weight and environmental conditions. IOS: Instructor operating system or simulator control panel

1. IOS»POSITION SET»FL 250 or ABOVE
2. IOS»AIRPLANE SET»  
Gross weight: MAX appropriate
3. IOS»ENVIRONMENT SET»  
Weather: As desired  
DAY or NIGHT  
29.92 or STANDARD  
Winds: As desired  
OAT»ISA or as initially required for scenario

Element	Information / Check for
<b>Cruise Flight</b>	<ul style="list-style-type: none"> <li>• Ask crew if they can take the next higher flight level (take note of VNAV max altitude)</li> <li>• Review the use of vertical speed/ other climb modes in climbs and what are the caveats</li> <li>• Ensure crew understands how to determine MAX cruise altitude from Flight Management System (if applicable) as well as supporting documents or manuals (e.g. Performance Manual, QRH, FCOM, etc.)</li> <li>• Ensure crew understands what their buffet margin is for the current altitude and weight combination.</li> <li>• Review different scenarios leading to high altitude stalls and upset conditions. For each scenario, review recovery procedures.</li> <li>• Set or maneuver simulator to situation that is behind the power curve such that a slowdown will occur regardless of thrust setting, with increased ISA</li> </ul>
IOS» Take a “snap shot” or save the current phase and position of flight if available to permit repetition of conditions and training	
IOS»Increase OAT as appropriate to simulate flight into warmer conditions	
<b>Airspeed Decay</b>	<ul style="list-style-type: none"> <li>• Ask crew to disengage auto thrust (only if applicable/required).</li> <li>• Instructor may have remove power from certain aircraft specific systems (e.g. flight computers) to permit aircraft to encounter a stall warning. Autopilot use may be lost.</li> <li>• Instructor may have to set thrust that produces, along with temperature increase, a slow loss in airspeed.</li> <li>• Explain to crew how the aircraft reacts with the Autopilot on and its attempt to maintain altitude.</li> <li>• Point out airspeed trend and instrument indications (low speed indications/symbolology if applicable)</li> <li>• Explain what the aircraft specific threats that will be encountered with various automation situations (split automation, LNAV vs. heading select modes, etc.)</li> </ul>
<b>Stall Warning</b>	<ul style="list-style-type: none"> <li>• Explain to crew what the stall warning system uses to set off warning and in what progression the alerts will take place (visual, aural, shaker, pusher, buffet, etc.).</li> <li>• Make sure crew understands that recovery will begin at first level of warning.</li> </ul>

<b>Recovery (Autoflight)</b>	<ul style="list-style-type: none"> <li>• Crew should command a desirable (down) vertical speed into the auto-flight system. E.g. (-1000ft/min)</li> <li>• Speed should be crew selected to avoid any thrust reduction by auto-flight system</li> <li>• Ensure thrust DOES NOT reduce to idle or below desired setting</li> <li>• Monitor TCAS and SCAN for traffic conflicts</li> <li>• Notify ATC</li> <li>• Crew should determine appropriate new cruising altitude (a descent of at least 1000 feet is recommended to achieve adequate acceleration).</li> </ul>
<b>Recovery (Manual)</b>	<ul style="list-style-type: none"> <li>• Crew should disengage auto-flight systems (if applicable)</li> <li>• Pitch aircraft down smoothly to establish descent, AVOID ABRUPT CONTROL INPUTS, Pilots should be aware that with the increased true airspeed larger changes will occur for the same amount of pitch change as used at lower altitudes</li> <li>• Set thrust to MAX (MAX appropriate to aircraft)</li> <li>• Accelerate to appropriate airspeed</li> <li>• Monitor TCAS and SCAN for traffic conflicts</li> <li>• Notify ATC</li> <li>• Crew should determine appropriate new cruising altitude</li> </ul>

### Recurrent Training Exercises

The pilot-in-training should be given the opportunity to review the airplane handling characteristics. Those events identified as pre-exercise practice are appropriate for this review. The length of review should depend on pilot-in-training experience and skill level.

Recurrent upset training should be given as non-jeopardy training and not be evaluated. The unique variations of each individual situation a pilot starts a recovery from, and the wide variations in successful recoveries, make evaluations difficult to measure. Furthermore, variations in simulator fidelity make measures not accurate and quite difficult on both a qualitative and quantitative basis. Upset recurrent training should emphasize recognition and skill development.

Recurrent training should incorporate a nose-high situation. This situation can be induced by the pilot-in-training, or by the pilot-not-flying (PNF) (with

perhaps the pilot-in-training closing his or her eyes to force an assessment of the situation and energy), or by conditions available to the instructor by the use of simulator engineering. The pilot-in-training should recover by using appropriate techniques discussed in the initial training.

Recurrent training should incorporate a nose-low, high-bank-angle situation. This situation can be induced by the pilot-in-training, or by the PNF (with perhaps the pilot-in-training closing his or her eyes to force an assessment of the situation and energy), or by conditions available to the instructor by the use of simulator engineering. The pilot-in-training should recover by using appropriate techniques discussed in initial training.



# Pilot Guide to Airplane Upset Recovery Questions

## 3-A

Included in the following appendix are questions designed to test a pilot's knowledge of the material contained in the "Pilot Guide to Airplane Upset Recovery." The questions are all multiple choice.

The first part of this appendix is the Pilot-in-Training Examination. Instructions for answering the questions are provided.

The second part of this appendix is the Instructor Examination Guide. This part contains the questions in the Pilot-in-Training Examination, the correct answers to each question, and the section in the "Pilot Guide to Airplane Upset Recovery" where the correct answer may be found.

## Table of Contents

<b>Section</b>	<b>Page</b>
Pilot-in-Training Examination .....	App. 3-A.3
Instructor Examination Guide .....	App. 3-A.15
Summary of Answers .....	App. 3-A.31



## Pilot-in-Training Examination

### Instructions

These questions are based on the material in the “Pilot Guide to Airplane Upset Recovery.” The answer to each question can be found in that section. The questions are all multiple choice. Circle the one answer to each question that is most correct.

### Questions

- The predominant number of airplane upsets are caused by:  
 a. Environmental factors.  
 b. Airplane system anomalies.  
 c. Pilot-induced factors.
- Most of the multiengine turbojet loss-of-control incidents that are caused by environmental factors are because of:  
 a. Microbursts.  
 b. Windshear.  
 c. Airplane icing.  
 d. Wake turbulence.
- Technology in modern airplanes reduces the flight crew workload. Therefore, while initiating the recovery from an airplane upset, the pilot should:  
 a. Verify that the autopilot and autothrottles are still engaged.  
 b. Engage the autopilot and autothrottles, if disengaged.  
 c. Reduce the level of automation by disengaging the autopilot and autothrottles.  
 d. Ask the other pilot “What is it doing now?”
- Which of the following statements regarding energy is true?  
 a. Kinetic energy decreases with increasing airspeed.  
 b. Potential energy is approximately proportional to airspeed.  
 c. Chemical energy remains constant throughout a flight.  
 d. Kinetic energy can be traded for potential energy, and potential energy can be traded for kinetic energy.
- The objective in maneuvering the airplane is to manage energy so that:  
 a. Kinetic energy stays between limits (stall and placards).  
 b. Potential energy stays between limits (terrain to buffet altitude).  
 c. Chemical energy stays above certain thresholds (not running out of fuel).  
 d. All of the above.
- The airplane angle of attack is the angle between the airplane longitudinal axis and the oncoming air.  
 a. True.  
 b. False.
- Exceed the critical angle of attack and the surface will stall, and lift will decrease instead of increasing. This is true:  
 a. Unless the airplane is in a nosedown pitch attitude.  
 b. Only if the airspeed is low.  
 c. Only if the airplane is in a nose-high pitch attitude.  
 d. Regardless of airplane speed or attitude.





8. The angle of attack at which a wing stalls reduces with \_\_\_\_\_ Mach.  
\_\_\_\_ a. Decreasing.  
\_\_\_\_ b. Increasing.
9. Airplane stall speeds are published in the Approved Flight Manual for each airplane model. These speeds are presented as a function of airplane weight. Therefore, if a pilot maintains airspeed above the appropriate speed listed for the airplane weight, the airplane will not stall.  
\_\_\_\_ a. True.  
\_\_\_\_ b. False.
10. Large downward aileron deflections:  
\_\_\_\_ a. Could induce air separation over that portion of the wing at very high angles of attack.  
\_\_\_\_ b. Should never be used when recovering from an airplane upset.  
\_\_\_\_ c. Are more effective at high angles of attack.
11. Dihedral is the positive angle formed between the lateral axis of an airplane and a line that passes through the center of the wing. Which of the following statements is *incorrect*?  
\_\_\_\_ a. Dihedral contributes to airplane lateral stability.  
\_\_\_\_ b. The term “dihedral effect” is used when describing the effects of wing sweep and rudder on lateral stability.  
\_\_\_\_ c. A wing with dihedral will develop stable rolling moments with sideslip.  
\_\_\_\_ d. If the relative wind comes from the side of an airplane that has dihedral-designed wings, the wing into the wind is subject to a decrease in lift.
12. Rudders on modern jet transport airplanes are usually designed and sized to:  
\_\_\_\_ a. Create large sideslip capability during recovery from stall.  
\_\_\_\_ b. Counter yawing moment associated with an engine failure at very low takeoff speeds.  
\_\_\_\_ c. Counter rolling moment created by ailerons and spoilers.
13. While already at high speed, what happens if Mach is allowed to increase?  
\_\_\_\_ a. Airflow over parts of the airplane begins to exceed the speed of sound.  
\_\_\_\_ b. Shock waves can cause local airflow separation.  
\_\_\_\_ c. Characteristics such as pitchup, pitchdown, or buffeting may occur.  
\_\_\_\_ d. All of the above.
14. Positive static stability is defined as the initial tendency to return to an initial undisturbed state after a disturbance.  
\_\_\_\_ a. True.  
\_\_\_\_ b. False.
15. Movement about the airplane lateral axis is called:  
\_\_\_\_ a. Yaw.  
\_\_\_\_ b. Roll.  
\_\_\_\_ c. Pitch.  
\_\_\_\_ d. Sideslip.
16. Which of the following statements is always true?  
\_\_\_\_ a. Weight points 90 deg from the airplane longitudinal axis.  
\_\_\_\_ b. Lift must always be aligned with the center of gravity.  
\_\_\_\_ c. Weight always points to the center of the Earth.  
\_\_\_\_ d. The center of gravity never changes in flight.



17. If the engines are not aligned with the airplane center of gravity, a change in engine thrust will:
- a. Have no effect on pitching moment.
  - b. Be accompanied by a change in pitching moment.
18. To maintain altitude in a banked turn, the lift produced by the airplane must be:
- a. Greater than the airplane weight, and the amount is a function of bank angle.
  - b. Greater than the airplane weight, and the amount is a function of altitude.
  - c. Equal to the weight of the airplane.
19. During lateral maneuvering, aileron and spoiler effectiveness:
- a. Increases with increasing angle of attack.
  - b. Decreases with increasing angle of attack.
  - c. Is a function of the airplane's inertia about its vertical axis.
20. Which of the following statements about recovering from large airplane bank angles is true?
- a. The effect of up-elevator is to tighten the turn.
  - b. The bank should be reduced to near level before initiating aggressive pitch maneuvering.
  - c. The lift vector should be oriented away from the gravity vector.
  - d. All of the above.
  - e. Only answers a and b.
21. If a pilot inputs full rudder in a normal symmetric airplane situation, it will result in very large sideslip angles and large structural loads.
- a. True.
  - b. False.
22. Stability in the vertical axis tends to drive the sideslip angle toward zero. The most dynamic stability about the vertical axis on modern jet transports is from:
- a. The vertical fin.
  - b. The rudder.
  - c. An active stability augmentation system/yaw damper.
  - d. Pilot roll input.
23. With insufficient aerodynamic forces acting on the airplane (airplane stalled), its trajectory will be mostly ballistic and it may be difficult for the pilot to command a change in attitude until:
- a. Full noseup elevator is applied.
  - b. Full rudder input is applied.
  - c. Gravity effect on the airplane produces enough airspeed when the angle of attack is reduced.
  - d. Arriving at a lower altitude.
24. During a situation where the high-speed limitation is exceeded, recovery actions should be careful and prompt and may include:
- a. Orienting the lift vector away from the gravity vector.
  - b. Reducing thrust.
  - c. Adding drag.
  - d. All of the above.



25. Which of the following statements regarding recovering from an airplane upset are correct?
- a. The actions should be correct and timely.
  - b. Troubleshooting the cause of the upset is secondary to initiating recovery.
  - c. Regaining and maintaining control of the airplane is paramount.
  - d. All of the above.
26. A good analysis process of an airplane upset should include:
- a. Locating the bank indicator.
  - b. Determining the pitch attitude.
  - c. Confirming attitude by referring to other indicators.
  - d. Assessing the airplane energy.
  - e. All of the above.
27. During recovery from an airplane upset:
- a. Pilots must be very careful to maintain at least 1-g force.
  - b. Altitude should always be maintained.
  - c. Training and experience gained from one airplane may always be transferred to another.
  - d. Pilots must be prepared to use full control authority.
28. A stall is usually accompanied by a continuous stall warning, and it is characterized by:
- a. Buffeting, which could be heavy.
  - b. A lack of pitch authority.
  - c. A lack of roll authority.
  - d. The inability to arrest descent rate.
  - e. All of the above.
29. Which of the following statements is true?
- a. A stall is a controlled situation.
  - b. An approach to stall warning is an uncontrolled situation.
  - c. Recovery from approach to stall warning is the same as recovery from a stall.
  - d. To recover from a nose-low stall, angle of attack must be reduced.
30. When initiating recommended airplane upset recovery techniques, the first two techniques are
- a. Maintain altitude and apply additional thrust.
  - b. Reduce the angle of attack and maneuver toward wings level.
  - c. Recognize and confirm the situation and disengage the autopilot and autothrottles.
  - d. Determine the malfunction and disengage the autopilot and autothrottles.
31. In a nose-high, wings-level airplane upset, after accomplishing the first two recommended techniques:
- a. Apply up to full nosedown elevator and consider trimming off some control force.
  - b. Immediately roll into a 60-deg bank.
  - c. Maintain at least 1-g force.
  - d. Immediately establish sideslip in order to maintain at least 1-g force.



32. In a nose-high, wings-level airplane upset, when it is determined that rudder input is required because roll input is ineffective:
- a. Only a small amount should be used.
  - b. Do not apply rudder too quickly.
  - c. Do not hold rudder input too long.
  - d. Improper use of rudder may result in loss of lateral and directional control.
  - e. Extreme caution must be used because of the low-energy situation.
  - f. All of the above.
33. During recovery from a nose-low, wings-level, high-air-speed airplane upset:
- a. The airplane cannot be stalled.
  - b. Use of stabilizer trim is always optional, but never required.
  - c. The recovery is completed by establishing a pitch, thrust, and airplane configuration that corresponds to the desired airspeed.
34. During recovery from a nose-low, high-bank-angle airplane upset:
- a. If 90 deg of bank is exceeded, continue the roll to wings level.
  - b. It may be necessary to unload the airplane by decreasing backpressure.
  - c. Increase elevator backpressure while beginning to roll toward wings level.
35. When should an upset recovery be initiated?
- a. Only when pitch or bank reaches specified limit values.
  - b. Only when the airspeed is rapidly decreasing (increasing).
  - c. Whenever an unintentional excessive divergence from the intended flight path and/or airspeed occurs.
36. Pilot induced oscillations are:
- a. Oscillations due to cyclic actions on the controls by the pilot, with an immediate reaction of the airplane in the same direction.
  - b. Oscillations due to cyclic action on the controls by the pilot, with an out-of-phase airplane response.
  - c. Oscillations due to a rudder and aileron out of trim condition.
37. In the event of thrust asymmetry at takeoff:
- a. The pilot must know how much rudder trim is needed in advance.
  - b. The pilot must react with a predefined amount of rudder.
  - c. The pilot must apply an amount of rudder determined by the yawing moment in order to eliminate the sideslip.
38. The rudder is used:
- a. To control yaw.
  - b. To damp Dutch roll in case of a yaw damper system failure.
  - c. To induce roll if normal roll control is lost/ineffective.
  - d. a and c
39. Cyclic abrupt rudder pedal inputs can:
- a. Cause structural damage above  $V_A$ .
  - b. Cause structural damage below  $V_A$ .
  - c. Not cause structural damage below  $V_A$ .
  - d. a and b





40. The role of rudder limiters is:
- a. To allow full rudder pedal input in one direction regardless of speed, while ensuring required rudder efficiency.
  - b. To allow any succession of rudder inputs below  $V_A$ .
  - c. To ensure structural consideration, but limits the required rudder efficiency at high speed (above  $V_A$ ).
41. Configuration maneuvering speed:
- a. Provides a structural protection to slats/flaps while flying for extended periods.
  - b. Defines the minimum speed that the airplane can be flown at in a given configuration.
  - c. Defines the minimum speed that ensures a  $1.2V_s$  margin.
42. When operating at a constant airspeed with constant thrust setting at high altitude (typically above FL250) in slow flight below L/D max airspeed, any disturbance causing a decrease in airspeed will result in a further decrease in airspeed unless thrust is increased. High altitude recovery from slow flight while turning is best accomplished by:
- a. Increasing thrust to arrest the slowdown.
  - b. Increasing thrust to accelerate to airspeed above L/D max speed.
  - c. Increasing thrust to maximum available thrust and reducing bank angle while accelerating to airspeed above L/D max speed. In a thrust limited situation, exiting slow flight will require an immediate descent as an aerodynamic stall is imminent.
  - d. All of the above
  - e. None of the above
43. Maximum Altitude is the highest altitude at which an airplane can be operated. In today's modern airplanes it is determined by basic characteristics unique to each airplane model. Maximum Altitude for an airplane is:
- a. Maximum Certified Altitude – the altitude determined during certification set by the pressurization structural load limits on the fuselage.
  - b. Thrust Limited Altitude – the altitude at which sufficient thrust is available to provide a specific minimum rate of climb.
  - c. Buffet or Maneuver Limited Altitude – the altitude at which a specific maneuver margin exists prior to buffet onset.
  - d. The highest of the above listed altitudes.
  - e. The lowest of the above listed altitudes.
44. At high altitude, an aft loaded airplane will:
- a. Be more responsive to control pressures since it is less stable than a forward loading.
  - b. Be less responsive to control pressures as there is a longer moment arm from the center of gravity to the tail assembly.
  - c. Just as sensitive to control pressures as a forward loaded aircraft. Center of gravity positioning is insignificant to handling qualities in modern jet aircraft.



## Instructor Examination Guide

### Instructions

This guide contains questions based on the material in the “Pilot Guide to Airplane Upset Recovery.” The answer to each question can be found in that section. The questions are all multiple choice. There is one answer to each question that is most correct.

The correct answer is listed after each question, along with the section in the “Pilot Guide to Airplane Upset Recovery” where the correct answer may be found.

### Questions

1. The predominant number of airplane upsets are caused by:  
 a. Environmental factors.  
 b. Airplane system anomalies.  
 c. Pilot-induced factors.

*Answer: a. (Section 2.4.1).*

2. Most of the multiengine turbojet loss-of-control incidents that are caused by environmental factors are because of:  
 a. Microbursts.  
 b. Windshear.  
 c. Airplane icing.  
 d. Wake turbulence.

*Answer: d. (Section 2.4.1)*

3. Technology in modern airplanes reduces the flight crew workload. Therefore, while initiating the recovery from an airplane upset, the pilot should:  
 a. Verify that the autopilot and autothrottles are still engaged.  
 b. Engage the autopilot and autothrottles, if disengaged.  
 c. Reduce the level of automation by disengaging the autopilot and autothrottles.  
 d. Ask the other pilot “What is it doing now?”

*Answer: c. (Section 2.4.4)*

4. Which of the following statements regarding energy is true?  
 a. Kinetic energy decreases with increasing airspeed.  
 b. Potential energy is approximately proportional to airspeed.  
 c. Chemical energy remains constant throughout a flight.  
 d. Kinetic energy can be traded for potential energy, and potential energy can be traded for kinetic energy.

*Answer: d. (Section 2.5.2)*

5. The objective in maneuvering the airplane is to manage energy so that:  
 a. Kinetic energy stays between limits (stall and placards).  
 b. Potential energy stays between limits (terrain to buffet altitude).  
 c. Chemical energy stays above certain thresholds (not running out of fuel).  
 d. All of the above.

*Answer: d. (Section 2.5.2)*



6. The airplane angle of attack is the angle between the airplane longitudinal axis and the oncoming air.
- a. True.
  - b. False.

**Answer: a. (Section 2.5.5.1)**

7. Exceed the critical angle of attack and the surface will stall, and lift will decrease instead of increasing. This is true:
- a. Unless the airplane is in a nosedown pitch attitude.
  - b. Only if the airspeed is low.
  - c. Only if the airplane is in a nose-high pitch attitude.
  - d. Regardless of airplane speed or attitude.

**Answer: d. (Section 2.5.5.1)**

8. The angle of attack at which a wing stalls reduces with \_\_\_\_\_ Mach.
- a. Decreasing.
  - b. Increasing.

**Answer: b. (Section 2.5.5.1).**

9. Airplane stall speeds are published in the Approved Flight Manual for each airplane model. These speeds are presented as a function of airplane weight. Therefore, if a pilot maintains airspeed above the appropriate speed listed for the airplane weight, the airplane will not stall.
- a. True.
  - b. False.

**Answer: b. (Section 2.5.5.1).**

10. Large downward aileron deflections:
- a. Could induce air separation over that portion of the wing at very high angles of attack.
  - b. Should never be used when recovering from an airplane upset.
  - c. Are more effective at high angles of attack.

**Answer: a. (Section 2.5.5.3).**

11. Dihedral is the positive angle formed between the lateral axis of an airplane and a line that passes through the center of the wing. Which of the following statements is *incorrect*?
- a. Dihedral contributes to airplane lateral stability.
  - b. The term “dihedral effect” is used when describing the effects of wing sweep and rudder on lateral stability.
  - c. A wing with dihedral will develop stable rolling moments with sideslip.
  - d. If the relative wind comes from the side of an airplane that has dihedral-designed wings, the wing into the wind is subject to a decrease in lift.

**Answer: d. (Section 2.5.5.4.2).**



12. Rudders on modern jet transport airplanes are usually designed and sized to:
- a. Create large sideslip capability during recovery from stall.
  - b. Counter yawing moment associated with an engine failure at very low takeoff speeds.
  - c. Counter rolling moment created by ailerons and spoilers.

**Answer: b. (Section 2.5.5.4.3).**

13. While already at high speed, what happens if Mach is allowed to increase?
- a. Airflow over parts of the airplane begins to exceed the speed of sound.
  - b. Shock waves can cause local airflow separation.
  - c. Characteristics such as pitchup, pitchdown, or buffeting may occur.
  - d. All of the above.

**Answer: d. (Section 2.5.5.5).**

14. Positive static stability is defined as the initial tendency to return to an initial undisturbed state after a disturbance.
- a. True.
  - b. False.

**Answer: a. (Section 2.5.5.6).**

15. Movement about the airplane lateral axis is called:
- a. Yaw.
  - b. Roll.
  - c. Pitch.
  - d. Sideslip.

**Answer: c. (Section 2.5.5.7).**

16. Which of the following statements is always true?
- a. Weight points 90 deg from the airplane longitudinal axis.
  - b. Lift must always be aligned with the center of gravity.
  - c. Weight always points to the center of the Earth.
  - d. The center of gravity never changes in flight.

**Answer: c. (Section 2.5.5.7).**

17. If the engines are not aligned with the airplane center of gravity, a change in engine thrust will:
- a. Have no effect on pitching moment.
  - b. Be accompanied by a change in pitching moment.

**Answer: b. (Section 2.5.5.7)**

18. To maintain altitude in a banked turn, the lift produced by the airplane must be:
- a. Greater than the airplane weight, and the amount is a function of bank angle.
  - b. Greater than the airplane weight, and the amount is a function of altitude.
  - c. Equal to the weight of the airplane.

**Answer: a. (Section 2.5.5.7).**





19. During lateral maneuvering, aileron and spoiler effectiveness:
- a. Increases with increasing angle of attack.
  - b. Decreases with increasing angle of attack.
  - c. Is a function of the airplane's inertia about its vertical axis.

**Answer: b. (Section 2.5.5.9).**

20. Which of the following statements about recovering from large airplane bank angles is true?
- a. The effect of up-elevator is to tighten the turn.
  - b. The bank should be reduced to near level before initiating aggressive pitch maneuvering.
  - c. The lift vector should be oriented away from the gravity vector.
  - d. All of the above.
  - e. Only answers a and b.

**Answer: d. (Section 2.5.5.8).**

21. If a pilot inputs full rudder in a normal symmetric airplane situation, it will result in very large sideslip angles and large structural loads.
- a. True.
  - b. False.

**Answer: a. (Section 2.5.5.10).**

22. Stability in the vertical axis tends to drive the sideslip angle toward zero. The most dynamic stability about the vertical axis on modern jet transports is from:
- a. The vertical fin.
  - b. The rudder.
  - c. An active stability augmentation system/yaw damper.
  - d. Pilot roll input.

**Answer: c. (Section 2.5.5.10).**

23. With insufficient aerodynamic forces acting on the airplane (airplane stalled), its trajectory will be mostly ballistic and it may be difficult for the pilot to command a change in attitude until:
- a. Full noseup elevator is applied.
  - b. Full rudder input is applied.
  - c. Gravity effect on the airplane produces enough airspeed when the angle of attack is reduced.
  - d. Arriving at a lower altitude.

**Answer: c. (Section 2.5.5.11)**

24. During a situation where the high-speed limitation is exceeded, recovery actions should be careful and prompt and may include:
- a. Orienting the lift vector away from the gravity vector.
  - b. Reducing thrust.
  - c. Adding drag.
  - d. All of the above.

**Answer: d. (Section 2.5.5.11)**



25. Which of the following statements regarding recovering from an airplane upset are correct?
- a. The actions should be correct and timely.
  - b. Troubleshooting the cause of the upset is secondary to initiating recovery.
  - c. Regaining and maintaining control of the airplane is paramount.
  - d. All of the above.

**Answer: d. (Section 2.6.1)**

26. A good analysis process of an airplane upset should include:
- a. Locating the bank indicator.
  - b. Determining the pitch attitude.
  - c. Confirming attitude by referring to other indicators.
  - d. Assessing the airplane energy.
  - e. All of the above.

**Answer: e. (Section 2.6.1).**

27. During recovery from an airplane upset:
- a. Pilots must be very careful to maintain at least 1-g force.
  - b. Altitude should always be maintained.
  - c. Training and experience gained from one airplane may always be transferred to another.
  - d. Pilots must be prepared to use full control authority.

**Answer: d. (Section 2.6.6.2, 3, 5).**

28. A stall is usually accompanied by a continuous stall warning, and it is characterized by:
- a. Buffeting, which could be heavy.
  - b. A lack of pitch authority.
  - c. A lack of roll authority.
  - d. The inability to arrest descent rate.
  - e. All of the above.

**Answer: e. (Section 2.6.3).**

29. Which of the following statements is true?
- a. A stall is a controlled situation.
  - b. An approach to stall warning is an uncontrolled situation.
  - c. Recovery from approach to stall warning is the same as recovery from a stall.
  - d. To recover from a nose-low stall, angle of attack must be reduced.

**Answer: d. (Section 2.6.3).**

30. When initiating recommended airplane upset recovery techniques, the first two techniques are:
- a. Maintain altitude and apply additional thrust.
  - b. Reduce the angle of attack and maneuver toward wings level.
  - c. Recognize and confirm the situation and disengage the autopilot and autothrottles.
  - d. Determine the malfunction and disengage the autopilot and autothrottles.

**Answer: c. (Section 2.6.3.1, 2, 3).**



31. In a nose-high, wings-level airplane upset, after accomplishing the first two recommended techniques:
- a. Apply up to full nosedown elevator and consider trimming off some control force.
  - b. Immediately roll into a 60-deg bank.
  - c. Maintain at least 1-g force.
  - d. Immediately establish sideslip in order to maintain at least 1-g force.

**Answer: a. (Section 2.6.3.1).**

32. In a nose-high, wings-level airplane upset, when it is determined that rudder input is required because roll input is ineffective:
- a. Only a small amount should be used.
  - b. Do not apply rudder too quickly.
  - c. Do not hold rudder input too long.
  - d. Improper use of rudder may result in loss of lateral and directional control.
  - e. Extreme caution must be used because of the low-energy situation.
  - f. All of the above.

**Answer: f. (Section 2.6.3.1).**

33. During recovery from a nose-low, wings-level, high-air-speed airplane upset:
- a. The airplane cannot be stalled.
  - b. Use of stabilizer trim is always optional, but never required.
  - c. The recovery is completed by establishing a pitch, thrust, and airplane configuration that corresponds to the desired airspeed.

**Answer: c. (Section 2.6.3.2).**

34. During recovery from a nose-low, high-bank-angle airplane upset:
- a. If 90 deg of bank is exceeded, continue the roll to wings level.
  - b. It may be necessary to unload the airplane by decreasing backpressure.
  - c. Increase elevator backpressure while beginning to roll toward wings level.

**Answer: b. (Section 2.6.3.3).**

35. When should an upset recovery be initiated?
- a. Only when pitch or bank reaches specified limit values.
  - b. Only when the airspeed is rapidly decreasing (increasing).
  - c. Whenever an unintentional excessive divergence from the intended flight path and/or airspeed occurs.

**Answer: c. (Section 2.2).**

36. Pilot induced oscillations are:
- a. Oscillations due to cyclic actions on the controls by the pilot, with an immediate reaction of the airplane in the same direction.
  - b. Oscillations due to cyclic action on the controls by the pilot, with an out-of-phase airplane response.
  - c. Oscillations due to a rudder and aileron out-of-trim condition.

**Answer: b. (Section 2.4.3.8).**



37. In the event of thrust asymmetry at takeoff:
- a. The pilot must know how much rudder trim is needed in advance.
  - b. The pilot must react with a predefined amount of rudder.
  - c. The pilot must apply an amount of rudder determined by the yawing moment in order to eliminate the sideslip.

**Answer: c. (Section 2.5.5.4.3).**

38. The rudder is used:
- a. To control yaw.
  - b. To damp dutch roll in case of a yaw damper system failure.
  - c. To induce roll if normal roll control is lost/ineffective.
  - d. a and c

**Answer: d. (Section 2.5.5.10).**

39. Cyclic abrupt rudder pedal inputs can:
- a. Cause structural damage above  $V_A$ .
  - b. Cause structural damage below  $V_A$ .
  - c. Not cause structural damage below  $V_A$ .
  - d. a and b

**Answer: d. (Section 2.5.5.12).**

40. The role of rudder limiters is:
- a. To allow full rudder pedal input in one direction regardless of speed, while ensuring required rudder efficiency.
  - b. To allow any succession of rudder inputs below  $V_A$ .
  - c. To ensure structural consideration, but limits the required rudder efficiency at high speed (above  $V_A$ ).

**Answer: a. (Section 2.5.5.10).**

41. Configuration maneuvering speed:
- a. Provides a structural protection to slats/flaps while flying for extended periods.
  - b. Defines the minimum speed that the airplane can be flown at in a given configuration.
  - c. Defines the minimum speed that ensures a  $1.2V_S$  margin.

**Answer: b. (Section 2.5.3).**





42. When operating at a constant airspeed with constant thrust setting at high altitude (typically above FL250) in slow flight below L/D max airspeed, any disturbance causing a decrease in airspeed will result in a further decrease in airspeed unless thrust is increased. High altitude recovery from slow flight while turning is best accomplished by:
- a. Increasing thrust to arrest the slowdown.
  - b. Increasing thrust to accelerate to airspeed above L/D max speed.
  - c. Increasing thrust to maximum available thrust and reducing bank angle while accelerating to airspeed above L/D max speed. In a thrust limited situation, exiting slow flight will require an immediate descent as an aerodynamic stall is imminent.
  - d. All of the above
  - e. None of the above

**Answer: c. (Section 2.5.5.11.2.5).**

43. Maximum Altitude is the highest altitude at which an airplane can be operated. In today's modern airplanes it is determined by basic characteristics unique to each airplane model. Maximum Altitude for an airplane is:
- a. Maximum Certified Altitude – the altitude determined during certification set by the pressurization structural load limits on the fuselage.
  - b. Thrust Limited Altitude – the altitude at which sufficient thrust is available to provide a specific minimum rate of climb.
  - c. Buffet or Maneuver Limited Altitude – the altitude at which a specific maneuver margin exists prior to buffet onset.
  - d. The highest of the above listed altitudes.
  - e. The lowest of the above listed altitudes.

**Answer: e. (Section 2.5.5.11.2.6).**

44. At high altitude, an aft loaded airplane will:
- a. Be more responsive to control pressures since it is less stable than a forward loading.
  - b. Be less responsive to control pressures as there is a longer moment arm from the center of gravity to the tail assembly.
  - c. Just as sensitive to control pressures as a forward loaded aircraft. Center of gravity positioning is insignificant to handling qualities in modern jet aircraft.

**Answer: a. (Section 2.5.5.11.3).**



**Summary of Answers**

1. a
2. d
3. c
4. d
5. d
6. a
7. d
8. b
9. b
10. a
11. d
12. b
13. d
14. a
15. c
16. c
17. b
18. a
19. b
20. d
21. a
22. c
23. c
24. d
25. d
26. e
27. d
28. e
29. d
30. c
31. a
32. f
33. c
34. b
35. c
36. b
37. c
38. d
39. d
40. a
41. b
42. c
43. e
44. a





---

# Airplane Upset Recovery *Briefing*

**3-B**

Airplane Upset Recovery Briefing - Industry solution for large swept-wing turbofan airplanes typically seating more than 100 passengers.

(This page intentionally left blank)



APPENDIX 3-B

Airplane Upset Recovery Briefing



Figure 3-B.1

Accidents resulting from a loss of airplane control have been, and continue to be, a major contributor to fatalities in the worldwide commercial aviation industry. National Transportation Safety Board (NTSB) data show that between 1994 and 2003, there were at least 32 worldwide airline accidents attributed to airplane upset. There were more than 2100 fatalities as a result of these upsets and subsequent accidents.



Figure 3-B.2

Upsets have been attributed to environment, equipment, and pilot factors. The data also suggest that pilots need to be better prepared to cope with airplane upsets. Research by operators has indicated that most airline pilots rarely experience airplane upsets, and many have never been trained in maximum performance maneuvers.

# Causes of Airplane Upset

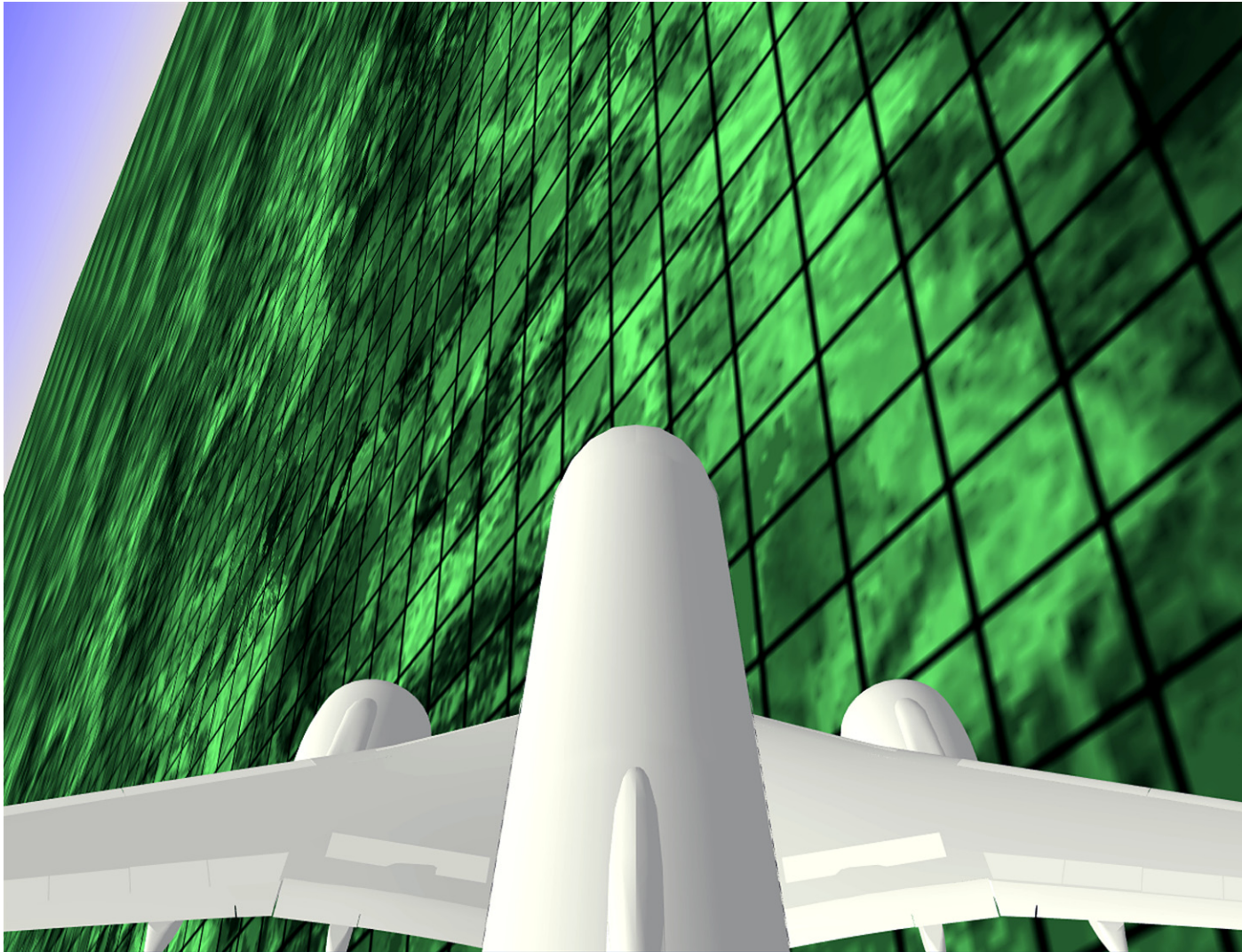

Figure 3-B.3

Airplane upsets that are caused by environmental factors are difficult to predict; therefore, training programs stress avoidance of such phenomena. Complete avoidance is not possible, as the statistics suggest; therefore, the logical conclusion is that pilots should be trained to safely recover an airplane that has been upset.

# Airplane Upset Recovery



Figure 3-B.4

The goal of an Upset Recovery Training Program is twofold:

- To increase the pilot's ability to recognize and avoid upset situations.
- To improve the pilot's ability to recover control, if avoidance is not successful.



# Upset Recovery Training Objectives

- **To increase the pilot's ability to recognize and avoid upset situations.**
- **To improve the pilot's ability to recover control, if avoidance is not successful.**

This briefing, as part of the overall Upset Recovery Training Program, is presented in three parts:

- The causes of airplane upsets.
- A brief review of swept-wing airplane fundamentals.
- Airplane upset recovery techniques.

# **Upset Recovery Training Will Review**

- **The causes of airplane upsets**
- **Swept-wing airplane fundamentals**
- **Airplane upset recovery techniques**

For discussion purposes, the following *unintentional* conditions generally describe an airplane upset:

- Pitch attitude greater than 25 deg nose up.
- Pitch attitude greater than 10 deg nose down.
- Bank angle greater than 45 deg.
- Within the above parameters, but flying at airspeeds inappropriate for the conditions.

A pilot must not wait until the airplane is in a fully developed and defineable upset before taking corrective action to return to stabilized flight path parameters.

The amount and rate of control input to counter a developing upset must be proportional to the amount and rate of pitch, roll, and/or yaw experienced.

# What is “Airplane Upset?”

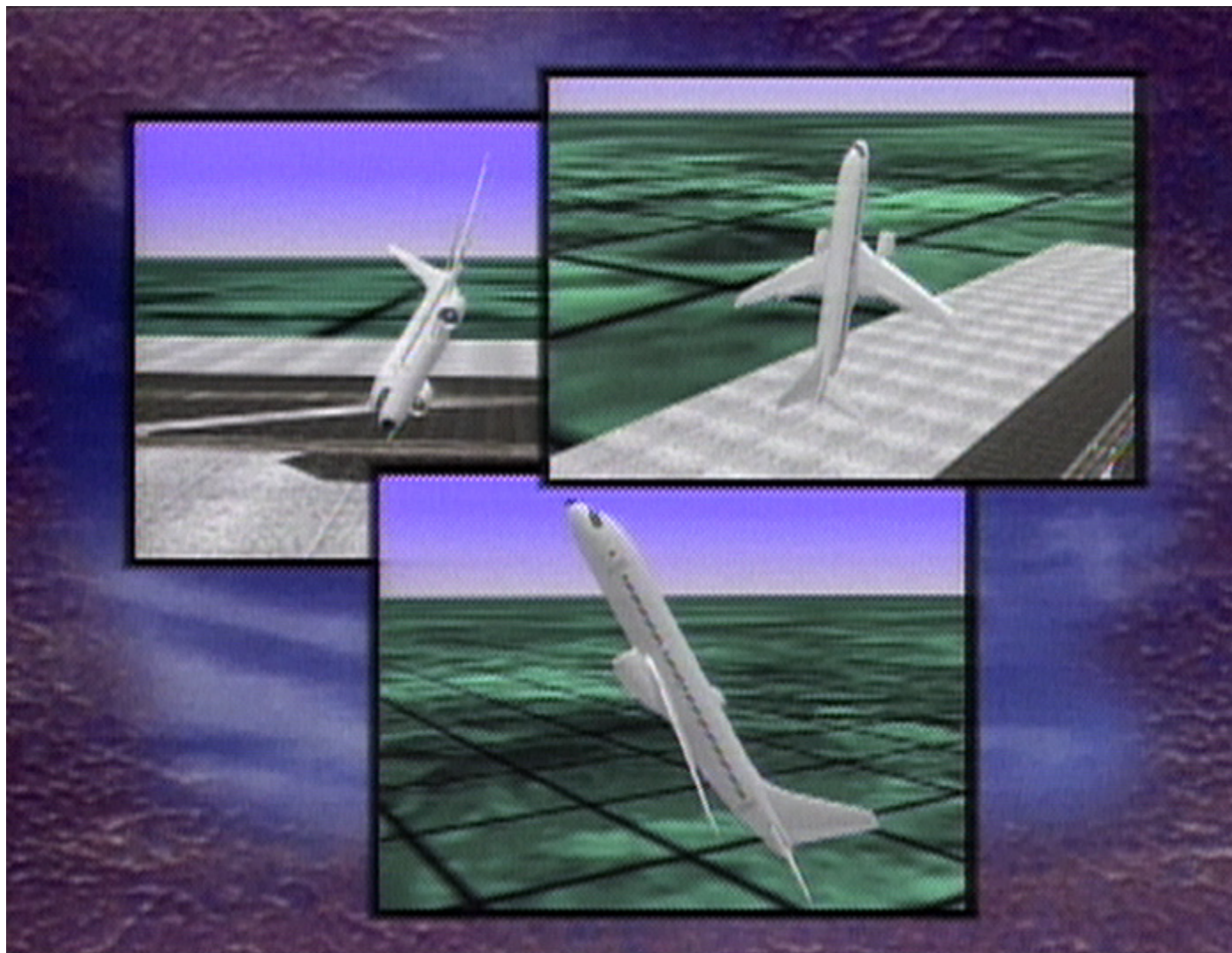

Figure 3-B.7

## Causes of Airplane Upset Incidents Are Varied

The causes of airplane upset incidents are varied; however, they can be broken down into four broad categories. They can be

- Environmentally induced.
- Systems-anomalies induced.
- Pilot induced.
- A combination of causes.

# Causes of Airplane Upset Incidents Are

- **Environmentally induced**
- **Systems-anomalies induced**
- **Pilot induced**
- **A combination of all three**

## Environmentally Induced Airplane Upsets Include

- Turbulence.
- Clear air turbulence.
- Mountain wave.
- Windshear.
- Thunderstorms.
- Microbursts.
- Wake turbulence.
- Airplane icing.



# **Environmental Causes of Airplane Upset Include**

- **Turbulence**
- **Clear air turbulence**
- **Mountain wave**
- **Windshear**
- **Thunderstorms**
- **Microbursts**
- **Wake turbulence**
- **Airplane icing**

## Turbulence

Turbulence is characterized by a large variation in an air current over a short distance. It is mainly caused by

- Jet streams.
- Convective currents.
- Obstructions to wind flow.
- Windshear.

Knowledge of the various types of turbulence assists in avoiding it and, therefore, the potential for an airplane upset.

# **Turbulence Is Primarily Caused by**

- **Jet streams**
- **Convective currents**
- **Obstructions to wind flow**
- **Windshear**

## Clear Air Turbulence (CAT)

Clear air turbulence (CAT) is defined as “high-level turbulence,” as it is normally above 15,000 MSL. It is not associated with cumuliform cloudiness, including thunderstorms. CAT is almost always present near jet streams. Jet streams are dynamic, and turbulence associated with them is difficult to predict. The area of turbulence can be 100 to 300 mi long—50 to 100 mi wide—and 2000 to 5000 ft thick.

# **Clear Air Turbulence (CAT) Is Characterized by Marked Changes in**

- **Pressure**
- **Temperature**
- **Wind direction**
- **Wind velocity**

## Mountain Wave Turbulence

Mountains are the greatest obstructions to wind flow. Therefore, this type of turbulence is classified as “mechanical.” Rotor or lenticular clouds over mountains are a sure sign of Mountain Wave Turbulence, but unfortunately the air may be too dry for the presence of the telltale clouds. Severe turbulence can be expected in mountainous areas, if the perpendicular wind component exceeds 50 kn.

# Mountain Wave Turbulence



Figure 3-B.12

## Windshear

Wind variations at low altitude are recognized as a serious hazard to airplanes during takeoff and approach. These variations can be caused by many differing meteorological conditions:

- Topographical.
- Temperature inversions.
- Sea breezes.
- Frontal systems.
- Strong surface winds.
- Thunderstorms.
- Microbursts.

The latter two, thunderstorms and microbursts, are the two most violent forms of wind change, and they will be discussed in more detail.



# Windshear

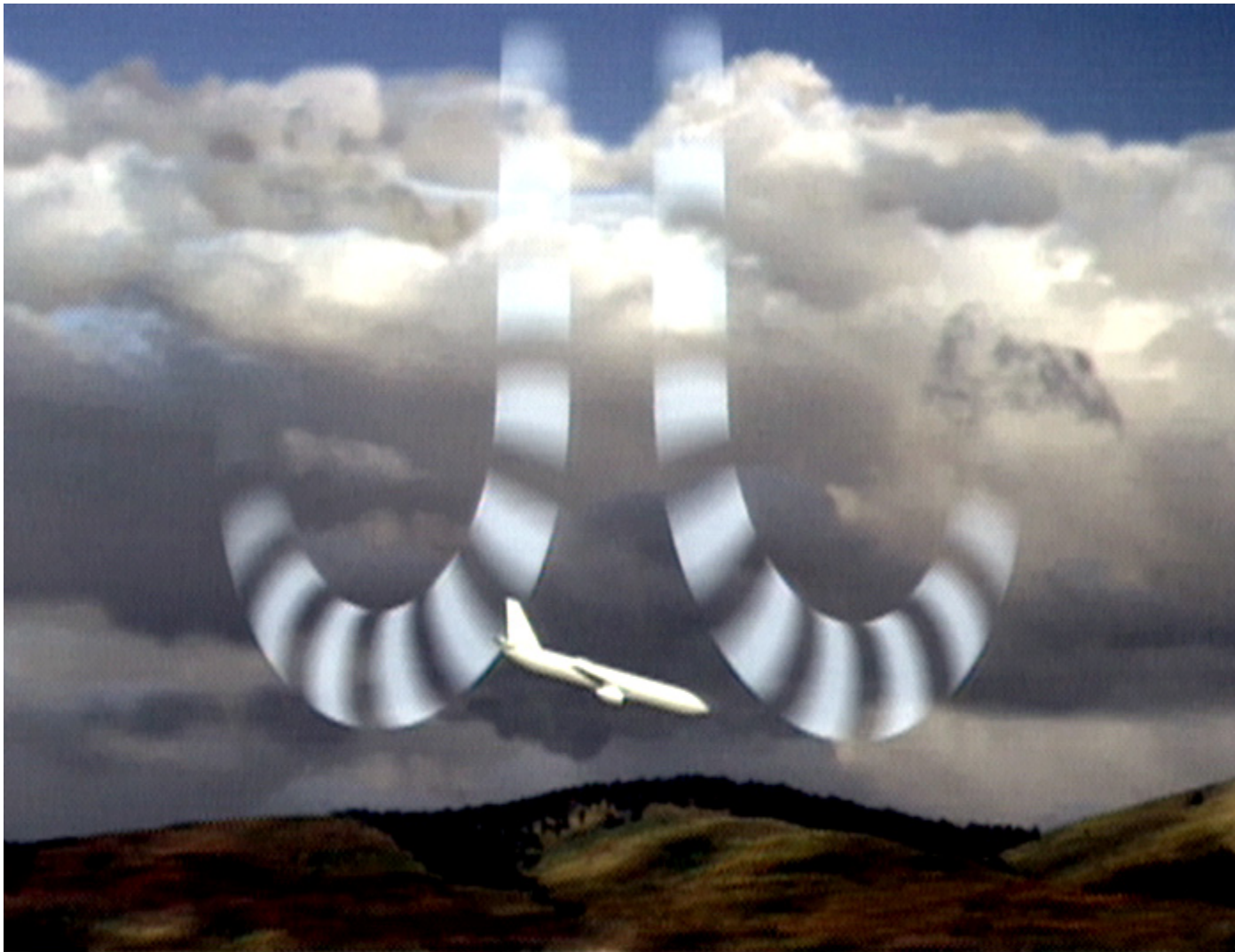

Figure 3-B.13

## Thunderstorms

There are two basic types of thunderstorms: airmass and frontal.

Airmass thunderstorms are randomly distributed in unstable air. Heated air rises to form cumulus clouds. The clouds develop in three stages: cumulus stage, mature stage, dissipating stage. The gust front produced by the downflow and outrush of rain-cooled air can produce very turbulent air conditions.

Frontal thunderstorms are associated with weather system line fronts, converging wind, and troughs aloft. Frontal thunderstorms form in squall lines; last several hours; generate heavy rain, and possibly hail; and produce strong gusty winds, and possibly tornadoes. The downdraft of a typical frontal thunderstorm is large, about 1 to 5 miles in diameter. Resultant outflows may produce large changes in windspeed.

# Thunderstorms



Figure 3-B.14

## Microbursts

Microbursts can occur anywhere convective weather conditions occur. Five percent of all thunderstorms produce microbursts. Downdrafts are typically only a few hundred to 3000 ft across. The outflows are not always symmetrical. A significant airspeed increase may not occur upon entering outflows, or it may be much less than the subsequent airspeed loss experienced when exiting. ***It is vital to recognize that some microbursts cannot be successfully escaped with any known techniques.***

# Microbursts

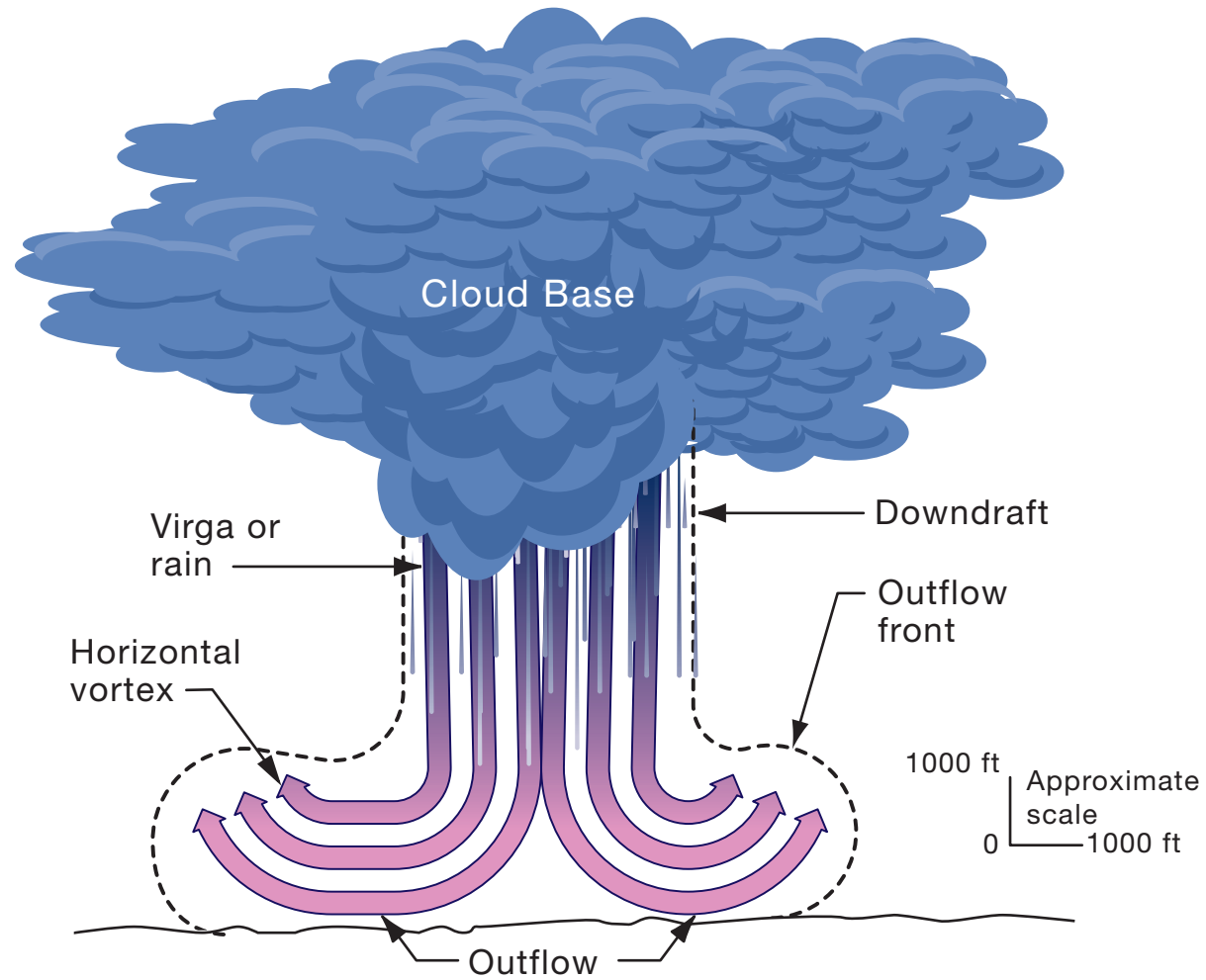

Figure 3-B.15

## Wake Turbulence

Wake turbulence is the leading cause of airplane upsets that are environmentally induced. A pair of counter-rotating vortices is shed from an airplane wing, thus causing turbulence in the airplane's wake. The strength of the turbulence is a function of airplane weight, wingspan, and speed. Vortices descend at an initial rate of 300 to 500 ft/min for about 30 sec. The descent rate decreases and eventually approaches zero at 500 to 900 ft below the flight path. Avoidance can be accomplished by flying above the offender's flight path. Maintaining a vertical separation of at least 1000 ft below the flight path is also considered safe. Pilots have likened a wake-turbulence encounter to be like "hitting a wall." Counter-control is usually effective. With little to no control input from the pilot, the airplane would be expelled from the wake and an airplane upset could result.

# Wake Turbulence

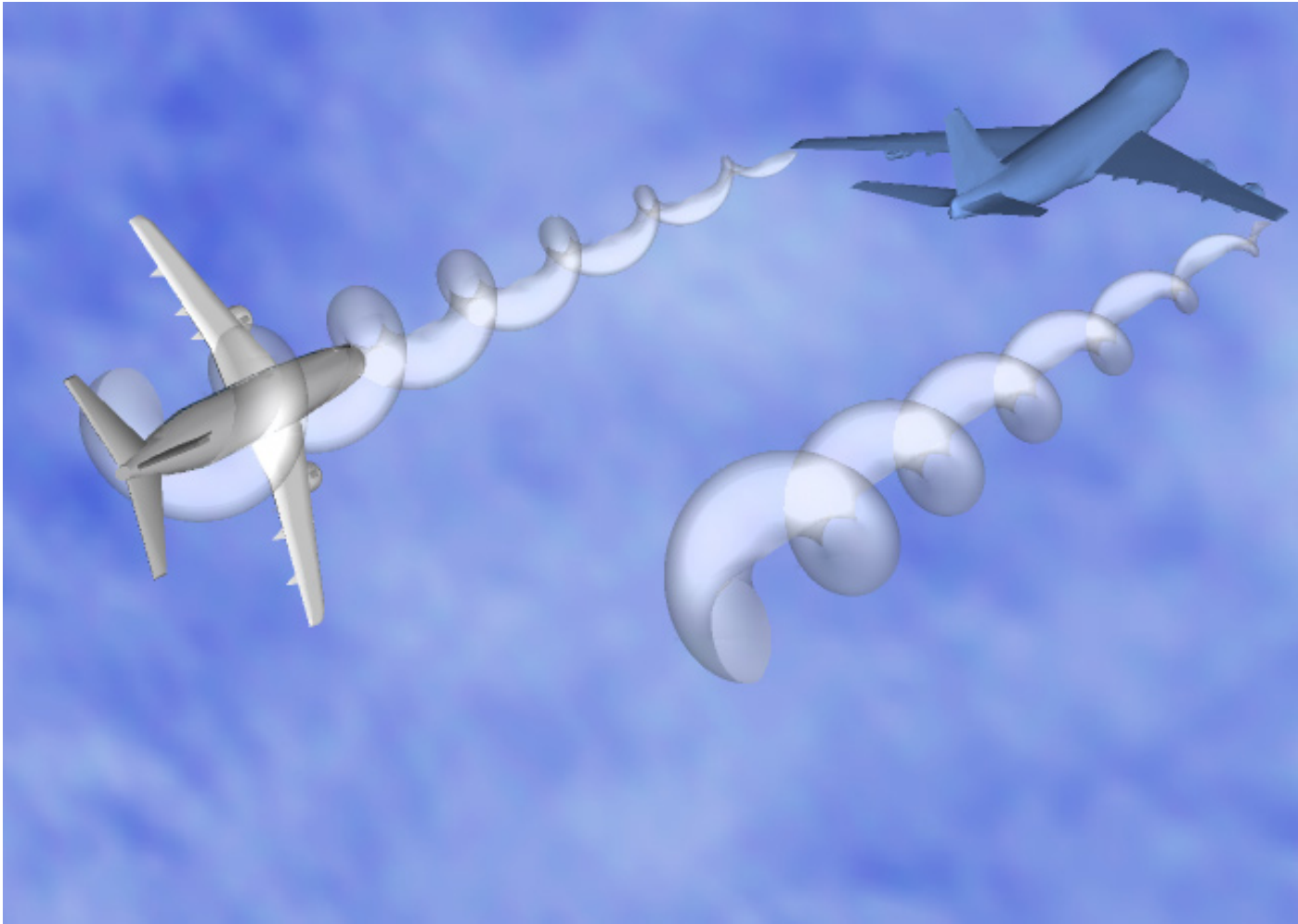

Figure 3-B.16

## Airplane Icing

Large degradation of airplane performance can result from the surface roughness of an extremely small amount of ice contamination. The handling characteristics and maximum lift capability can be adversely affected. Unanticipated changes in stability and control are very real possibilities. Therefore, the axiom of “keep it clean” for critical airplane surfaces continues to be a universal requirement.

This concludes our discussion of environmental elements that may lead to an airplane upset. The next subject for discussion involves airplane upsets that are induced by systems anomalies.



# Airplane Icing



Figure 3-B.17

## Systems-Anomalies Induced Airplane Upsets

The discussion will include

- Flight instruments.
- Autoflight systems.
- Flight controls and other anomalies.

# **System-Anomalies Induced Airplane Upsets Primarily Involve**

- **Flight instruments**
- **Autoflight systems**
- **Flight controls and other anomalies**

## Systems-Anomalies Induced Airplane Upsets

In spite of improved airplane design, intensified training programs, and improved reliability, we still experience systems failures. Some of these failures can lead to an airplane upset. Most failures are survivable if the flight crew makes correct responses.

# System-Anomalies Induced Airplane Upsets



Figure 3-B.19

## Flight Instruments

Instrument failures are infrequent, but they do occur. All airplane operations manuals provide flight instrument system information, such that when instrument failures do occur, the pilot can analyze the impact and select the correct procedural alternatives. Airplane certification requires that pilots have the minimum information needed to safely control the airplane in the event of instrument failure. Several accidents point out that pilots are not always prepared to correctly analyze the alternatives in case of failure. The result is an airplane upset.

# Flight Instruments



Figure 3-B.20

## Autoflight Systems

Autoflight systems include autopilot, autothrottles, and all related systems that perform flight management and guidance. The systems integrate information from a variety of other aircraft systems. The pilot community has tended to develop a great deal of confidence in the systems, which has led to complacency in some cases. Although quite reliable, failures do occur. These failures have led to airplane upsets and accidents.



# Autoflight Systems

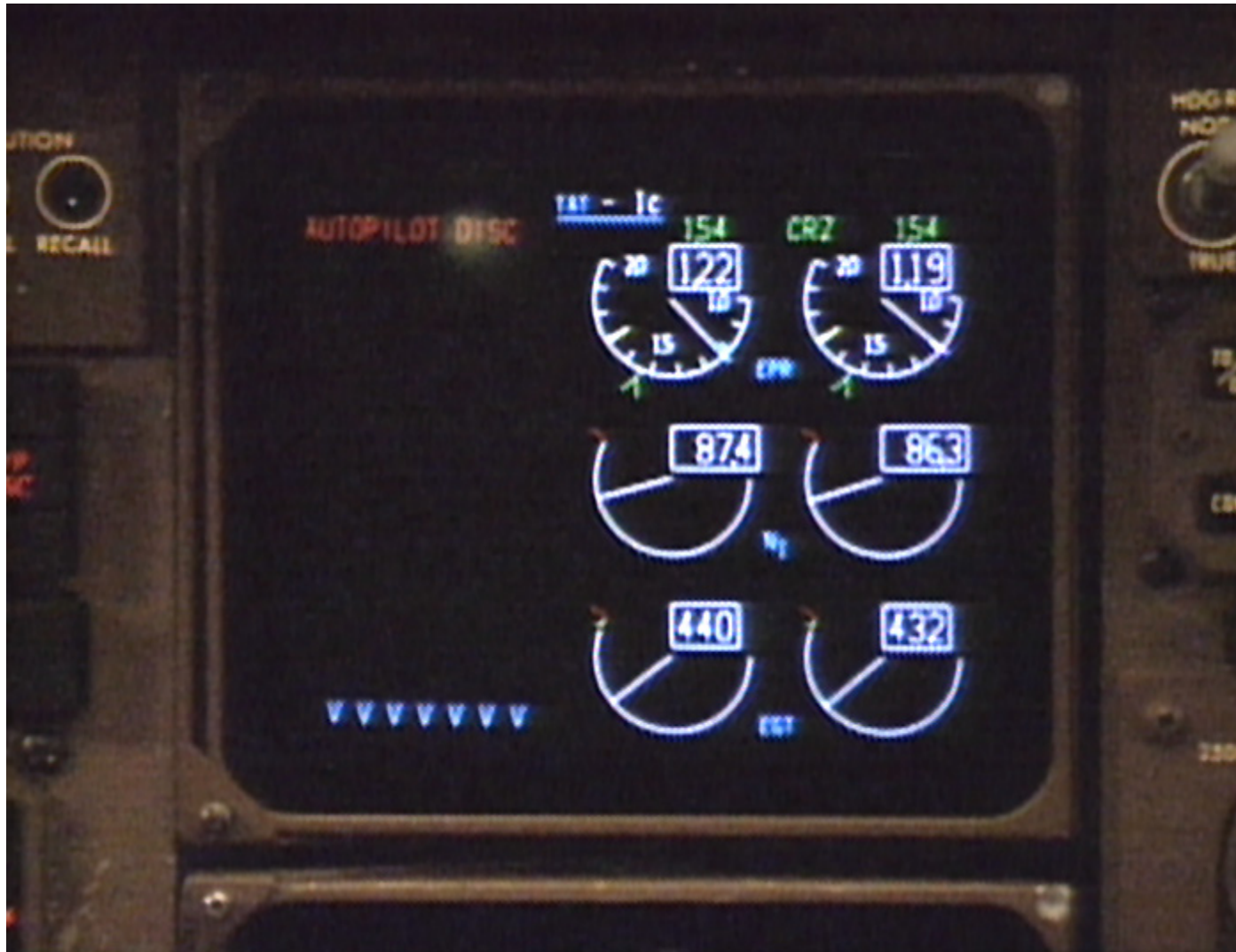

Figure 3-B.21

## Flight Control and Other Anomalies

Flap asymmetry, spoiler problems, and other flight control anomalies are addressed in airplane operations manuals. Airplane certification requirements ensure that pilots have sufficient information and are trained to handle these critical failures. However, it is the unexpected that can cause problems, particularly during critical phases of flight.

# Flight Control and Other Anomalies



Figure 3-B.22

## Pilot-Induced Airplane Upsets

We have known for many years that sensory inputs can be misleading to pilots, especially when pilots cannot see the horizon. To solve this problem, airplanes are equipped with flight instruments to provide the necessary information for controlling the airplane. Subjects for discussion in this area include

- Instrument cross-check.
- Inattention and distraction from primary cockpit duties.
- Vertigo or spatial disorientation.
- Improper use of airplane automation.

# **Pilot-Induced Causes of Airplane Upset Include**

- **Instrument misinterpretation or slow cross-check**
- **Inattention and distraction from primary cockpit duties**
- **Vertigo or spatial disorientation**

## Instrument Cross-Check

Instrument misinterpretation or a slow cross-check can lead to an airplane upset. Many minor upsets can be traced to an improper instrument cross-check. However, a good cross-check and proper interpretation is only one part of the equation. It is necessary for the pilot to make the correct adjustments to pitch, bank, and power in order to control the airplane.

# Instrument Cross-Check

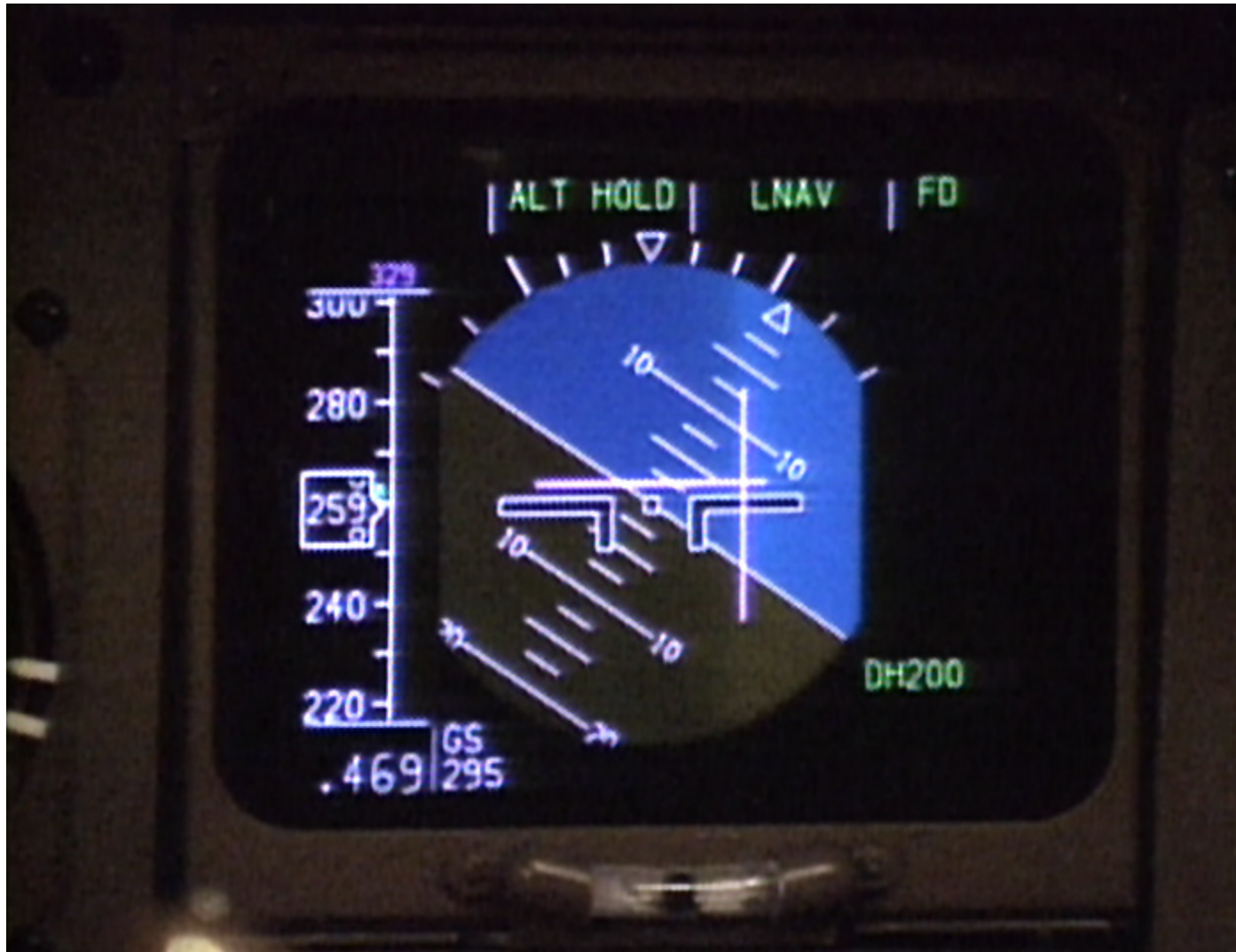

Figure 3-B.24

## Inattention or Distraction From Primary Cockpit Duties

A review of airplane upsets reveals that inattention or neglecting to monitor the airplane's performance can lead to extreme deviations from the normal flight envelope. Neglecting to monitor all the instruments or fixating on a certain instrument can lead to performance deviations. Distractions can be very subtle, such as warning or caution lights illuminating during critical phases of flight. Many airplane upsets occur while the pilot is engaged in some task that takes attention away from the flight instruments. "Control the airplane first" should always be the guiding principle.



# Distraction



Figure 3-B.25

## Vertigo or Spatial Disorientation

Spatial disorientation has been a significant factor in many airplane-upset accidents. The definition of spatial disorientation is the inability to correctly orient oneself with respect to the Earth's surface. We are all susceptible to sensory illusions. Pilots who perceive a conflict between bodily senses and the flight instruments and are unable to resolve the conflict are spatially disorientated. Allowed to continue, spatial disorientation will lead to airplane upset. Attention to flight instruments and a good cross-check are the keys to remaining spatially orientated.

# Vertigo or Spatial Disorientation



Figure 3-B.26

## Improper Use of Airplane Automation

The advancement of technology in today's modern airplanes has brought us flight directors, autopilots, autothrottles, and flight management systems. When used properly, this technology contributes to flight safety and reduces crew workload. Complacent and improper use of these systems is a concern. The systems can and do fail, leading to airplane upsets and accidents.

# Improper Use of Airplane Automation



Figure 3-B.27

## Causes of Airplane Upsets—Summary

Three basic causes

1. Environmentally induced:

- Turbulence, CAT, mountain wave, windshear, thunderstorms, microbursts, wake turbulence, and airplane icing.

2. Systems-anomalies induced:

- Flight instruments, autoflight systems, and flight control anomalies.

3. Pilot induced:

- Instrument cross-check, inattention and distraction from primary cockpit duties, vertigo or spatial disorientation, and improper use of airplane automation.

The next part of this briefing will focus on basic airplane fundamentals as they apply to us as pilots of swept-wing transport airplanes.

# Causes of Airplane Upsets—Summary

## 1. Environmental:

**Turbulence, CAT, mountain wave, windshear, thunderstorms, microbursts, wake turbulence, and airplane icing**

## 2. Systems anomalies:

**Flight instruments, autoflight systems, and flight control anomalies**

## 3. Pilot induced:

**Instrument cross-check, inattention and distraction from primary cockpit duties, vertigo or spatial disorientation, and improper use of airplane automation**

## Swept-Wing Airplane Fundamentals for Pilots

The areas of interest include

- Flight dynamics.
- Energy states.
- Load factors.
- Aerodynamic flight envelope.
- Aerodynamics.



# **Swept-Wing Airplane Fundamentals Will Overview**

- **Flight dynamics**
- **Energy states**
- **Load factors**
- **Aerodynamic flight envelope**
- **Aerodynamics**

## Flight Dynamics

In understanding the flight dynamics of large, swept-wing transport airplanes, it is important to first understand what causes the forces and moments acting on the airplane and then move to what kinds of motion these forces cause. With this background, we can gain an understanding of how a pilot can control these forces and moments in order to direct the flight path.

Newton's first law states that an object at rest will tend to stay at rest, and an object in motion will tend to stay in motion in a straight line, unless acted on by an external force. If an airplane in motion is to deviate from a straight line, there must be a force, or a combination of forces, imposed to achieve the desired trajectory. The generation of the forces is the subject of aerodynamics (to be discussed later). The generation of forces requires energy, which for discussion purposes can be called "energy state."

# Flight Dynamics

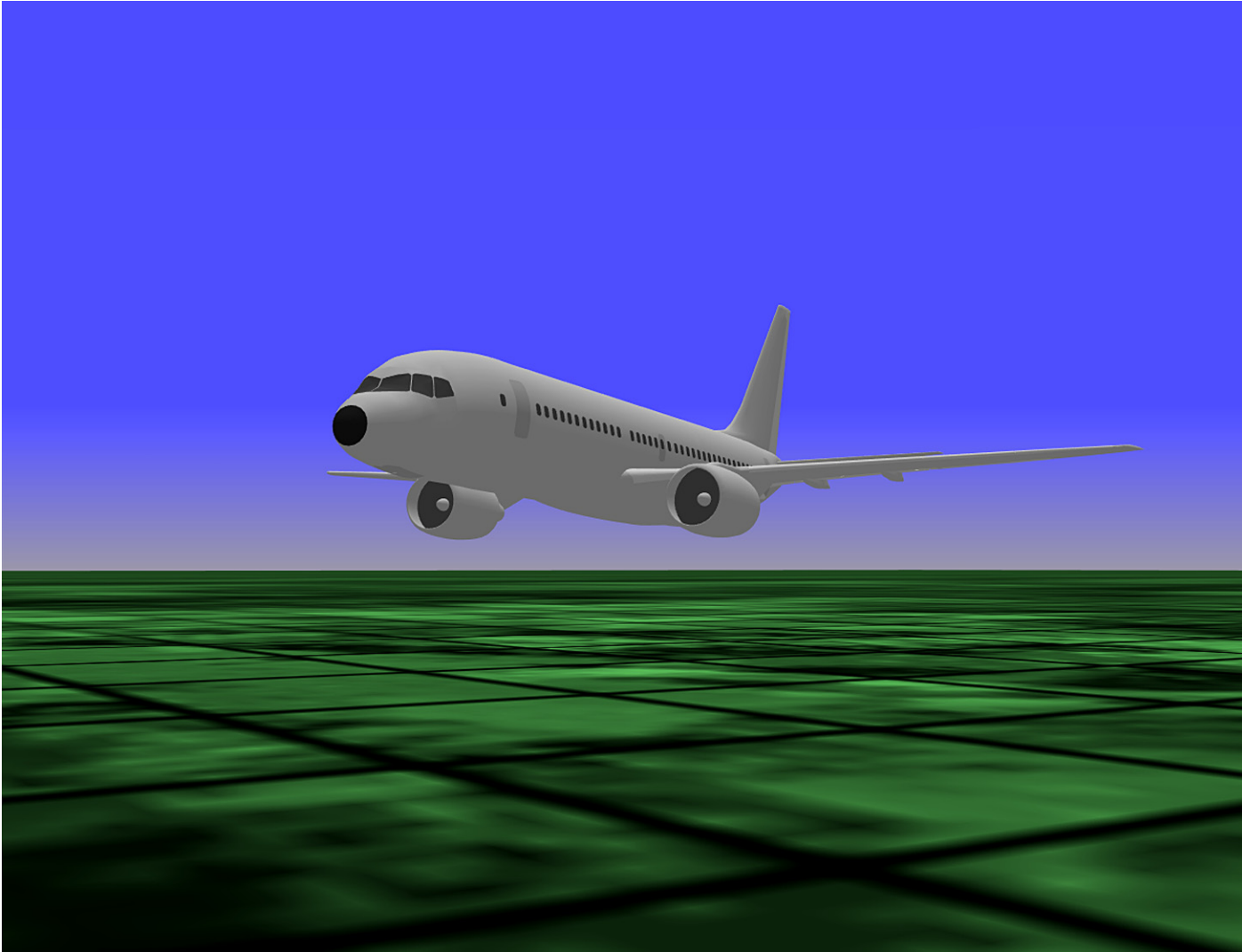

Figure 3-B.30

## Energy States

The term “energy state” describes how much of each kind of energy the airplane has available at any given time. Pilots who understand the airplane energy state will be in a position to know instantly what options they may have to maneuver their airplane.

The three sources of energy available to the pilot are

1. Kinetic energy, which increases with increasing airspeed.
2. Potential energy, which is approximately proportional to altitude.
3. Chemical energy, from the fuel in the tanks.

# **The Three Sources of Energy Available to the Pilot Are**

- 1. Kinetic energy, which increases with increasing speed**
- 2. Potential energy, which is approximately proportional to altitude**

## Energy States (continued)

During maneuvering, these three types of energy can be traded, or exchanged, usually at the cost of additional drag. The relationships are shown here:

- Airspeed can be traded for altitude, and altitude can be traded for airspeed.
- Stored energy can be traded for either altitude or airspeed.

Modern high-performance, jet transport airplanes have low drag characteristics in cruise configuration; therefore, the pilot needs to exercise considerable judgement in making very large energy trades. A clean airplane operating near its limits can easily go from the low-speed boundary to and through the high-speed boundary very quickly. The process of controlling forces to change accelerations and produce a new energy state takes time. The longer time required by large airplanes requires that the pilot plan ahead—that much more—to achieve the final desired energy state. The objective is to manage energy so that kinetic energy stays between limits (stall and placards), the potential energy stays with limits (terrain to buffet altitude), and chemical energy stays above certain thresholds (not running out of fuel).

# Energy Relationships

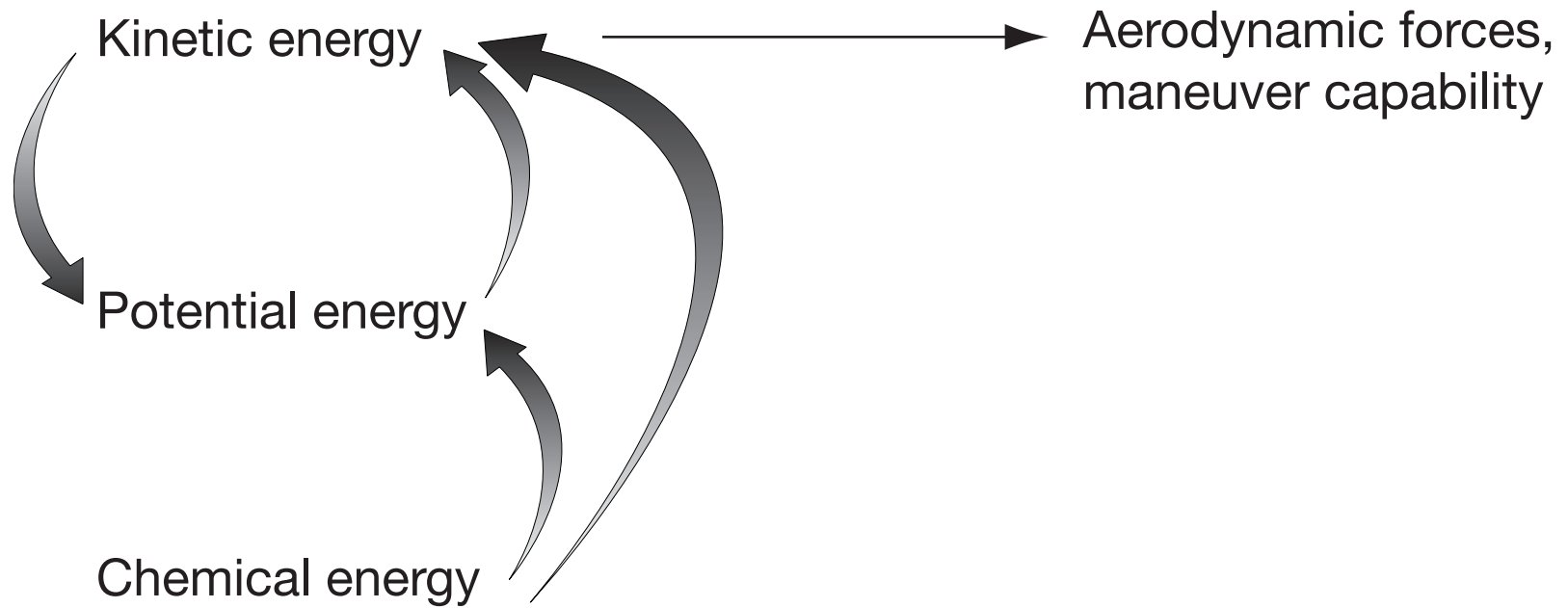

Figure 3-B.32

## Load Factors

Newton's second law, *force = mass x acceleration*, is the basis for discussing airplane load factors. Since the airplane has mass, if it is being accelerated there must be force acting on it. Conversely, if there is a force acting on an airplane, it will accelerate.

Acceleration refers to a change in either magnitude or direction of the velocity. It is convenient to refer to acceleration in terms of gravity, or simply, g's. The load factor expressed in g's is typically discussed in terms of components relative to the principal axes of the airplane:

- Longitudinal (fore and aft, typically thought of as speed change).
- Lateral (sideways).
- Vertical (or normal).



# Load Factors—Four Forces of Flight

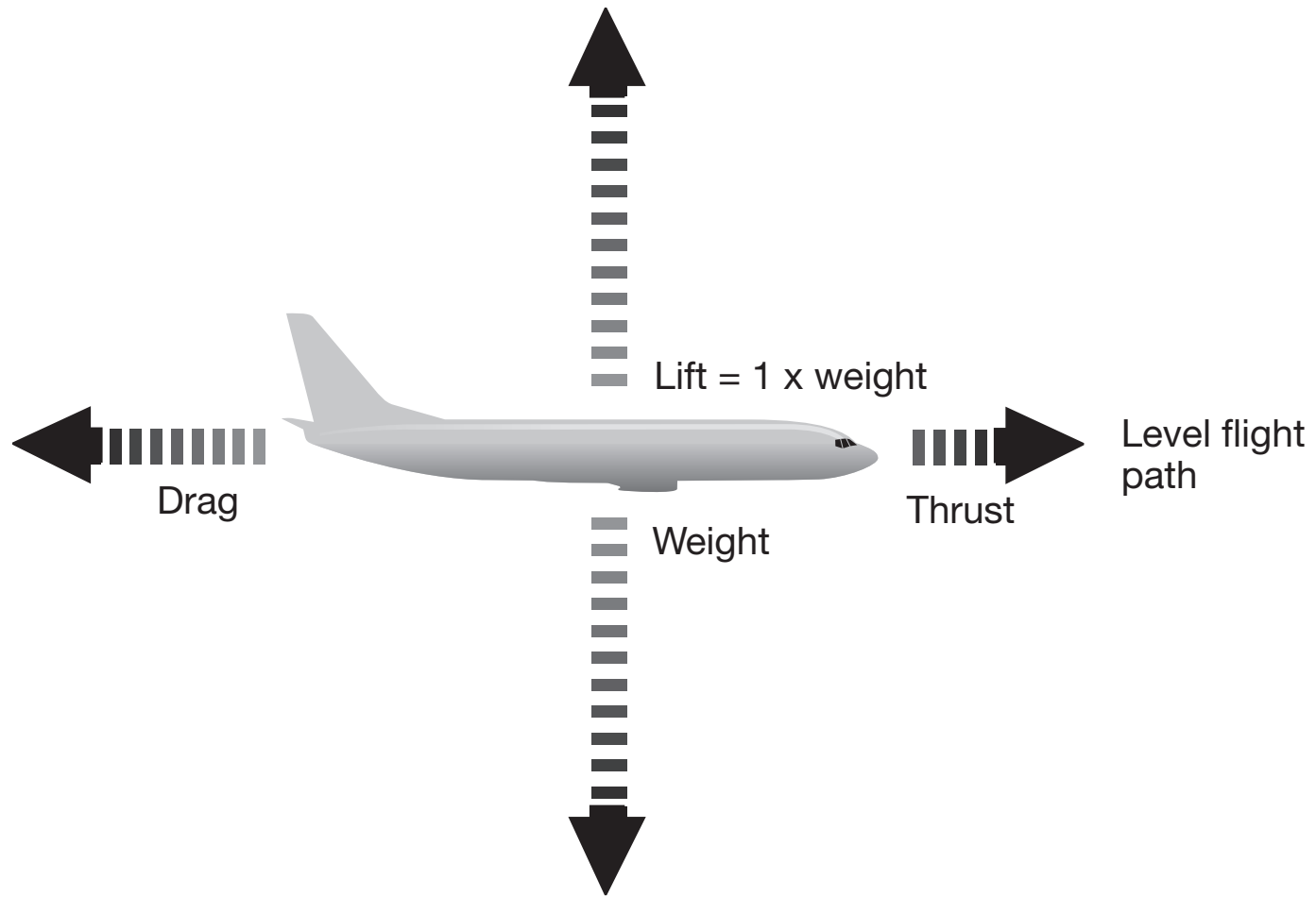

Figure 3-B.33

## Load Factors (continued)

In level flight, the vertical load factor is 1 times the acceleration due to gravity, or 1.0. In a pull-up, the load factor is above 1.0 and the flight path is curved. In a sustained vertical climb along a straight line, the thrust must be greater than the weight and drag. The wing and the load factor perpendicular to the airplane floor must be zero. Anything but zero will produce a curved flight path. Acceleration is a result of the sum of all forces acting on the airplane. One of these forces is always gravity, and gravity always produces an acceleration vector directed toward the center of the Earth. Aerodynamic forces are produced as a result of the orientation and magnitude of the velocity vector relative to the airplane, which are reduced into angles of attack and sideslip. It is the direction and speed of the airplane through the air that results in aerodynamic forces. More on these forces later.

# Load Factors—Airplane in Pull-Up

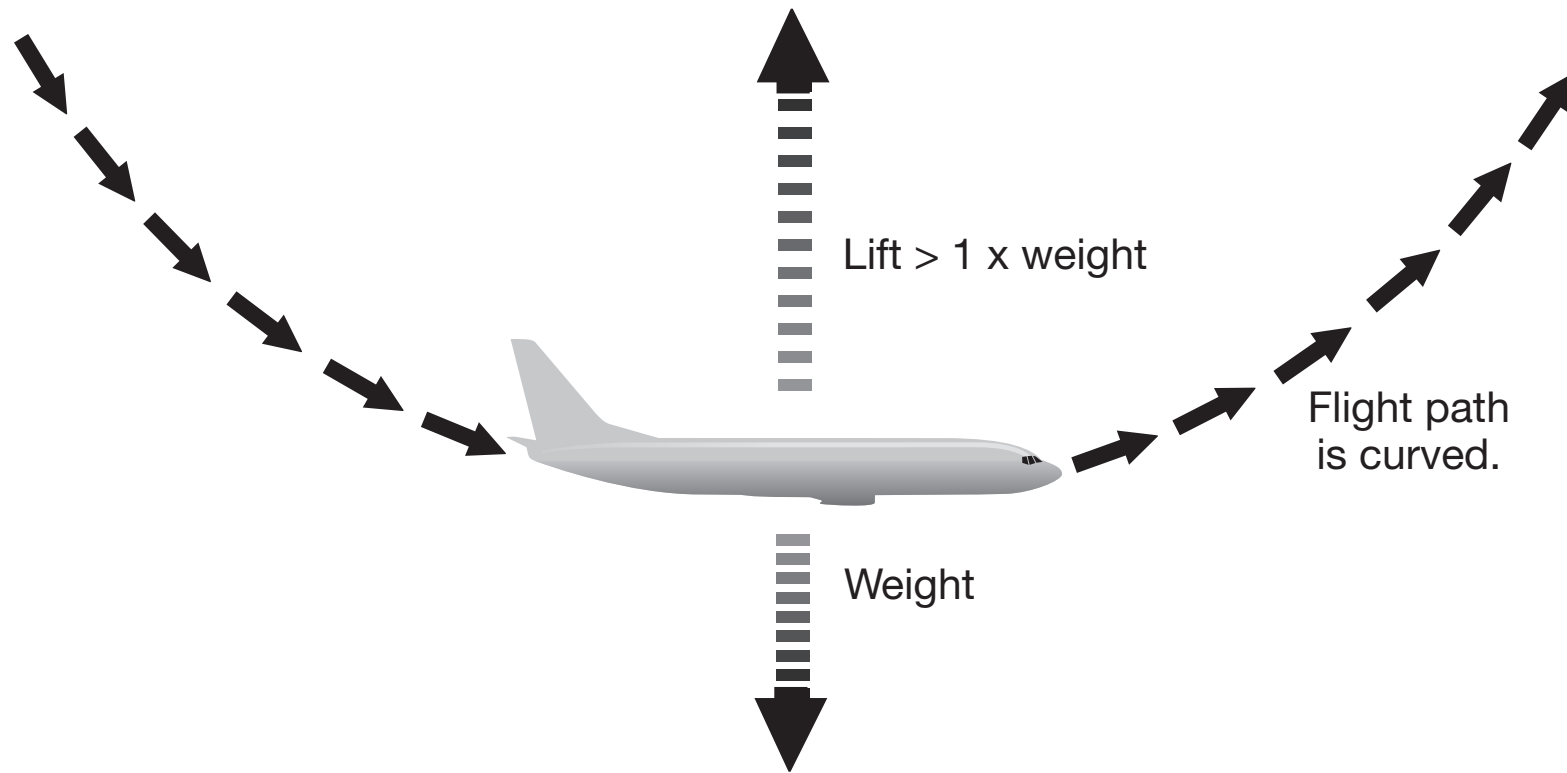

Figure 3-B.34

## Aerodynamic Flight Envelope

Current jet transport airplanes are certificated to withstand normal vertical load factors from -1.0 to 2.5 g in the cruise configuration. In addition to the strength of the structure, the handling qualities are demonstrated to be safe within these limits of load factors. The pilot should be able to maneuver safely to and from these load factors at these speeds, without needing exceptional strength or skills. Test pilots have evaluated the characteristics of airplanes in conditions that include inadvertent exceedances of these operational envelopes to demonstrate that the airplanes can be returned safely to the operational envelopes. This slide depicts a typical flight envelope, but it also shows the maximum demonstrated Mach and speed numbers. These are typically 0.05 to 0.07 Mach and 50 kn higher than the operational limits. Safe flight characteristics to return to the normal operational envelope must be demonstrated.

# Aerodynamic Flight Envelope

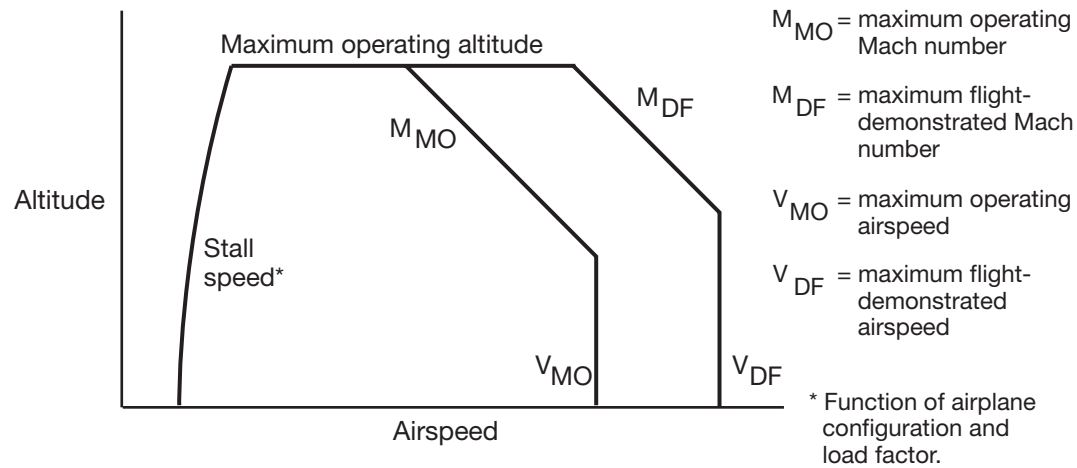
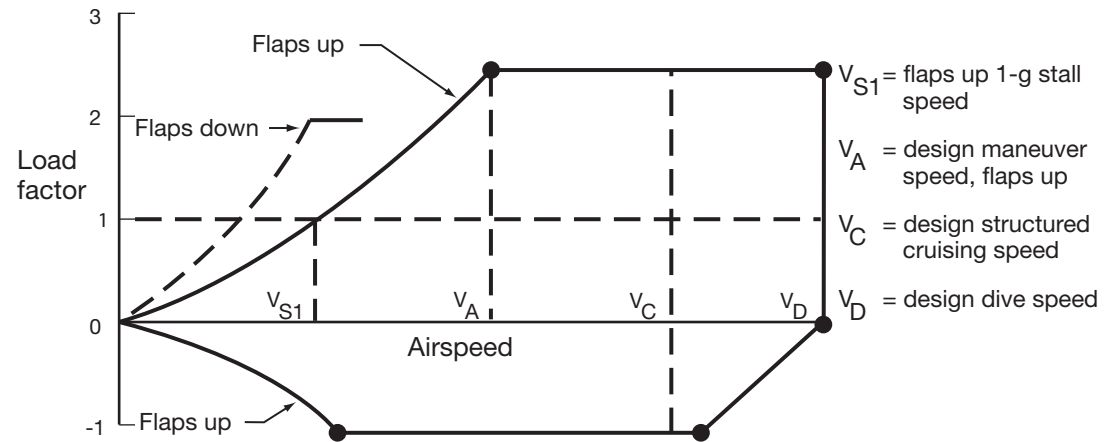

Figure 3-B.35

## Angle of Attack and Stall

Wing and tail surfaces all produce lift forces in the same way. The lift force generated by a surface is a function of the angle of attack, the dynamic pressure (proportional to the air density and the square of the true airspeed) of the air moving around it, and the size of the surface. It is important to understand the dependence of lift on angle of attack. As angle of attack is increased, lift increases proportionally up to the point where the air starts to separate from the wing. At this critical angle of attack, the airflow breaks down and the surface is stalled. This is true regardless of airplane speed or altitude. Angle of attack can sometimes be confusing.

The three angles usually referred to in the longitudinal axis are

- Angle of attack.
- Flight path angle.
- Pitch attitude.

These three angles and their relationships to each other are shown here. Depending on the context in which it is used, aerodynamicists use the term “angle of attack” in a number of different ways. Angle of attack is always the angle between the oncoming air or relative wind, and some reference line on the airplane or wing. Sometimes it is referenced to the chord line at a particular location on the wing, sometimes to an “average” chord line on the wing, other times it is referenced to a convenient reference line on the airplane, like the body reference x axis. Regardless of the reference, the concept is the same as are the consequences: exceed the critical angle of attack and the lifting surfaces and wind will separate, resulting in a loss of lift on those surfaces. Frequently the term “airplane angle of attack” is used to refer to the angle between the relative wind and the longitudinal axis of the airplane. In flight dynamics, this is frequently reduced to simply “angle of attack.” It is also the difference between the pitch angle and the flight path

# Angle of Attack

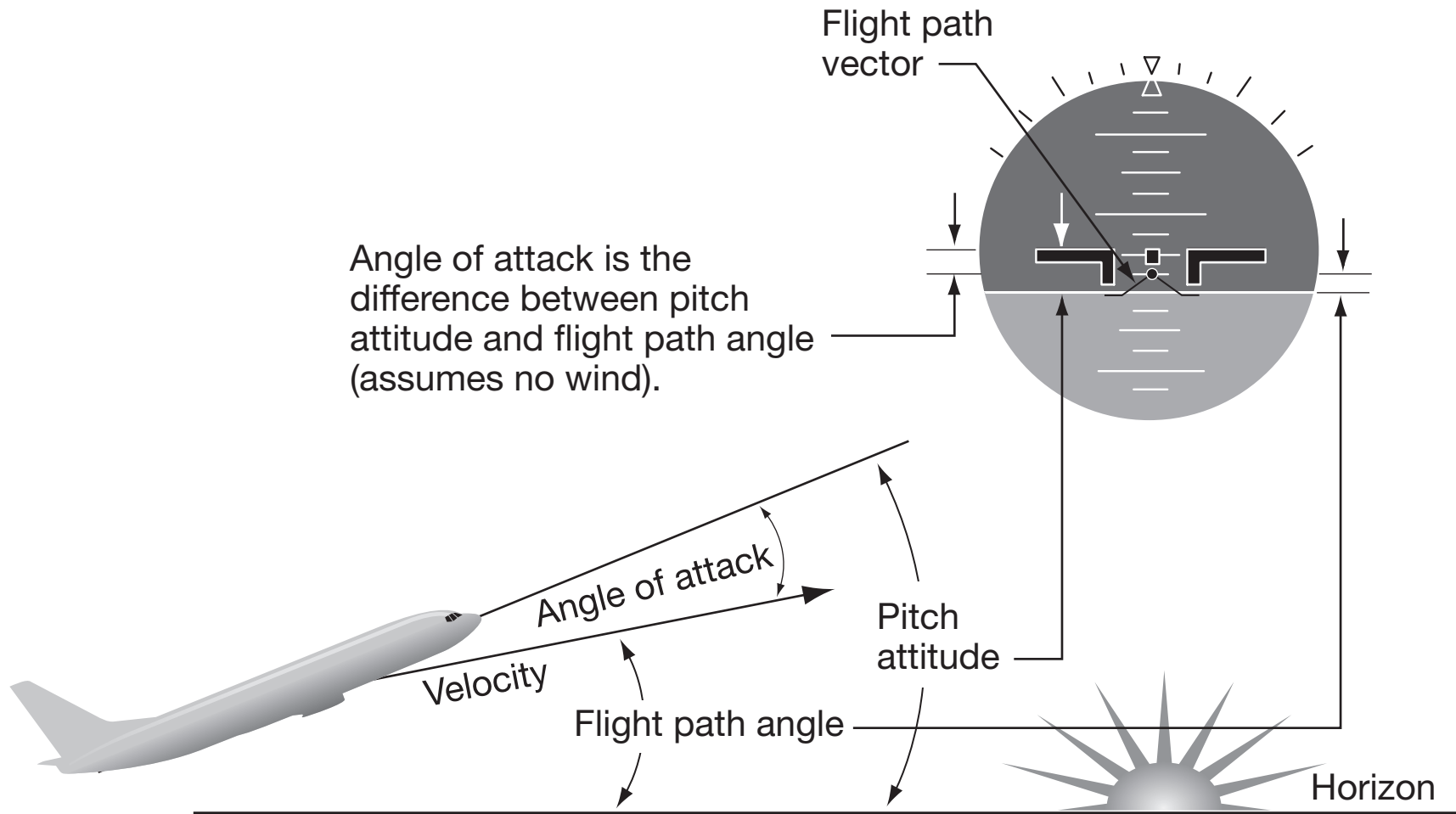

Figure 3-B.36

## Angle of Attack and Stall (continued)

The important point is that when the angle of attack is above the stall angle, the lifting capability of the surface is diminished. More importantly, an airplane can be stalled in any attitude and at any airspeed. The angle of attack determines whether the wing is stalled. A stall is characterized by any, or a combination, of the following:

- Buffeting.
- Lack of pitch authority.
- Lack of roll control.
- Inability to arrest the descent rate.

A stall must not be confused with an approach-to-stall warning that occurs before the stall. Stall speeds are published in the Approved Flight Manual (AFM). It should be remembered, however, that these speeds are based on precisely defined flight conditions. In conditions other than these, the stall speed can be considerably different. Many airplane upsets are quite dynamic and involve elevated load factors and large speed-rate changes. It should also be noted that the critical angle of attack is reduced at higher Mach numbers (higher altitude).



# Stalls

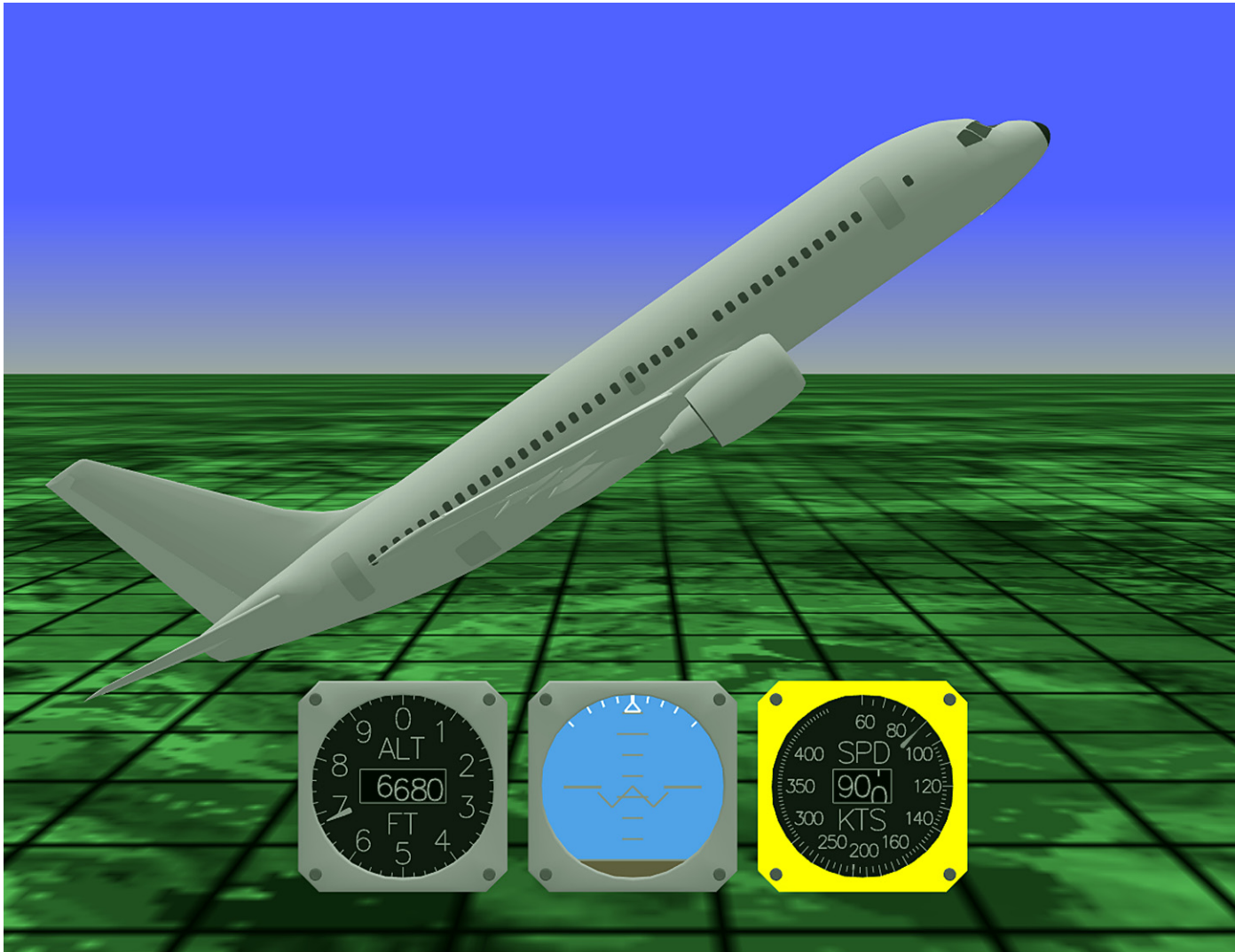
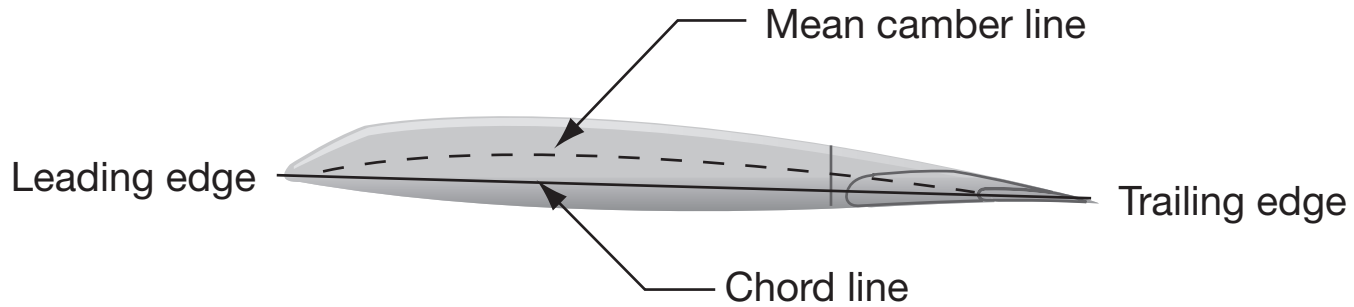

Figure 3-B.37

## Camber

Camber is illustrated here and refers to the amount of curvature evident in an airfoil shape. Airfoils with camber are more efficient at producing lift than those without. Airfoils with specific kinds of camber are more efficient in specific phases of flight. For example, aerobatic airplanes usually employ symmetrical airfoils. These work well for that purpose, but are not efficient in cruise flight. The fixed camber of a lifting surface is built into the lifting surface, depending on the airplane's main function. There are, of course, many ways to change a surface's camber in flight.

# Camber



## Cambered Airfoil



**Symmetrical Airfoil**

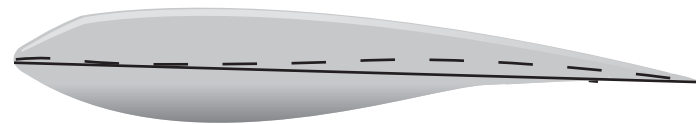

**Modern Aft-Cambered Airfoil**

## Control Surface Fundamentals

Trailing edge control surfaces provide a way of modulating the lift on a surface without physically changing that surface's angle of attack. The aerodynamic effect is that of increasing the lift at a constant angle of attack for trailing edge down deflection. As you can see, the price paid is a reduced angle of attack for stall at higher deflection angles. Large downward aileron deflections, at very high angles of attack, could induce air separation over that portion of the wing. Reducing the angle of attack before making large aileron deflections will help ensure the effectiveness of those surfaces.

# Trailing Edge Control Surfaces

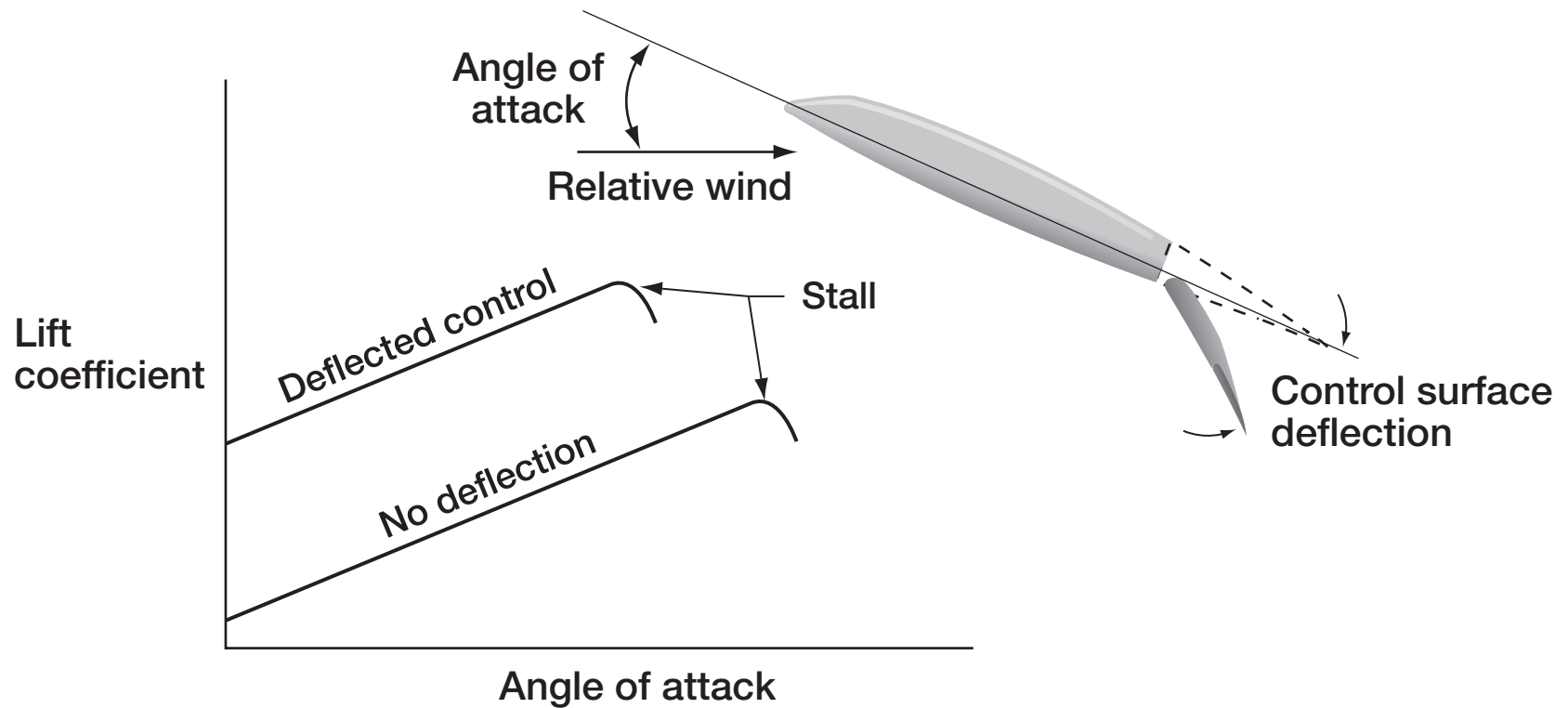

Figure 3-B.39

## Spoiler-Type Devices

Spoilers serve a dual purpose:

- Spoiling wing lift.
- Generating additional drag.

Spoilers separate airflow and stall the wing locally. Their effectiveness depends on how much lift the wing is generating. If the wing is producing large amounts of lift, as in the case of the flaps extended and at moderate angles of attack, the spoilers become effective control devices because there is more lift to spoil. Conversely, if the airflow is already separated, putting a spoiler up will not induce any more separation. As was the case with aileron control surfaces, the wing must be unstalled in order for the aerodynamic controls to be effective.

# Spoiler Devices

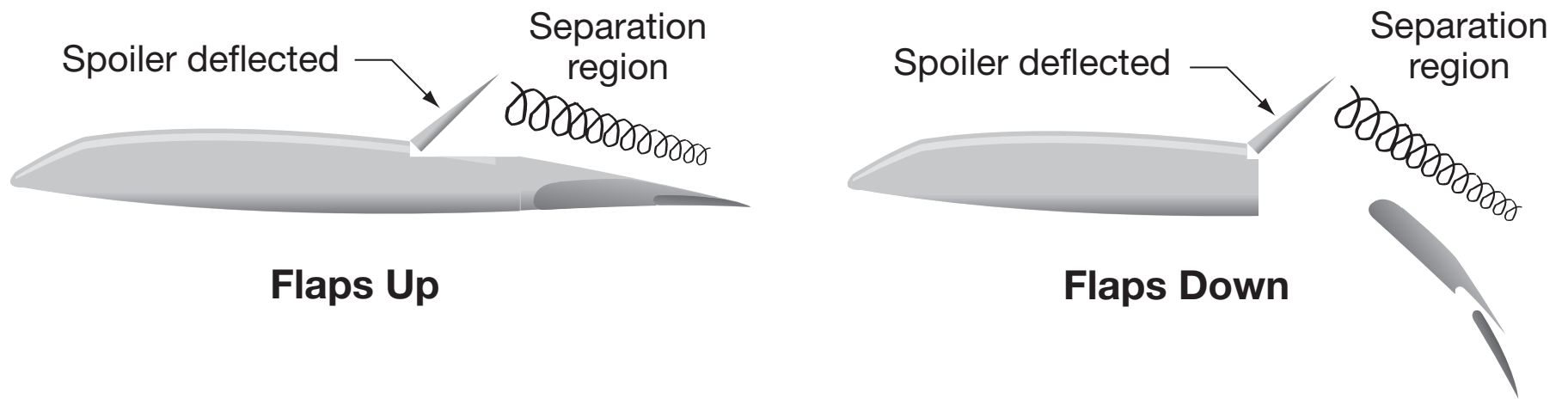

Figure 3-B.40

## Trim

“Trim” is defined as that condition in which the forces on the airplane are stabilized and the moments about the center of gravity all add up to zero.

“Pilot Trim” is that condition in which the pilot can release the controls and the airplane will continue to fly in the manner desired.

In the pitch axis, trim is achieved by varying the lift on the horizontal tail/elevator combination to balance the pitching moments about the center of gravity. Traditionally, there have been three ways of doing that:

1. Fixed stabilizer/trim: Maneuver limitations if trimmed near a deflection limit.
2. The all-flying tail: Requires powerful, fast-acting, irreversible flight control systems.
3. Trimmable stabilizer: From a trimmed position, full elevator authority is available.



# Trim

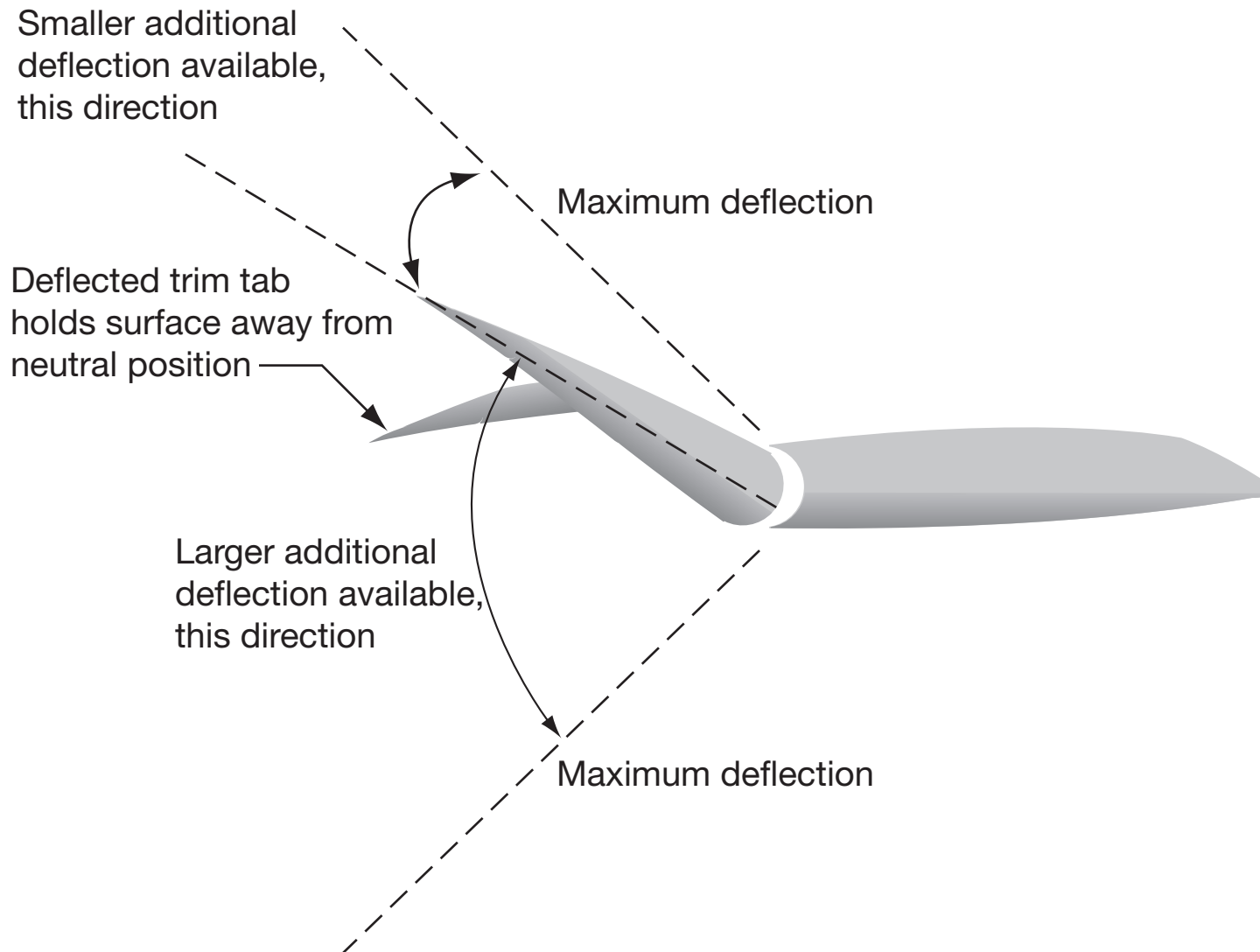

Figure 3-B.41

## Lateral and Directional Aerodynamic Considerations

The static lateral stability of an airplane involves consideration of rolling moments due to sideslip.

Aerodynamically, anti-symmetric flight, or flight in sideslip, can be quite complex. The forces and moments generated by the sideslip can affect motion in all three axes of the airplane. As will be seen, sideslip can generate strong aerodynamic rolling moments as well as yawing moments. In particular the magnitude of the coupled roll-due-to-sideslip is determined by several factors. Among them are

- Wing dihedral effects.
- Angle of sideslip.
- Pilot-commanded sideslip.

# **Lateral and Directional Aerodynamic Considerations**

**The magnitude of coupled roll-due-to-sideslip is determined by several factors, including**

- Wing dihedral effects**
- Angle of sideslip**
- Pilot-commanded sideslip**

## Wing Dihedral Effects

Dihedral is the positive angle formed between the lateral axis of an airplane and a line that passes through the center of the wing. A wing with dihedral will develop stable rolling moments with sideslip, and it contributes to the lateral stability of an airplane. The term “dihedral effect” is used when describing the effects of wing sweep and rudder on lateral stability and control. Wing sweep is beneficial for high-speed flight because it will delay compressibility effects. Wing sweep also contributes to the dihedral effect. A sideslip on a swept-wing airplane results in a larger rolling moment than on a straight-wing airplane. Rudder input produces sideslip and contributes to the dihedral effect. The effect is proportional to the angle of sideslip. At high angles of attack, aileron and spoiler roll controls become less effective. The rudder is still effective; therefore, it can produce large sideslip angles, which in turn produces roll

# Wing Dihedral Angle

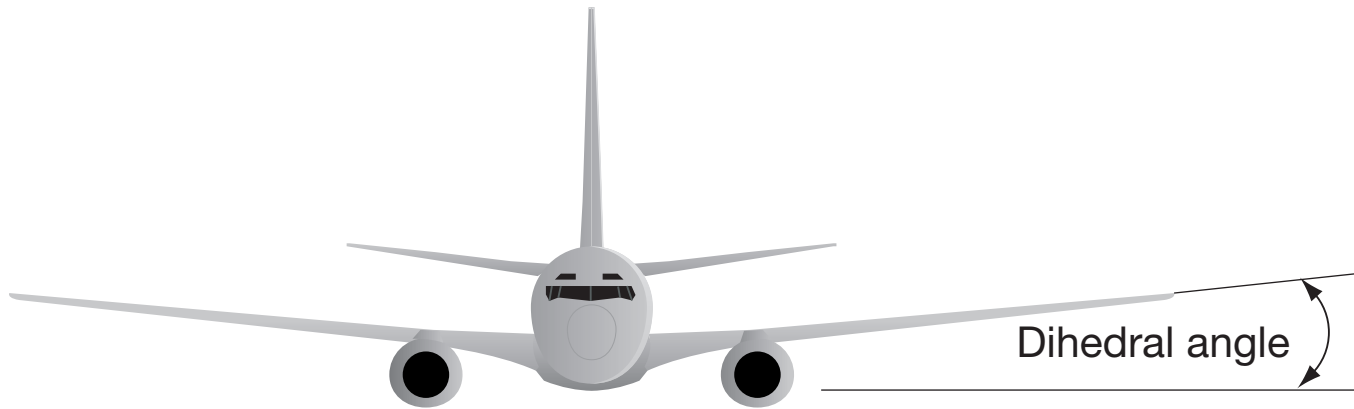

Figure 3-B.43

## Pilot-Commanded Sideslip

The rudders on modern transport jets are sized to counter the yawing moment associated with engine failure at very low takeoff speeds. It is important to realize that these powerful rudder inputs are available whether or not an engine has failed. Large rolling moments are possible through the rudder. “Crossover speed” is a recently coined term that describes the lateral controllability of an airplane with rudder at a fixed (up to maximum) deflection. It is the minimum speed (weight and configuration dependent) in 1-g flight where maximum aileron/spoiler input is reached and the wings are still level or at an angle to maintain directional control. Any additional rudder input or decrease in speed will result in an unstoppable roll into the direction of the deflected rudder. Crossover speed is weight and configuration dependent, but more importantly, it is sensitive to angle of attack. The crossover speed will increase with increased angle of attack. In an airplane upset due to rudder deflection with large and increasing bank angle and the nose rapidly falling below the horizon, the input of additional noseup elevator with already maximum input of aileron/spoilers will only aggravate the situation. The correct action is to unload the airplane to reduce the angle of attack to regain aileron/spoiler effectiveness. This action may not be intuitive and will result in a loss of altitude.

The rudder should not normally be used to induce roll through sideslip because transient sideslip can induce very rapid roll rates with significant time delay. The combination of rapid roll rates and the delay can startle the pilot, which in turn can cause the pilot to overreact in the opposite direction. The overreaction can induce abrupt yawing movements and violent out-of-phase roll rates, which can lead to successive cyclic rudder deflections, known as rudder reversals. Rapid full-deflection flight control reversals can lead to loads that can exceed structural design limits.

# Angle of Sideslip

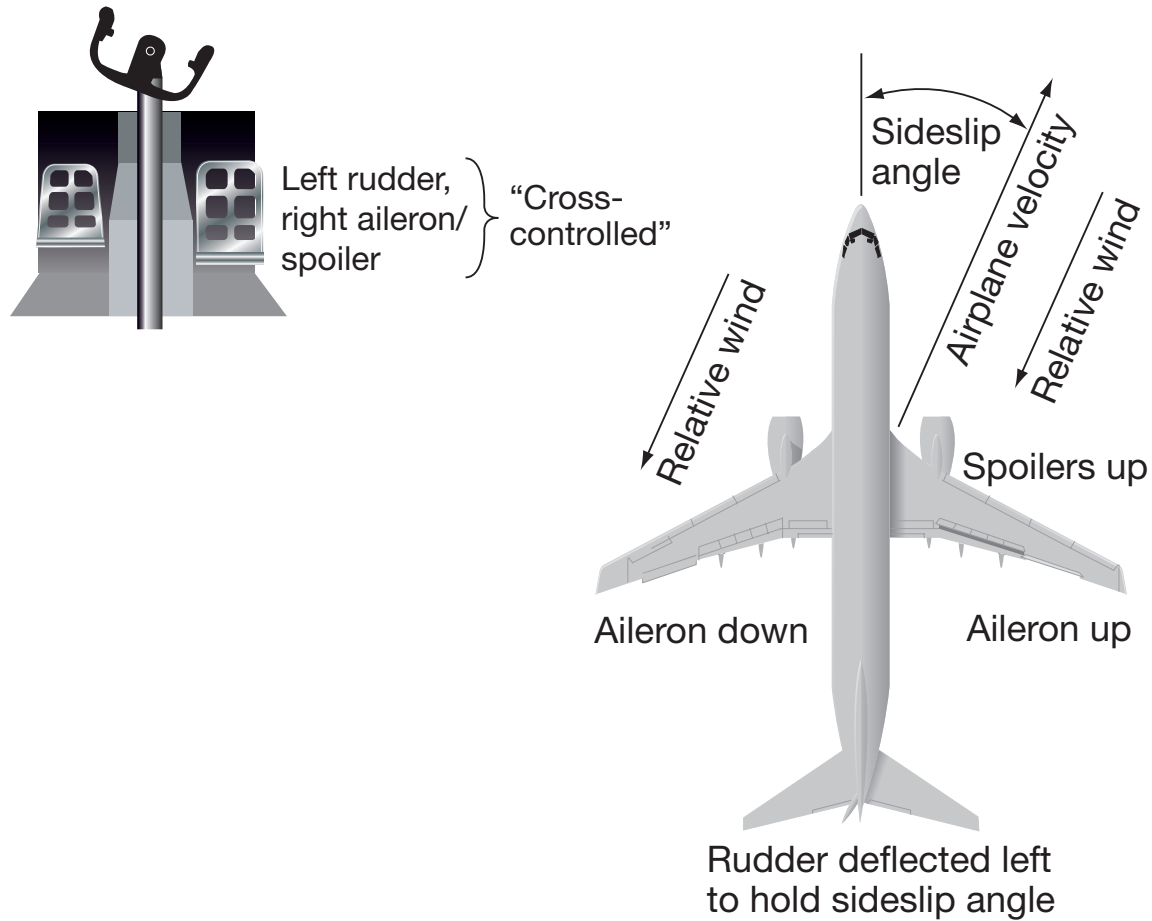

Figure 3-B.44

## High-Speed, High-Altitude Characteristics

Aerodynamic characteristics of lifting surfaces are significantly affected by the ratio of airspeed to the speed of sound (expressed as Mach number). At high altitudes, large Mach numbers exist at relatively low calibrated airspeeds. As Mach number increases, airflow over parts of the airplane begins to exceed the speed of sound. Shock waves, associated with this local supersonic flow, can interfere with the normally smooth flow over the lifting surfaces. Depending on the airplane, characteristics such as pitchup, pitchdown, or aerodynamic buffeting may occur. The point at which buffeting would be expected to occur is documented in the AFM. A sample chart is shown here. Some airplanes have broad speed margins; some have abrupt high-speed buffet margins; and some have narrow, “peaky” characteristics, as depicted here. Pilots should become familiar with the buffet boundaries. These boundaries let the pilot know how much maneuvering room is available.

- Airplane A has wide speed range but narrow g.
- Airplane B has narrow speed range but larger g.
- Airplane C has greater margin at slower speeds.



# High-Speed, High-Altitude Characteristics

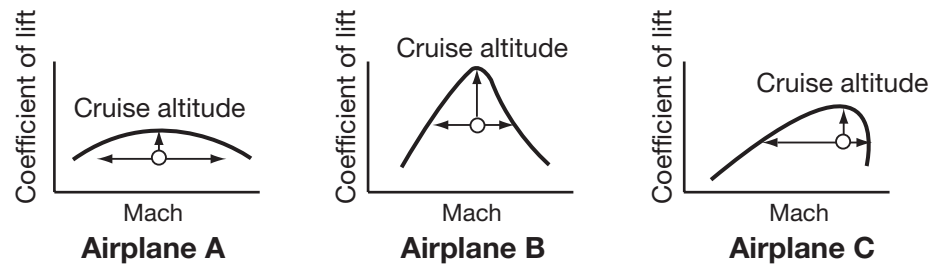
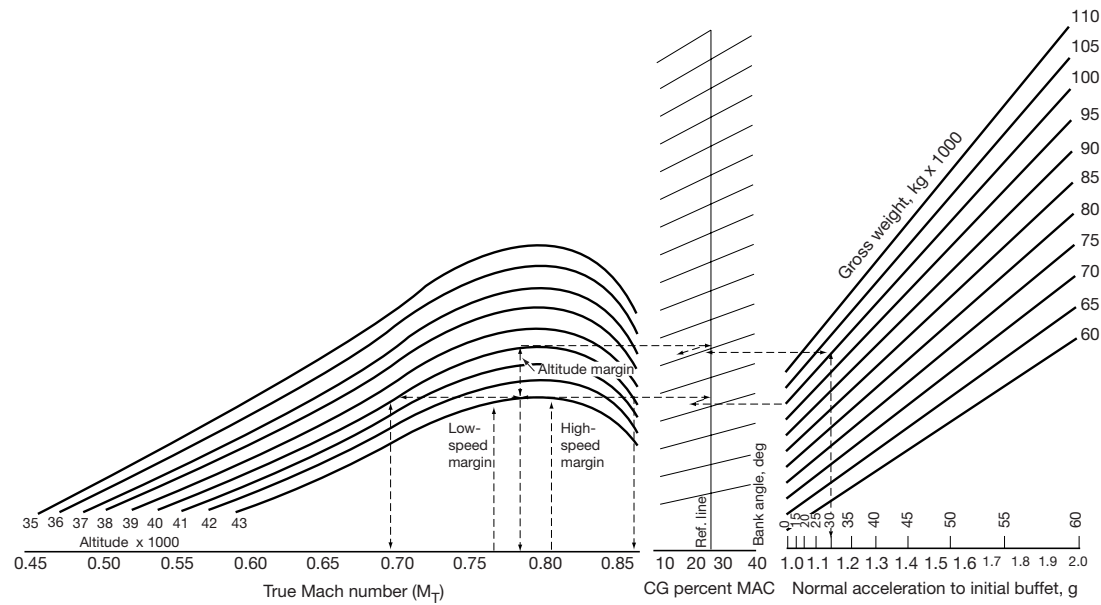

Figure 3-B.45

## Static Stability

Positive static stability is defined as the initial tendency to return to an undisturbed state after a disturbance. This concept is illustrated here and can apply to a number of different parameters, all at the same time. These include, but are not limited to

- Speed stability: returning to initial trim airspeed after a disturbance.
- Mach number stability: maintaining Mach number although speed changes.
- Load factor stability: returning to trimmed g load if disturbed.

Two important aspects of stability are that it

1. Allows for some unattended operation.
2. Gives tactile feedback to the pilot.

For example, if the pilot is holding a sustained pull force, the speed is probably slower than the last trim speed.

# Static Stability

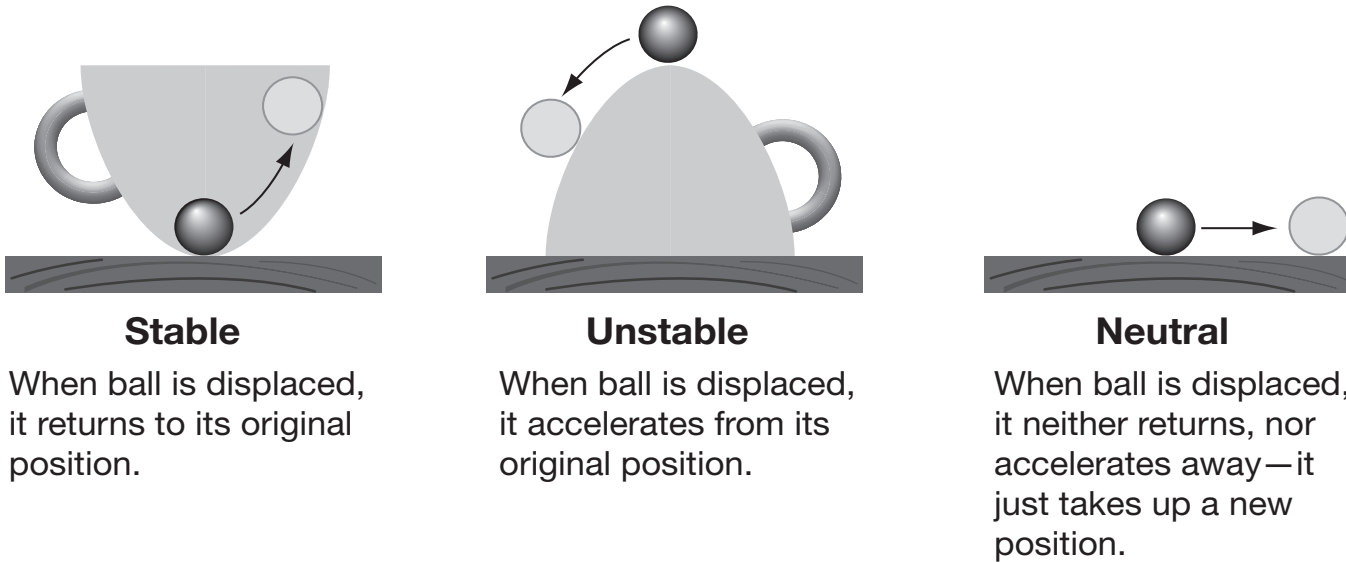
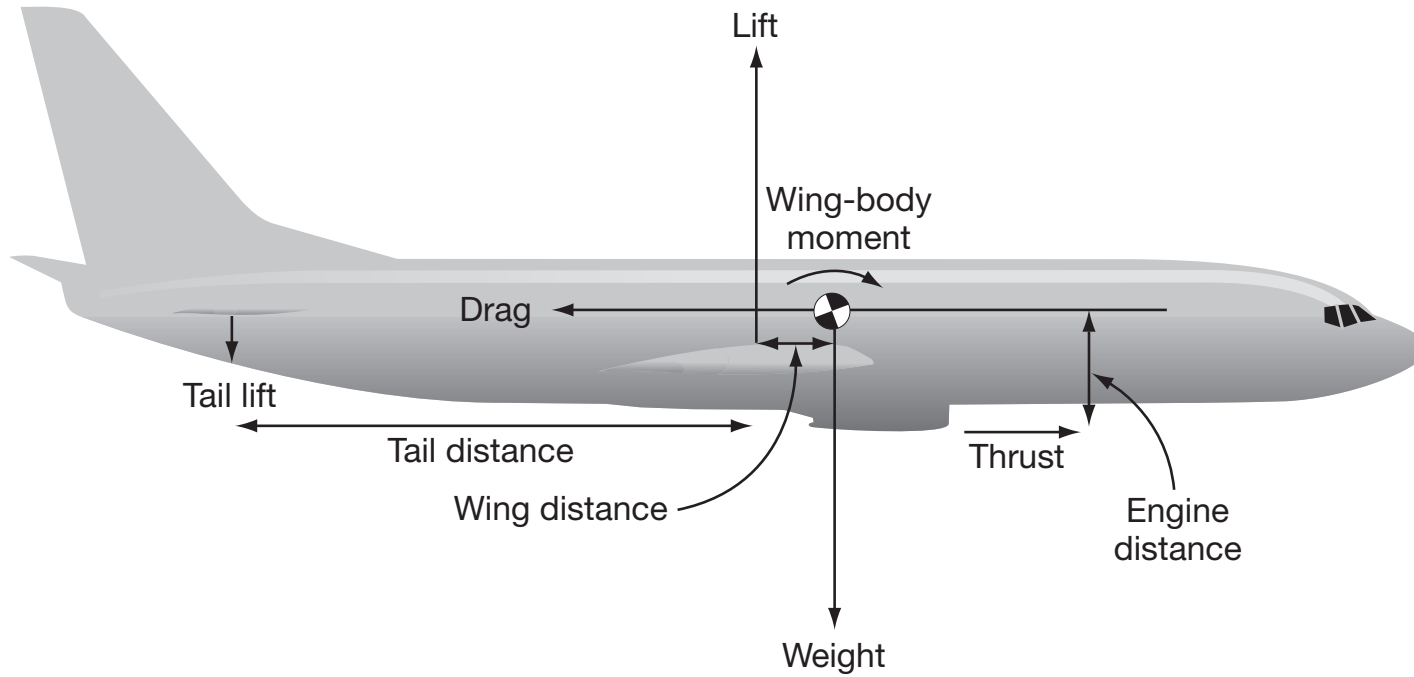

Figure 3-B.46

## Maneuvering in Pitch

Controlling pitching motions involves controlling aerodynamic and other moments about the center of gravity to modulate the angle of attack. Other than thrust moments, the pilot controls the pitching moments (angle of attack) by means of the stabilizer and elevator. Moments have dimensions of force times distance. We are concerned with moments about the center of gravity. The various pitching moments, and how they are calculated, are shown here. In steady flight, the moments about the center of gravity, as well as the forces, are all balanced. The difference between the center of gravity and the center of lift is balanced by tail loading. Essentially, the pilot controls the amount of lift generated by the horizontal tail by moving the elevator, which adjusts the angle of attack and modulates the amount of lift that the wing generates. Engines are rarely aligned with the center of gravity; therefore, pitching moments will be created with changes in thrust. As long as the angle of attack is within unstalled limits and the airspeed is within limits, the aerodynamic controls will work to maneuver the airplane in the pitch axis as described. This is true regardless of the attitude of the airplane or the orientation of the weight vector.

# Maneuvering in Pitch



$$\begin{aligned}
 & \text{(Moment)}_{\text{Tail}} + \text{(Moment)}_{\text{Lift}} + \text{(Moment)}_{\text{Thrust}} + \text{(Moment)}_{\text{Wing-body}} = \text{Total pitching moment} \\
 & \left( \text{Tail lift} * \text{Tail distance} \right) + \left( \text{Wing lift} * \text{Wing distance} \right) + \left( \text{Thrust} * \text{Engine distance} \right) + \text{(Moment)}_{\text{Wing-body}} = \text{Total pitching moment}
 \end{aligned}$$

Figure 3-B.47

## Mechanics of Turning Flight

Recalling Newton's second law, that an object in motion will continue in a straight line unless acted on by an external force, consider what is required to make an airplane turn. A force perpendicular to the flight path, in the direction of turn, is required. As depicted, part of the lift vector is lost, and there is an imbalance in forces. Unless the lift vector is increased, so that its vertical component equals the weight of the airplane, the aircraft will begin to accelerate toward the Earth (descend). All of this is well-known to pilots, but it bears reiteration in the context of recovery from extreme airplane upsets. If the objective is to arrest descent, maneuvering in pitch if the wings are not level will only cause a tighter turn and, depending on the bank angle, may not contribute significantly to generating a lift vector that points away from the ground. Indeed, to maintain level flight at bank angles beyond 66 deg requires a larger load factor than 2.5 g. Knowledge of these relationships is useful in other situations as well. In the event that the load factor is increasing, excess lift is being generated, and the pilot does not want the speed to decrease, bank angle can help to keep the flight path vector below the horizon, getting gravity to help prevent loss of airspeed. The excess lift can be oriented toward the horizon and, in fact, modulated up and down to maintain airspeed.

# Mechanics of Turning Flight

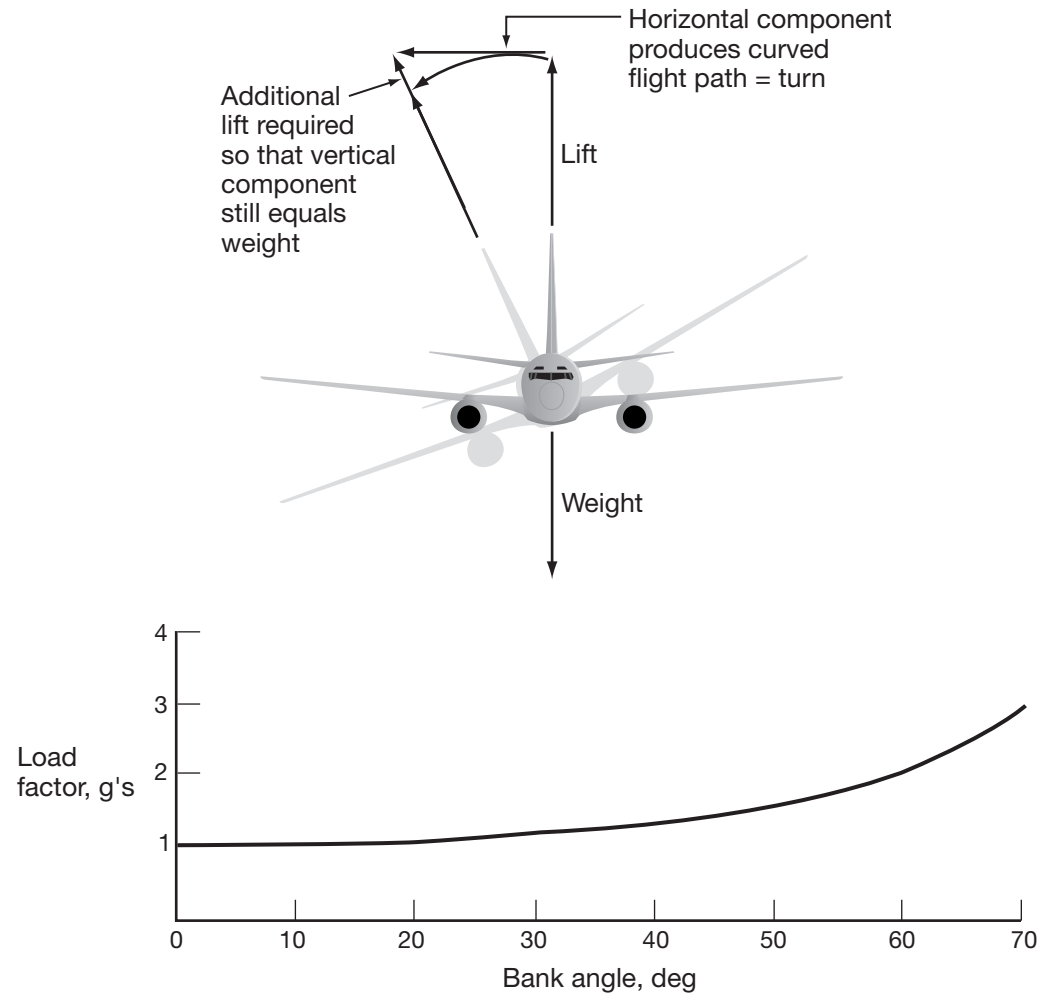

Figure 3-B.48

## Lateral Maneuvering

Motion about the longitudinal axis is called roll. On modern jet airplanes, the specific deflection combinations of ailerons and spoilers are designed to make adverse yaw virtually undetectable to the pilot. As discussed before, trailing edge control surfaces lose effectiveness in the downward direction at high angles of attack. Spoilers also lose their effectiveness as the stall angle of attack is exceeded. Transport aircraft are certificated to have the capability of producing and correcting roll up to the time the airplane is stalled. Beyond the stall angle, no generalizations can be made. For this reason, it is critical to reduce the angle of attack at the first indication of stall so that control surface effectiveness is preserved. As discussed before, airplanes of large mass and large inertia require that pilots be prepared for longer response time and plan appropriately.



# Lateral Maneuvering—Roll Axis

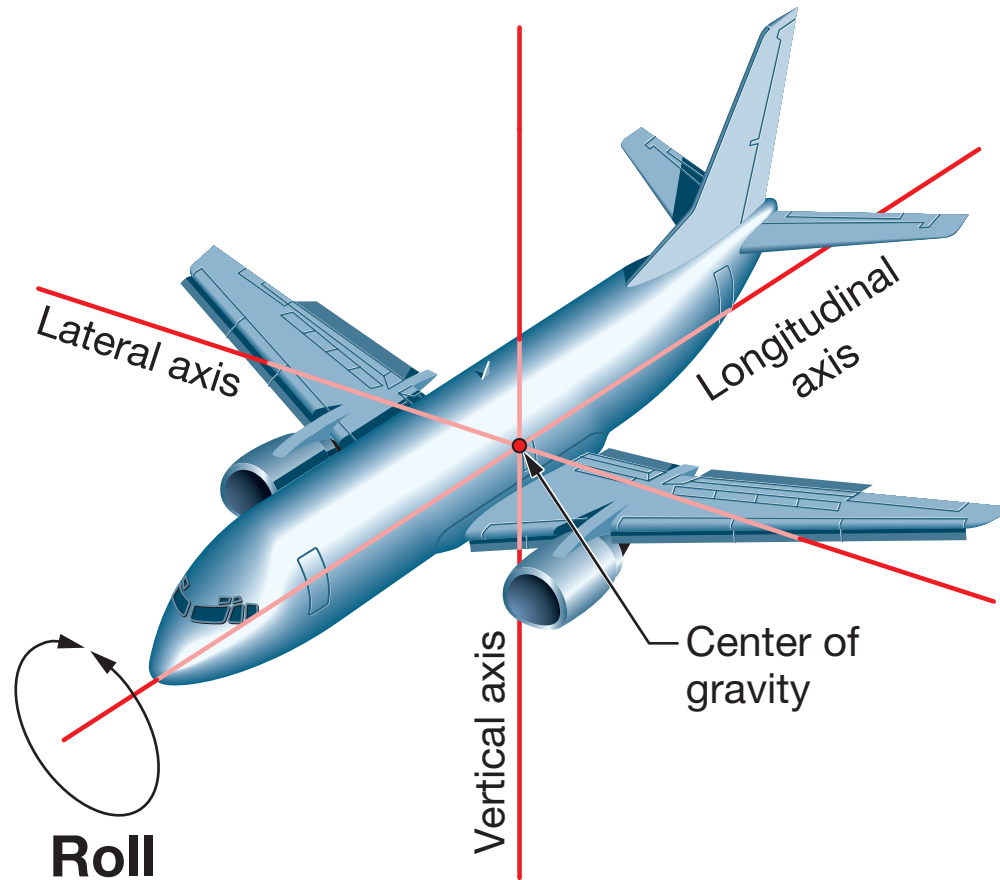

Figure 3-B.49

## Lateral Maneuvering—Flight Dynamics

From a flight dynamics point of view, the greatest power of lateral control in maneuvering the airplane—using available energy to maneuver the flight—is to orient the lift vector. In particular, pilots need to be aware of their ability to orient the lift vector with respect to the gravity vector. Upright with wings level, the lift vector is opposed to the gravity vector, and the vertical flight path is controlled by longitudinal control and thrust. Upright with the wings not level, the lift vector is not aligned with gravity, and the flight path will be curved in the downward direction if the g force is not increased above 1. In all cases, the pilot should ensure that the angle of attack is below the stall angle and roll to upright as rapidly as possible.

# Lateral Maneuvering—Flight Dynamics

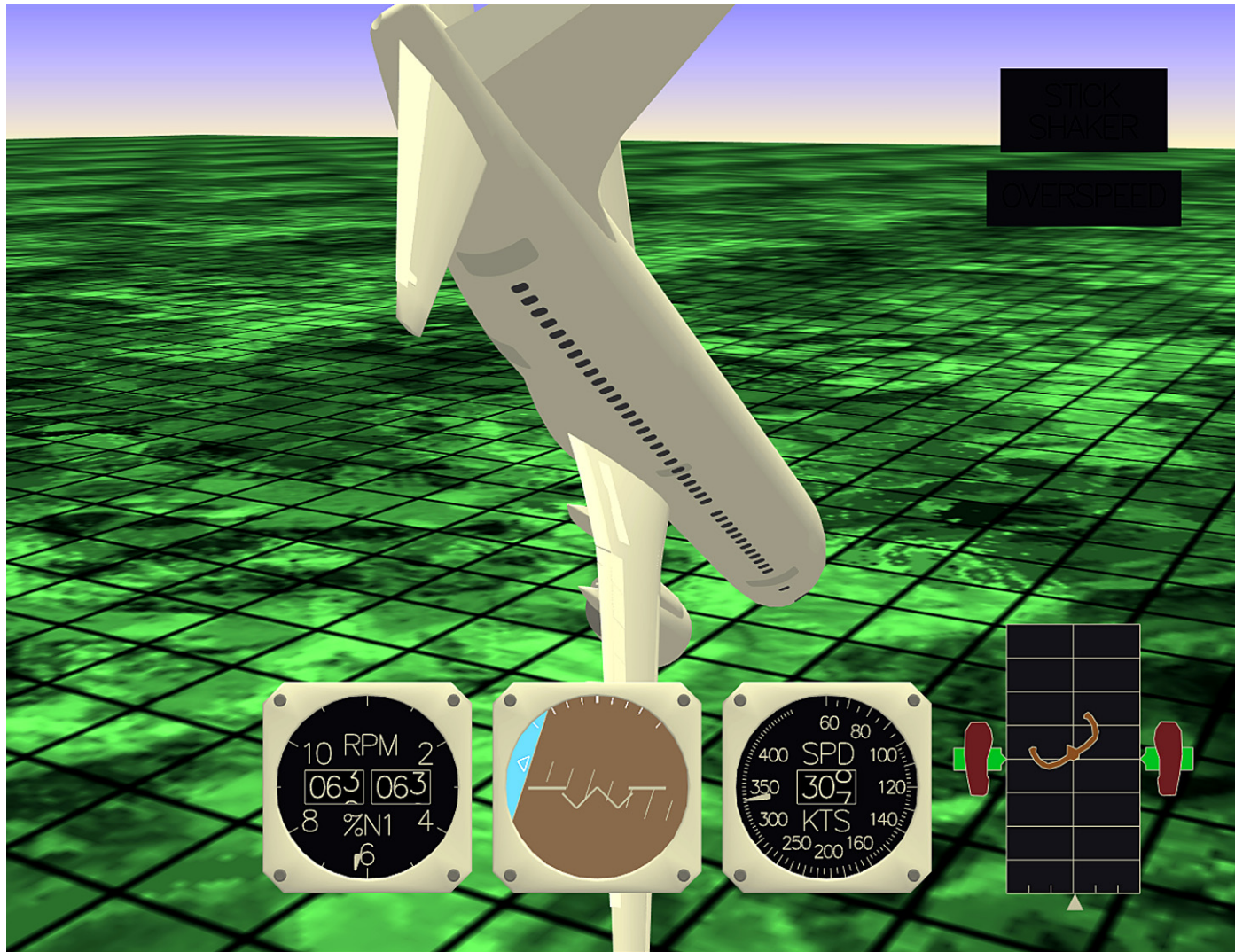

Figure 3-B.50

## Directional Maneuvering

Motion about the vertical axis is called yaw. The principal controller of aerodynamic moments about the vertical axis is the rudder, but it is not the only one. Others include asymmetric thrust and asymmetric drag. Generally, the rudder is used to control yaw in a way that minimizes sideslip. On modern jet transports with powerful engines located away from the centerline, engine failure can result in very large yawing moments. Rudders are sized to cope with these moments down to very low speeds. In a condition of no engine failure, very large yawing moments would result in very large sideslip angles and large structural loads, should the pilot input full rudder when it is not needed. There are a few cases, however, when it is necessary to generate sideslip—crosswind landing, for example. Although stability in the directional axis tends to drive the sideslip angle toward zero, without augmented stability (yaw damping) the inertial and aerodynamic characteristics of modern jet transports would produce a rolling and yawing motion known as “Dutch roll.” The pilot, with manual control over rudder deflection, is the most powerful element in the system.

# Directional Maneuvering—Yaw Axis

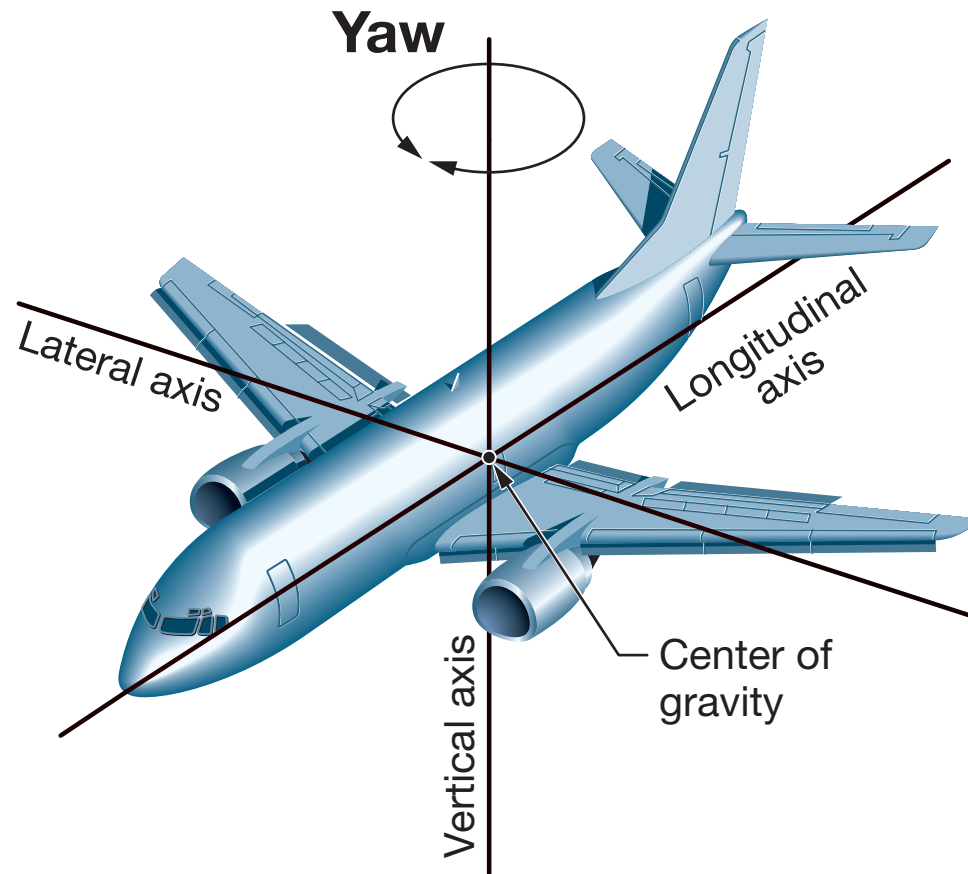

Figure 3-B.51

## Flight at Extremely Low Airspeeds

It is possible for the airplane to be flown at speeds below the defined stall speed. This regime is outside the certified flight envelope. At extremely low airspeed, there are several important effects for the pilot to know about. Lift generated by wings and tails depends on both the angle of attack and the velocity of the air moving over the surfaces. At very low airspeeds, an unstalled surface will produce lift. The lift generated may not be enough to support the weight of the airplane. In the case of the lift generated by the tail, at very low airspeed, it may not be great enough to trim the airplane, that is, to keep it from pitching. The trajectory will be largely ballistic, and it may be difficult to command a change in attitude until gravity produces enough airspeed to generate sufficient lift—that is only possible at angles of attack below the stall angle. For this reason, if airspeed is decreasing rapidly, it is very important to reduce angle of attack and use whatever aerodynamic forces are available to orient the airplane so that a recovery may be made when sufficient forces (airspeed) are available.

# Flight at Extremely Low Airspeeds



Figure 3-B.52

## Flight at Extremely Low Airspeeds (continued)

The situation becomes only slightly more complicated when thrust is considered. With engines offset from the center of gravity, thrust produces both forces and moments. As airspeed decreases, engine thrust generally increases for a given throttle setting. With engines below the center of gravity, there will be a noseup moment generated by engine thrust. Especially at high power settings, this may contribute to even higher noseup attitudes and even lower airspeeds.

Pilots should be aware that, as aerodynamic control effectiveness diminishes with lower airspeeds, the forces and moments available from thrust become more evident, and until the aerodynamic control surfaces become effective, the trajectory will depend largely on inertia and thrust effects.



# Flight at Low Airspeeds and Thrust Effects



Figure 3-B.53

## Flight at Extremely High Speeds

Inadvertent excursions into extremely high speed, either Mach or airspeed, should be treated very seriously. Flight at very high Mach numbers puts the airplane in a region of reduced maneuvering envelope. Pilots need to be aware that the envelope is small. Prudent corrective action is necessary to avoid exceeding limits at the other end of the envelope, should an inadvertent excursion occur. Flight in the high-air-speed regime brings with it an additional consideration of very high control power. At speeds higher than maneuver speed, very large deflection of the controls has the potential to generate structural damage.

In either the Mach or airspeed regime, if speed is excessive, the first priority should be to reduce speed to within the normal envelope. Many tools are available for this, including orienting the lift vector away from the gravity vector; adding load factor, which increases drag; reducing thrust; and adding drag by means of the speedbrakes. The single most powerful force the pilot has available is the wing lift force. The second largest force acting on the airplane is the weight vector. Getting the airplane maneuvered so that the lift vector points in the desired direction should be the first priority, and it is the first step toward managing the energy available in the airplane.

# Flight at Extremely High Speeds



Figure 3-B.54

## Summary of Swept-Wing Fundamentals for Pilots

- Flight dynamics: Newton's laws.
- Energy states: kinetic, potential, and chemical.
- Load factors: longitudinal, lateral, and vertical.
- Aerodynamic flight envelope: operating and demonstrated speeds.
- Aerodynamics: the relationship of angle of attack and stall.

# Summary of Swept-Wing Fundamentals

- **Flight dynamics: Newton's laws**
- **Energy states: kinetic, potential, and chemical**
- **Load factors: longitudinal, lateral, and vertical**
- **Aerodynamic flight envelope: operating and demonstrated speeds**
- **Aerodynamics: the relationship of angle of attack and stall**

## Recovery From Airplane Upsets

The first part of the briefing was devoted to the causes of airplane upsets. We had a brief review of how and why large, swept-wing airplanes fly. That information provides the foundation of knowledge necessary for recovering an airplane that has been upset. This section highlights several issues associated with airplane upset recovery and presents basic recommended airplane recovery techniques.

# Airplane Upset Recovery

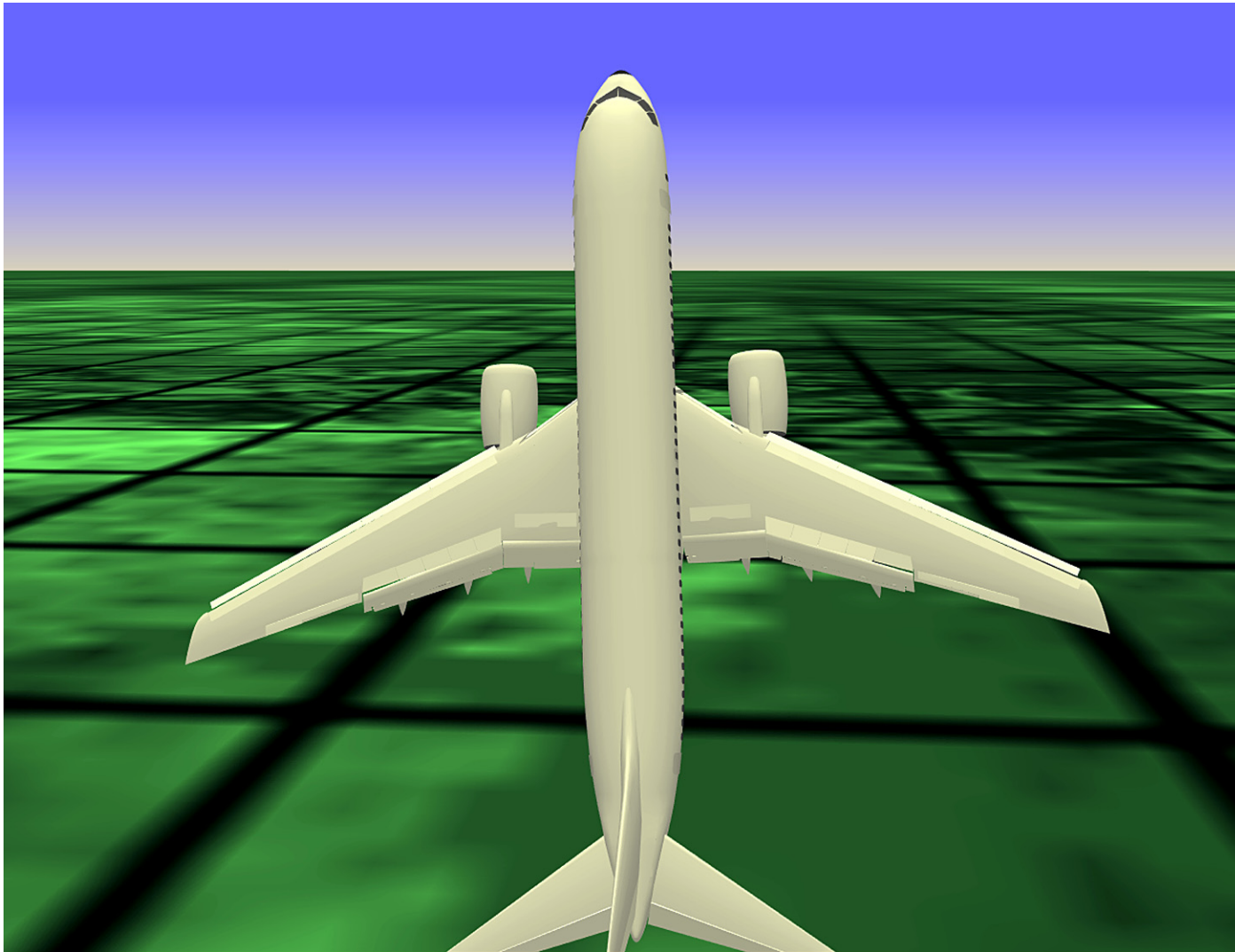

Figure 3-B.56

## Situational Awareness During an Airplane Upset

It is important that the first actions be correct and timely. Guard against letting the recovery from one upset lead to a different upset situation. Troubleshooting the cause of the upset is secondary and can wait. Use the primary flight instruments. Darkness, weather conditions, and the limited view from the cockpit will make it difficult to effectively use the horizon. The attitude direction indicator (ADI) is used as a primary reference.

Situation Analysis Process:

- Communicate with crew members.
- Locate the bank indicator.
- Determine pitch attitude.
- Confirm attitude by reference to other indicators.
- Assess the energy state.

The phrase “recognize and confirm the situation” will be used frequently in discussing recovery techniques. The process outlined above is used to accomplish this.



# **Situational Awareness During an Airplane Upset**

**“Recognize and confirm the situation” by the following key steps:**

- **Communicate with crew members**
- **Locate the bank indicator**
- **Determine pitch attitude**
- **Confirm attitude by reference to other indicators**

## Miscellaneous Issues Associated With Upset Recovery

Pilots who have experienced an airplane upset have identified several issues associated with recovering from an upset. Observations of pilots in a simulator-training environment have also revealed useful information associated with recovery.

# **The Miscellaneous Issues Associated With Upset Recovery Have Been Identified by**

- **Pilots who have experienced an airplane upset**
- **Pilot observations in a simulator-training environment**

**And they are associated with**

- **The startle factor**
- **Negative g force**
- **Full control inputs**
- **Counter-intuitive factors**

## Startle Factor

Airplane upsets are infrequent; therefore, pilots are usually surprised or startled when an upset occurs. There is a tendency to react before analyzing what is happening or to fixate on one indication and fail to properly diagnose the situation.

# Startle Factor

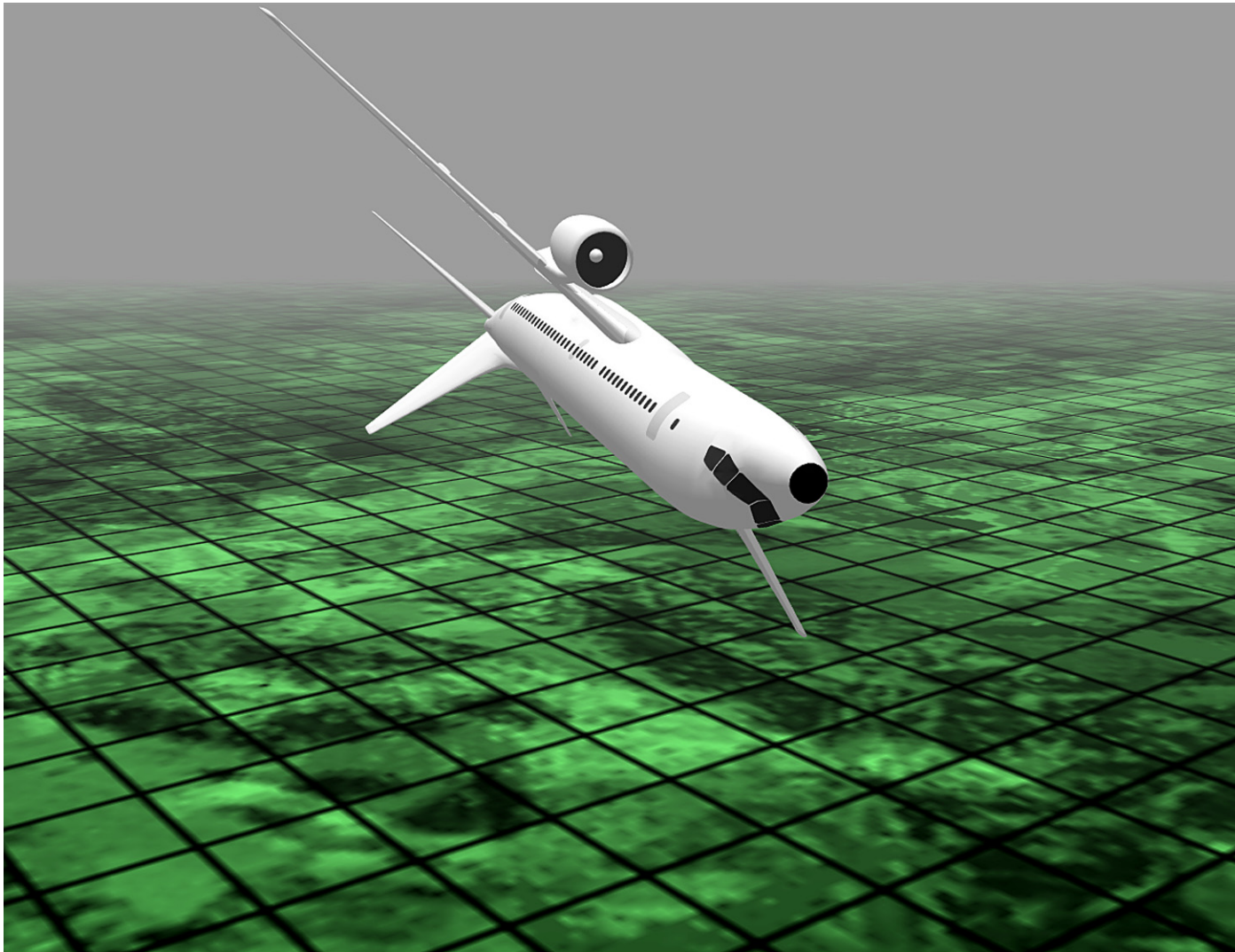

Figure 3-B.59

## Negative G Force

Airline pilots are normally uncomfortable (for the sake of passenger comfort and safety) with aggressively unloading the g forces on a large passenger airplane. This inhibition must be overcome when faced with the necessity to quickly and sometimes aggressively unload the airplane to less than 1 g. Most simulators cannot replicate sustained negative g forces; therefore, the cockpit situation must be envisioned during less than 1-g flight. You may be floating up against the shoulder harness and seat belt. It may be difficult to reach the rudder pedals. Unsecured items may be flying around the cockpit. It should be emphasized that it should not normally be necessary to obtain less than 0 g.

# Negative G Force

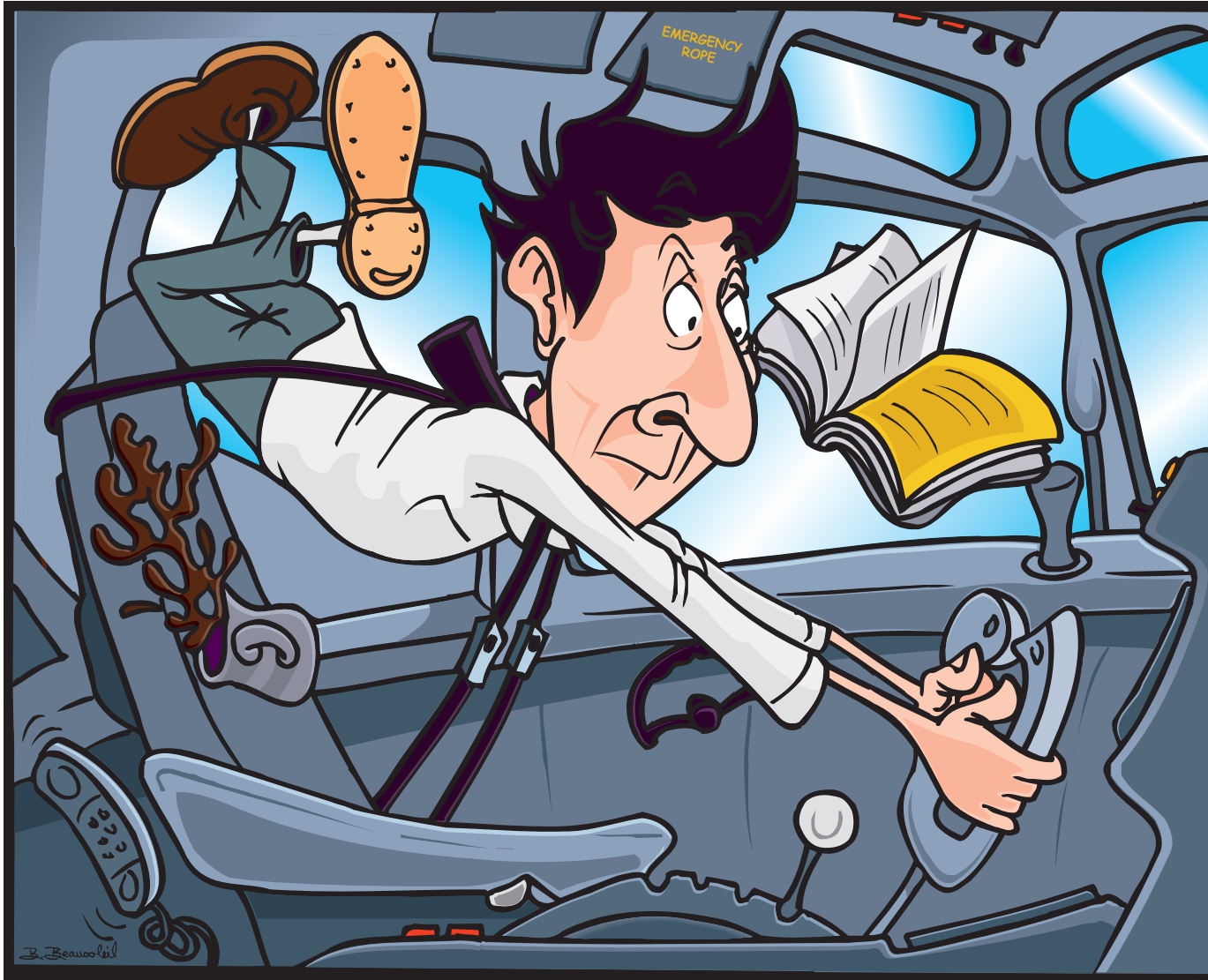

Figure 3-B.60

## Use of Full Control Inputs

Flight control forces become less effective when the airplane is at or near its critical angle of attack or stall. The tendency is for pilots not to use full control authority because they rarely are required to do so. This habit must be overcome when recovering from severe upsets.



# Use of Full Control Inputs



Figure 3-B.61

## Nonintuitive Factors

Pilots are routinely trained to recover from approach to stalls. The recovery routinely requires an increase in thrust and a relatively small reduction in pitch attitude. It may be counter-intuitive to use greater unloading control forces or to reduce thrust when recovering from a high angle of attack, especially at low altitudes. If the airplane is stalled while already in a nosedown attitude, the pilot must still push the nose down (unload) in order to reduce the angle of attack. Altitude cannot be maintained in a stall and should be of secondary importance.

# Nonintuitive Factors



Figure 3-B.62

## Airplane Upset Recovery Techniques

The following airplane upset situations will be discussed:

- Nose high, wings level.
- Nose low, wings level.
- High bank angles.
  - Nose high.
  - Nose low.

At the conclusion, recommended recovery techniques are summarized into two basic airplane upset situations:

- Nose high.
- Nose low.

# **Airplane Upset Recovery Techniques Will Include a Review of the Following Airplane Upset Situations:**

- **Nose high, wings level**
- **Nose low, wings level**
- **High bank angles:**
  - **Nose high**
  - **Nose low**
- **And a review of recommended upset recovery techniques based on two basic airplane upset situations:**
  - **Nose high**
  - **Nose low**

## Airplane Upset Recovery Techniques (continued)

Recovery techniques assume that the airplane is not stalled. If the airplane is stalled, it is imperative to first recover from the stalled condition before initiating the upset recovery technique. Do not confuse an approach to stall and a full stall. An approach to stall is controlled flight. An airplane that is stalled is out of control but can be recovered. A stall is characterized by any, or a combination of, the following:

- Buffeting, which could be heavy at times.
- A lack of pitch authority.
- A lack of roll control.
- Inability to arrest descent rate.

To recover from a stall, the angle of attack must be reduced below the stalling angle. Apply nosedown pitch control and maintain it until stall recovery. Under certain conditions with underwing-mounted engines, it may be necessary to reduce thrust to prevent the angle of attack from continuing to increase. *Remember, in an upset situation, if the airplane is stalled, it is first necessary to recover from the stall before initiating upset recovery techniques.*

# Airplane Upset Recovery Techniques

- **Stall characteristics**
  - **Buffeting**
  - **Lack of pitch authority**
  - **Lack of roll control**
  - **Inability to arrest descent rate**

## Nose-High, Wings-Level Recovery Techniques

Situation: Pitch attitude unintentionally more than 25 deg, nose high, and increasing; airspeed decreasing rapidly; ability to maneuver decreasing.

- Recognize and confirm the situation.
- Disengage autopilot and autothrottle.
- Apply as much as full nosedown elevator.
- Use appropriate techniques:
  - Roll to obtain a nosedown pitch rate.
  - Reduce thrust (underwing-mounted engines).
- Complete the recovery:
  - Approaching horizon, roll to wings level.
  - Check airspeed and adjust thrust.
  - Establish pitch attitude.



# Nose-High, Wings-Level Recovery Techniques

- Recognize and confirm the situation
- Disengage autopilot and autothrottle



Figure 3-B.65

## Nose-High, Wings-Level Recovery Techniques

Situation: Pitch attitude unintentionally more than 25 deg, nose high, and increasing; airspeed decreasing rapidly; ability to maneuver decreasing.

- Apply as much as full nosedown elevator.
- Use nosedown stabilizer trim should stick forces be high.

# Nose-High, Wings-Level Recovery Techniques



Figure 3-B.66

## Nose-High, Wings-Level Recovery Techniques

Situation: Pitch attitude unintentionally more than 25 deg, nose high, and increasing; airspeed decreasing rapidly; ability to maneuver decreasing.

- Use appropriate techniques:
  - Roll to obtain a nosedown pitch rate.

# Nose-High, Wings-Level Recovery Techniques

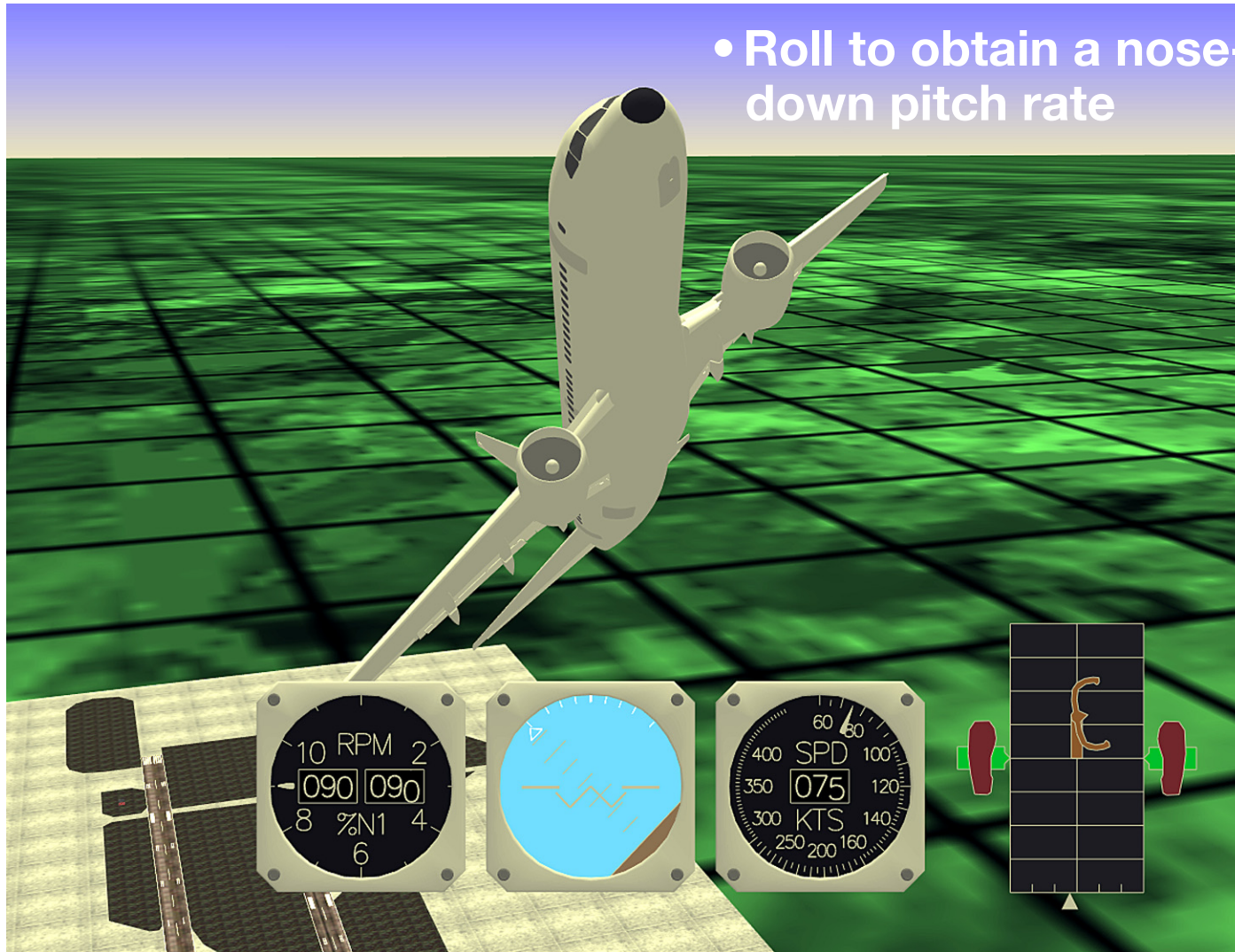

Figure 3-B.67

## Nose-High, Wings-Level Recovery Techniques

Situation: Pitch attitude unintentionally more than 25 deg, nose high, and increasing; airspeed decreasing rapidly; ability to maneuver decreasing.

- Use appropriate techniques: reduce thrust (underwing-mounted engines).

# Nose-High, Wings-Level Recovery Techniques

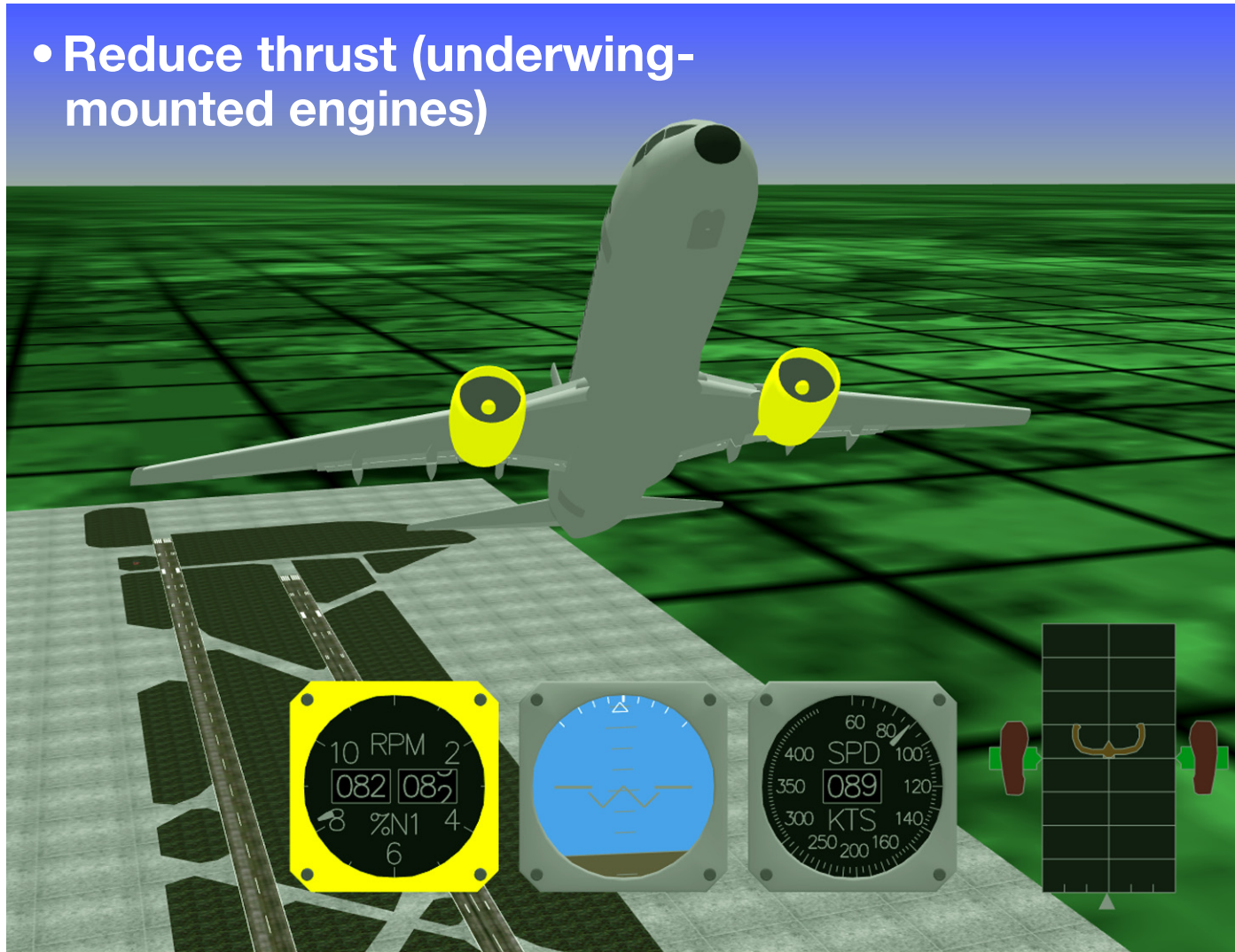

Figure 3-B.68

## Nose-High, Wings-Level Recovery Techniques

Situation: Pitch attitude unintentionally more than 25 deg, nose high, and increasing; airspeed decreasing rapidly; ability to maneuver decreasing.

- Complete the recovery:
  - Approaching horizon, roll to wings level.
  - Check airspeed and adjust thrust.
  - Establish pitch attitude.



# Nose-High, Wings-Level Recovery Techniques

- Complete the recovery:
  - Approaching horizon, roll to wings level
  - Check airspeed and adjust thrust
  - Establish pitch attitude

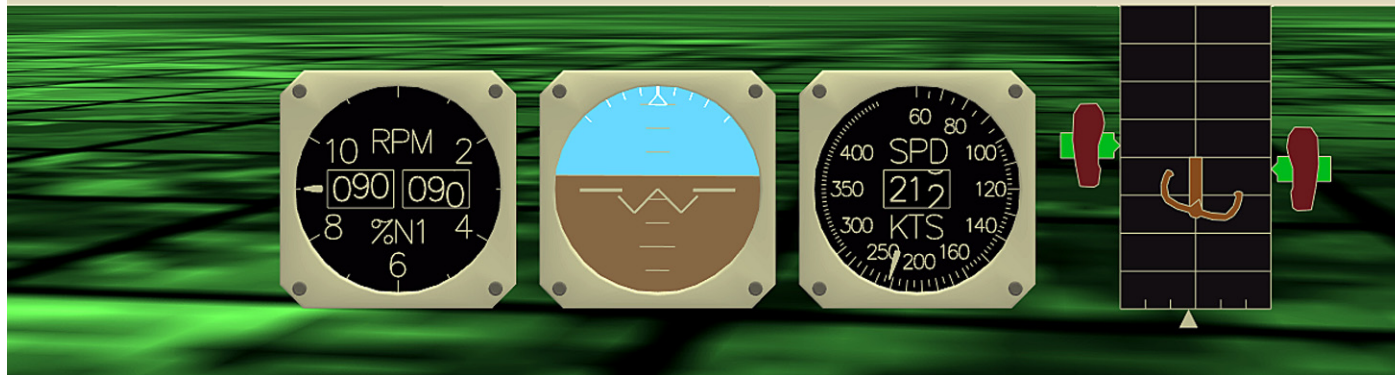

Figure 3-B.69

## Nose-Low, Wings-Level Recovery Techniques

Situation: Pitch attitude unintentionally more than 10 deg, nose low.

- Recognize and confirm the situation.
- Disengage autopilot and autothrottle.
- Recover from stall, if necessary.
- Recover to level flight.
  - Apply noseup elevator.
  - Apply stabilizer trim, if necessary.
  - Adjust thrust and drag, as necessary.

# Nose-Low, Wings-Level Recovery Techniques



- **Recognize and confirm the situation**

Figure 3-B.70

## Nose-Low, Wings-Level Recovery Techniques

Situation: Pitch attitude unintentionally more than 10 deg, nose low.

- Disengage autopilot and autothrottle.

# Nose-Low, Wings-Level Recovery Techniques



- Disengage autopilot and autothrot-

Figure 3-B.71

## Nose-Low, Wings-Level Recovery Techniques

Situation: Pitch attitude unintentionally more than 10 deg, nose low.

- Recover from stall, if necessary.

# Nose-Low, Wings-Level Recovery Techniques

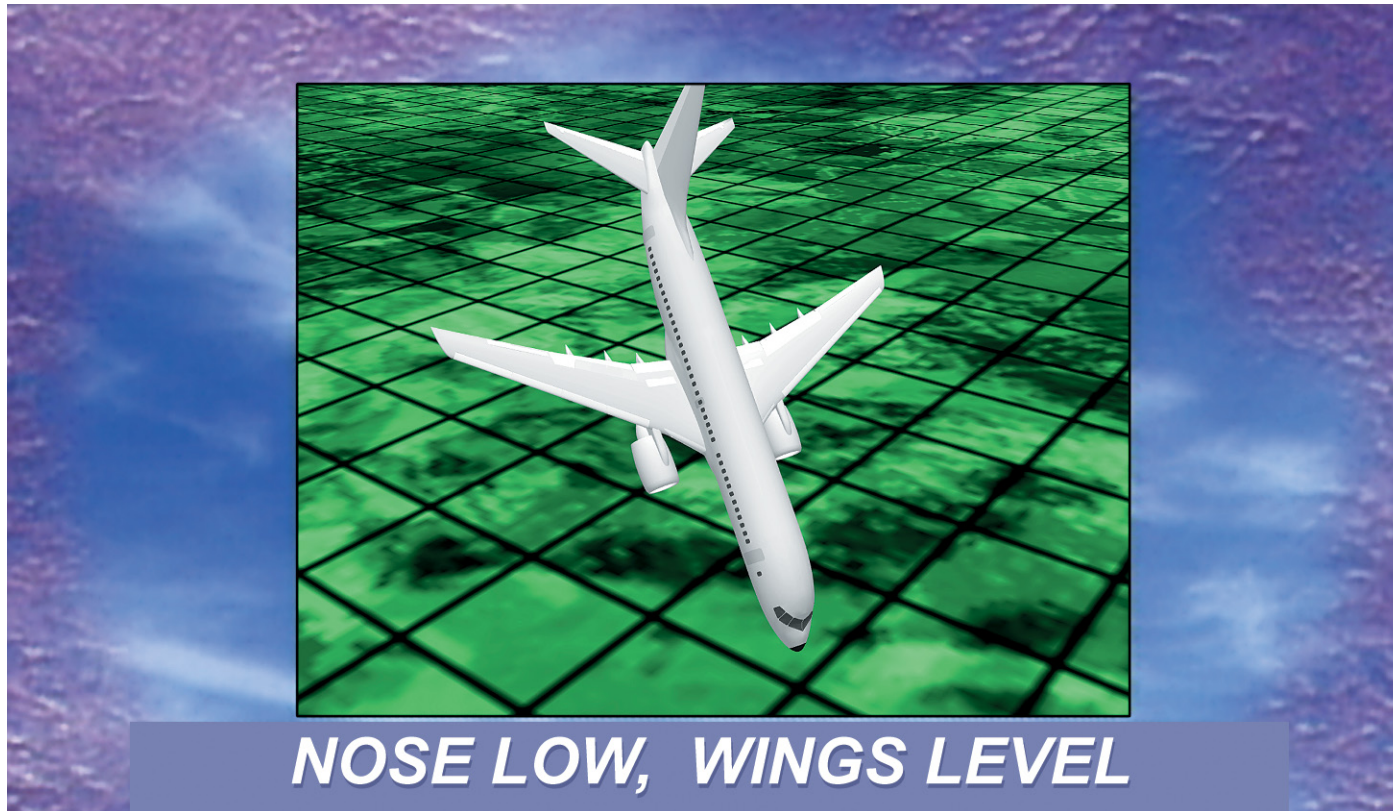

- **Recover from stall, if necessary**

Figure 3-B.72

## Nose-Low, Wings-Level Recovery Techniques

Situation: Pitch attitude unintentionally more than 10 deg, nose low.

- Recover to level flight:
  - Apply noseup elevator.
  - Apply stabilizer trim, if necessary.



# Nose-Low, Wings-Level Recovery Techniques

## Recover to Level Flight



- Apply noseup elevator



- Apply stabilizer trim, if necessary

Figure 3-B.73

## Nose-Low, Wings-Level Recovery Techniques

Situation: Pitch attitude unintentionally more than 10 deg, nose low.

- Adjust thrust and drag, as necessary.

# Nose-Low, Wings-Level Recovery Techniques



- Adjust thrust and drag, as necessary

Figure 3-B.74

## High-Bank-Angle Recovery Techniques

Situation: Bank angle greater than 45 deg; pitch attitude greater than 25 deg, nose high.

- Recognize and confirm the situation.
- Disengage autopilot and autothrottle.
- Reduce the angle of attack (unload).
- Adjust the bank angle to achieve a nosedown pitch rate.
- Complete the recovery:
  - Approaching the horizon, roll to wings level.
  - Check airspeed, adjust thrust.
  - Establish pitch attitude.

# High-Bank-Angle Recovery Techniques

- Recognize and confirm the situation
- Disengage autopilot and autothrottle



Figure 3-B.75

## High-Bank-Angle Recovery Techniques

Situation: Bank angle greater than 45 deg; pitch attitude greater than 25 deg, nose high.

- Reduce the angle of attack.
- Adjust the bank angle to achieve a nosedown pitch rate.

# High-Bank-Angle Recovery Techniques

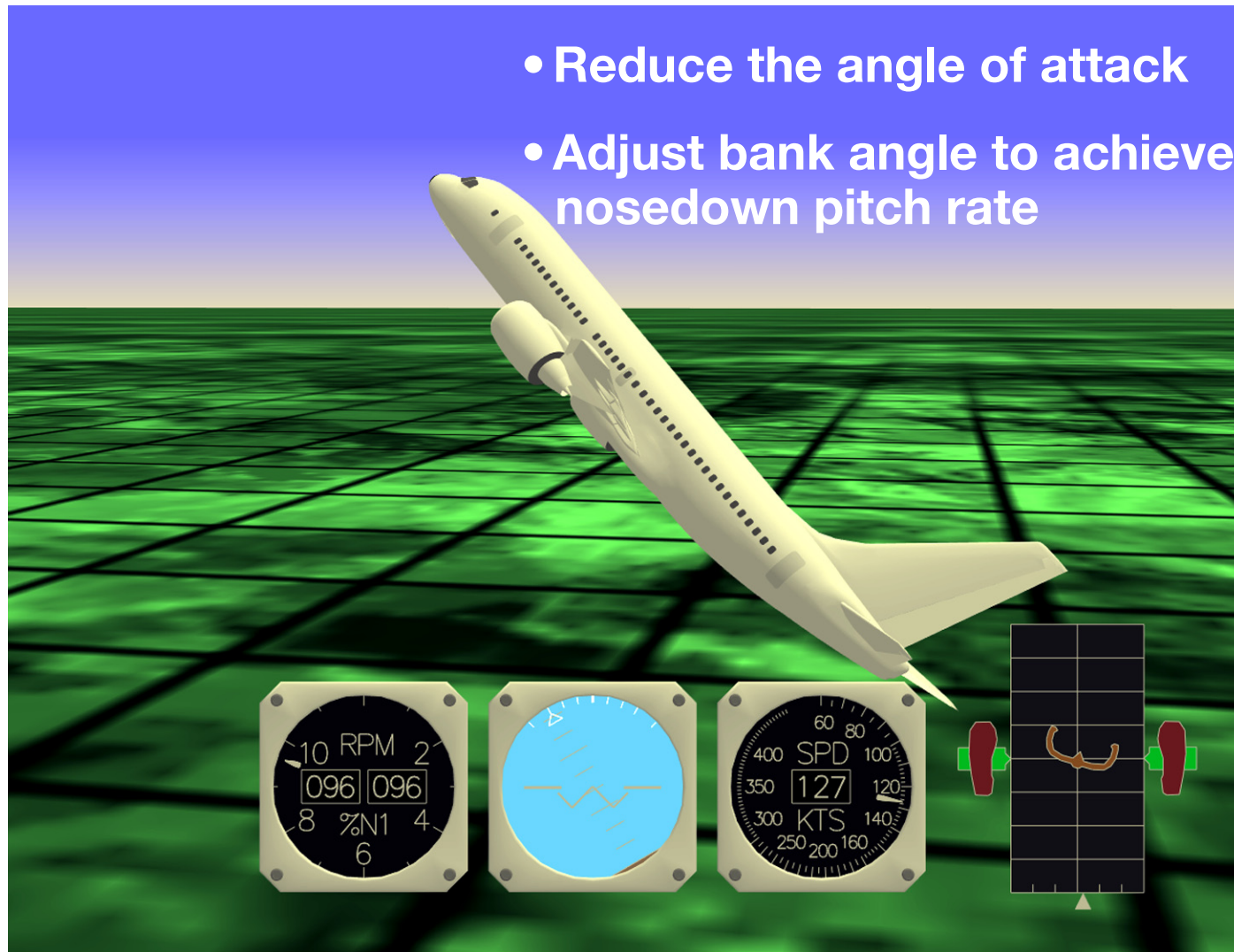

Figure 3-B.76

## High-Bank-Angle Recovery Techniques

Situation: Bank angle greater than 45 deg; pitch attitude greater than 25 deg, nose high.

- Complete the recovery:
  - Approaching the horizon, roll to wings level.
  - Check airspeed; adjust thrust.
  - Establish pitch attitude.



# High-Bank-Angle Recovery Techniques



Figure 3-B.77

## High-Bank-Angle Recovery Techniques

Situation: Bank angle greater than 45 deg; pitch attitude lower than 10 deg; airspeed increasing.

- Recognize and confirm the situation.
- Disengage autopilot and autothrottle.
- Reduce the angle of attack, if necessary.
- Simultaneously reduce thrust and roll the shortest direction to wings level.
- Recover to level flight:
  - Apply noseup elevator.
  - Apply stabilizer trim, if necessary.
  - Adjust thrust and drag, as necessary.

# High-Bank-Angle Recovery Techniques



Figure 3-B.78

## High-Bank-Angle Recovery Techniques

Situation: Bank angle greater than 45 deg; pitch attitude lower than 10 deg; airspeed increasing.

- Reduce the angle of attack, if necessary.

# High-Bank-Angle Recovery Techniques

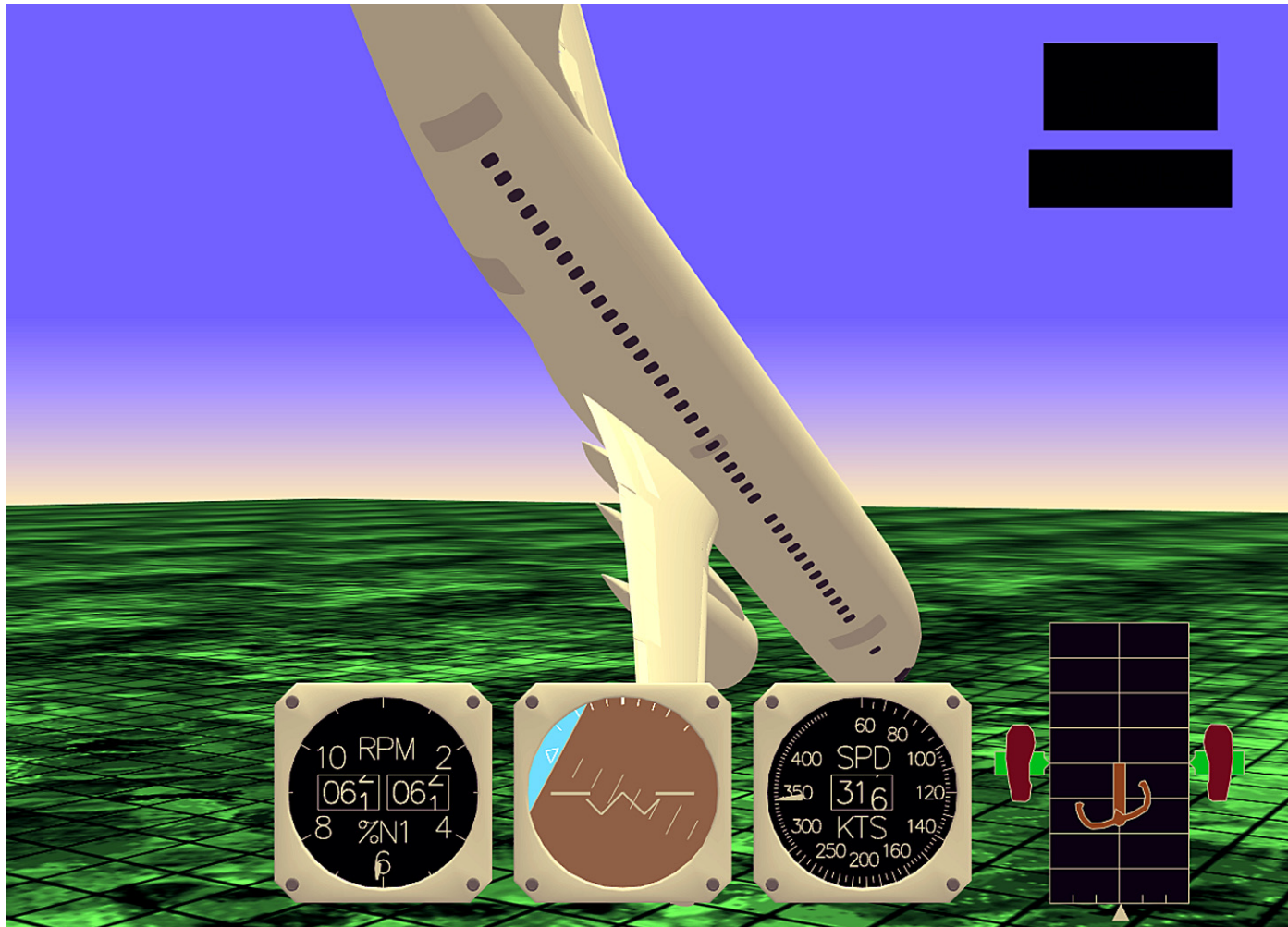

- Reduce the angle of attack, if necessary

Figure 3-B.79

## High-Bank-Angle Recovery Techniques

Situation: Bank angle greater than 45 deg; pitch attitude lower than 10 deg; airspeed increasing.

- Simultaneously reduce thrust and roll the shortest direction to wings level.

# High-Bank-Angle Recovery Techniques



Figure 3-B.80

## High-Bank-Angle Recovery Techniques

Situation: Bank angle greater than 45 deg; pitch attitude lower than 10 deg; airspeed increasing.

- Recover to level flight:
  - Apply noseup elevator.
  - Apply stabilizer trim, if necessary.
  - Adjust thrust and drag, as necessary.



# High-Bank-Angle Recovery Techniques



Figure 3-B.81

## Consolidated Summary of Airplane Recovery Techniques

Nose-high recovery:

- Recognize and confirm the situation.
- Disengage autopilot and autothrottle.
- Apply as much as full nosedown elevator.
- Use appropriate techniques:
  - Roll (adjust bank angle) to obtain a nosedown pitch rate.
  - Reduce thrust (underwing-mounted engines).
- Complete the recovery:
  - Approaching the horizon, roll to wings level.
  - Check airspeed, adjust thrust.
  - Establish pitch attitude.

# Summary of Airplane Recovery Techniques

## Nose-High Recovery

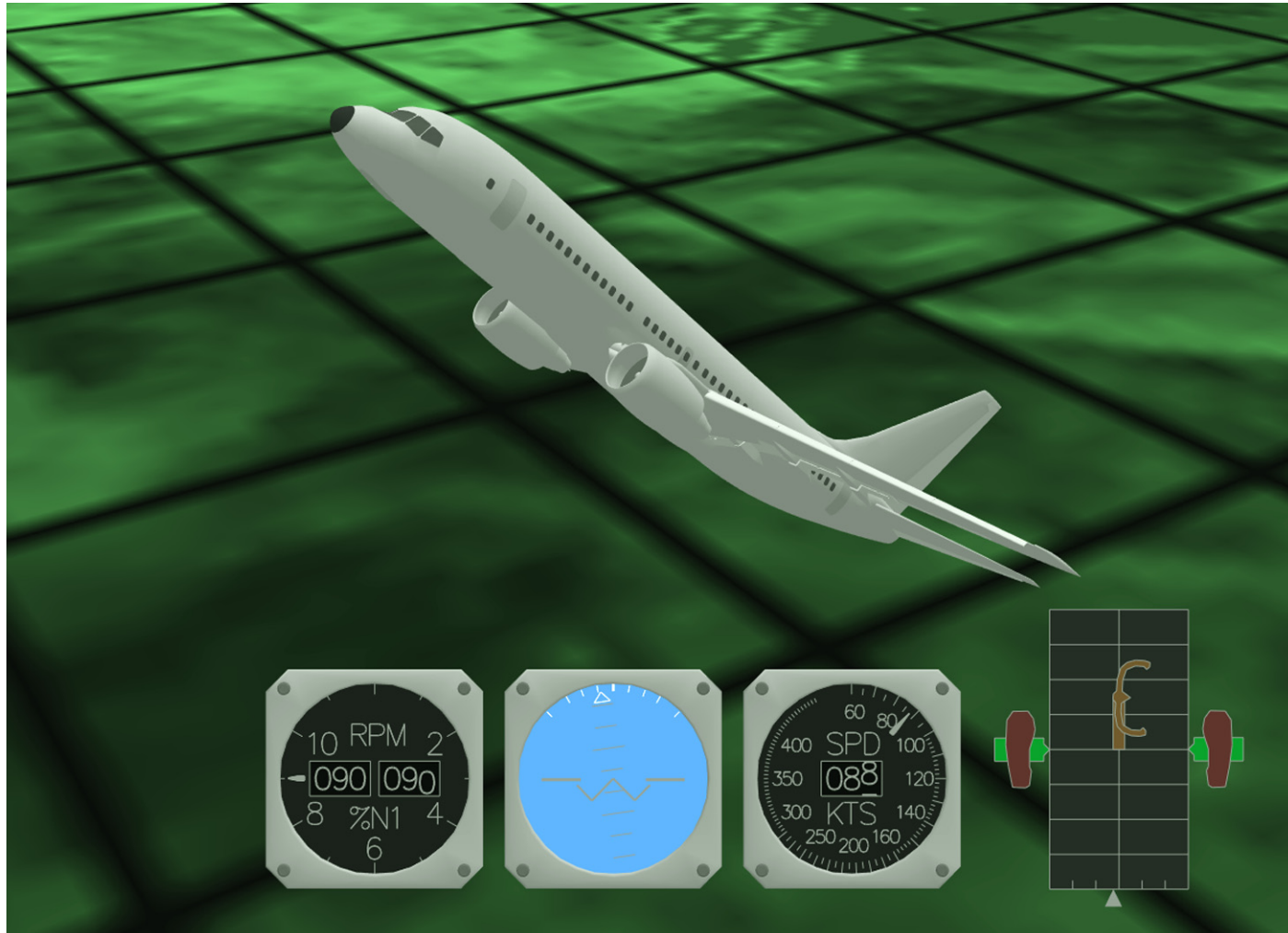

Figure 3-B.82

## Consolidated Summary of Airplane Recovery Techniques

Nose-high recovery:

- Recognize and confirm the situation.
- Disengage autopilot and autothrottle.
- Apply as much as full nosedown elevator.

# **Summary of Airplane Recovery Techniques**

## **Nose-High Recovery**

- **Recognize and confirm the situation**
- **Disengage autopilot and autothrottle**
- **Apply as much as full nosedown elevator**

## Consolidated Summary of Airplane Recovery Techniques

Nose-high recovery:

- Use appropriate techniques:
  - Roll (adjust bank angle) to obtain a nosedown pitch rate.
  - Reduce thrust (underwing-mounted engines).

# **Summary of Airplane Recovery Techniques**

## **Nose-High Recovery**

- **Use appropriate techniques:**
  - **Roll (adjust bank angle) to obtain a nosedown pitch rate**
  - **Reduce thrust (underwing-mounted engines)**

## Consolidated Summary of Airplane Recovery Techniques

Nose-high recovery:

- Complete the recovery:
  - Approaching the horizon, roll to wings level.
  - Check airspeed; adjust thrust.
  - Establish pitch attitude.



# **Summary of Airplane Recovery Techniques**

## **Nose-High Recovery**

- **Complete the recovery:**
  - **Approaching the horizon, roll to wings level**
  - **Check airspeed; adjust thrust**
  - **Establish pitch attitude**

## Consolidated Summary of Airplane Recovery Techniques

Nose-low recovery:

- Recognize and confirm the situation.
- Disengage autopilot and autothrottle.
- Recover from stall, if necessary.
- Roll in the shortest direction to wings level:
  - Bank angle to more than 90 deg; unload and roll.
- Recover to level flight:
  - Apply noseup elevator.
  - Apply stabilizer trim, if necessary.
  - Adjust thrust and drag, as necessary.

# Summary of Airplane Recovery Techniques

## Nose-Low Recovery

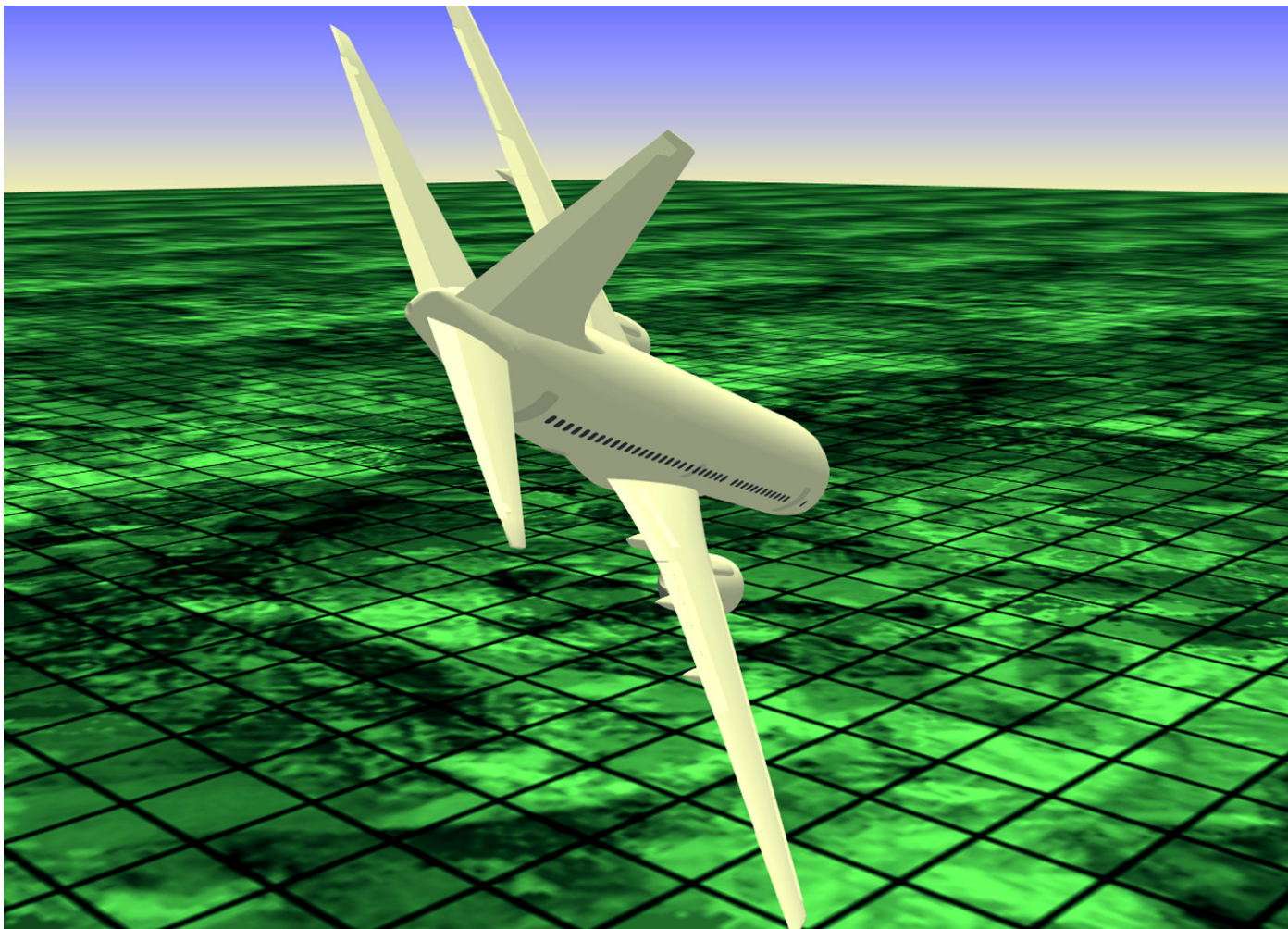

Figure 3-B.86

## Consolidated Summary of Airplane Recovery Techniques

Nose-low recovery:

- Recognize and confirm the situation.
- Disengage autopilot and autothrottle.
- Recover from stall, if necessary.

# **Summary of Airplane Recovery Techniques**

## **Nose-Low Recovery**

- **Recognize and confirm the situation**
- **Disengage autopilot and autothrottle**
- **Recover from stall, if necessary**

## Consolidated Summary of Airplane Recovery Techniques

Nose-low recovery:

- Roll in the shortest direction to wings level:
  - Bank angle to more than 90 deg; unload and roll.

# Summary of Airplane Recovery Techniques

## Nose-Low Recovery

- **Roll in the shortest direction to wings level:**
  - **Bank angle to more than 90 deg; unload and roll**

## Consolidated Summary of Airplane Recovery Techniques

Nose-low recovery:

- Recover to level flight.
  - Apply noseup elevator.
  - Apply stabilizer trim, if necessary.
  - Adjust thrust and drag, as necessary.



# **Summary of Airplane Recovery Techniques**

## **Nose-Low Recovery**

- **Recover to level flight**
  - **Apply noseup elevator**
  - **Apply stabilizer trim, if necessary**
  - **Adjust thrust and drag, as necessary**



---

## Video Script: Airplane Upset Recovery

# 3-C

This video consists of two parts. Part One provides information covering the causes of airplane upsets and the fundamentals of aerodynamics. Part Two presents several airplane upset scenarios and recovery techniques that may be used to return an airplane to its normal flight regime. The video was developed by an aviation industry team as part of the *Airplane Upset Recovery Training Aid*. The team envisions that both parts may be used for initial pilot training and Part Two may be used for recurring training. This script is provided to aid operators who choose to translate the video into other languages.



## PART 1

FADE in TEXT over the black screen.

TEXT: *The scenes that follow are based upon actual airplane upset incidents.*

1. FADE in. On a series of quick cuts, STOCK footage of a variety of airplane models/manufacturers at airports across the world. We see *a lot* of activity: jets taxiing, taking off, landing, etc.

**Fast-paced, percussive MUSIC runs up...**

2. CUT to 3D COMPUTER ANIMATION SEQUENCE #1.

We see an airplane in flight that suddenly rolls and pitches nose down.

**NARRATOR: A pilot initiates a missed approach. The airplane suddenly rolls and impacts the ground in a 17-degree, nosedown pitch attitude.**

AIRPLANE MAKE/MODEL: GENERIC

3. CUT back to STOCK. Continue with quick scenes of heavy jet transports at world airports. Again, a lot of activity.

**MUSIC up...**

4. CUT to 3D COMPUTER ANIMATION SEQUENCE #2.

We see an airplane in flight pitching up.

**NARRATOR: An airplane on approach experiences pitch excursions of greater than 70 degrees. The airplane does not recover.**

AIRPLANE MAKE/MODEL: GENERIC

5. CUT back to STOCK. Continue with activity at world airports, a variety of scenes.

**MUSIC up...**

6. CUT to 3D COMPUTER ANIMATION SEQUENCE #3.

We see an airplane executing a missed approach (go-around). It pitches nose up and then stalls.

AIRPLANE MAKE/MODEL: GENERIC

7. CUT back to STOCK. We see five or six more airport activity shots, then, CUT to

8. FREEZE-FRAME of GRAPHIC BACKGROUND. Bring in FREEZE-FRAMES from each of the preceding 3D accident animation sequences. In each FREEZE-FRAME, we see the airplane in an unusual attitude.

9. DISSOLVE to our narrator, in an airport environment (an office/area that overlooks the ramp area where we can see general airport activity. The office/area itself is not identifiable with any particular airline.) The narrator turns from the window to address the CAMERA. He is a subject matter expert, but we do not associate him with any manufacturer, airline, or government agency.

10. DELETED.

11. DISSOLVE to PHOTOS from loss-of-control accidents.

**NARRATOR: An airplane is on an automatic ILS approach, but an error has been made with the autoflight system. The airplane enters a severe nose-high pitch attitude, stalls, and does not recover.**

**MUSIC up...**

**VOICE-OVER: Three different accidents...three different causes... but one common thread: at some point in each case, the airplane was upset and entered an “unusual attitude” – that is, the plane unintentionally exceeded the parameters that you, the pilot, normally experience in day-to-day operations.**

**“Every day, around the world, tens of thousands of airplanes take flight. As you well know, an overwhelming majority of those flights proceed without incident.”**

**MUSIC bump (somber...)**

**VOICE-OVER: Airplane upsets are not a common occurrence. However, there have been many loss- of-control incidents in multi-engine, turbojet airplanes. And, since the beginning of the jet age,**

12. CUT back to animation (use footage from 3D ANIMATED SEQUENCE #2). We see an airplane nose high and then stalling/no recovery.

there have been a significant number of commercial jet transport accidents attributed to control problems.

**Music out.**

**VOICE-OVER: As you'll see, causes for airplane upsets are varied, and in some cases, difficult to agree upon. But one thing everyone agrees with is that once your airplane is upset and enters an unusual attitude, you may have little time to react. The actions you take are critical to recovery.**

13. DISSOLVE back to the narrator.

**"With this in mind, airlines, pilot associations, airplane manufacturers and government aviation and regulatory agencies feel it is appropriate that you receive Airplane Upset Recovery Training."**

14. DISSOLVE to GRAPHIC BACKGROUND. On-screen text corresponds with narration.

**VOICE-OVER: This video will define airplane upset...will look at causes...and will review aerodynamic principles that form a basis for recovery.**

ON-SCREEN TEXT:

- Define Airplane Upset
- Examine Causes
- Review Aerodynamics

15. DISSOLVE back to the narrator.

**Music begins under...**

**"There's no doubt, you never want to be in a situation where your airplane has rolled or pitched out of control. But if you do find yourself in such a situation, the information that follows can play a vital part in a successful recovery."**

16. DISSOLVE back to GRAPHIC BACKGROUND. Title appears as on-screen text, followed by a second line underneath for subtitle.

ON-SCREEN TEXT:

- Airplane Upset Recovery:
- Overview and Aerodynamics

17. DISSOLVE back to our narrator.

18. DISSOLVE to 3D ANIMATION SEQUENCE #4.

We see an airplane in a compass outline.

As per sequences 1–3, this is a generic airplane—a specific model, but no airline markings or colors.

The plane moves from “normal flight” to demonstrate a particular “upset” attribute. Between attributes, it returns momentarily to “normal” flight.

19. DISSOLVE back to the narrator.

**MUSIC comes up and holds throughout title sequence, then fades back under...**

**“An airplane is defined as upset if it unintentionally exceeds the parameters normally experienced in line operations or training. Specific values may vary among airplane models, but the following conditions are generally agreed upon:”**

**VOICE-OVER: Unintentional pitch attitude greater than 25 degrees, nose up...**

**Unintentional pitch attitude greater than 10 degrees, nose down...**

**Unintentional bank angle greater than 45 degrees...**

**Or even within these parameters, but flying at airspeeds inappropriate for the conditions.**

**“The causes of airplane upset are varied, but these can also be broadly categorized: upsets that are environmentally induced... those caused by airplane components... those caused by human factors... or those induced by a combination of any of these.”**  
**MUSIC bump....**



20. DISSOLVE to air-to-air footage: scenes of clouds. On-screen text appears over scene on lower third of screen. It fades out as narration begins.
- CUT to pilots in a preflight briefing, reviewing weather information.
- ON-SCREEN TEXT:
- Environmental
21. DISSOLVE to air-to-air footage. We see an airplane moving through changing weather conditions.
22. CUT to air-to-air footage: unique or unusual cloud patterns/formations.
23. CUT to flight deck footage. We see weather instrumentation in cockpit.
24. CUT to STOCK from wake vortex testing. We see an airplane following another airplane with wingtip smoke streamers, illustrating wake vortex turbulence.
25. CUT to 2D ART—GRAPHIC #1: Illustration of windshear principles.

**VOICE-OVER:** Interpreting and responding to rapidly changing environmental conditions is a constant way of life for the working pilot. These conditions can also lead to airplane upset, although not all of them have a direct effect on the airplane itself.

**VOICE-OVER:** For example, a rapid environmental change may dictate a quick transition from VMC to IMC. During this transition, it's often easy to get distracted. Research shows that an upset is more likely to develop when the flight crew is distracted.

**VOICE-OVER:** Environmental conditions can also cause visual illusions, such as false vertical and horizontal cues. During such illusions, instruments can be misinterpreted, and again, the flight crew can be distracted.

**VOICE-OVER:** The biggest danger from environmental conditions, however, are those that directly affect the airplane flight path, such as the various types of turbulence a pilot might encounter.

**VOICE-OVER:** Industry study has validated that wake vortex turbulence can contribute to an airplane upset.

**VOICE-OVER:** Windshear has also been extensively studied and is a known cause of upset.

26. CUT to 2D ART—GRAPHIC #2:  
Illustration of mountain wave principles.
- VOICE-OVER: Mountain wave—severe turbulence advancing up one side of a mountain and down the other—is another environmental factor that can affect the airplane flight path...**
27. CUT to flight deck footage. We see pilot and copilot from behind (not identifiable with any airline). CUT close on instruments to highlight rapid excursion—the effect of turbulence.
- VOICE-OVER: As is clear air turbulence, often marked by rapid changes in pressure...temperature fluctuations...and dramatic changes in wind direction and velocity.**
28. CUT to footage of thunderclouds, then severe winter weather at an airport.
- VOICE-OVER: Other environmentally induced factors that can contribute to, or cause, an airplane upset include thunderstorms...and weather conditions that result in ice build-up on the airplane.**
29. CUT to flight deck footage. We see/hear the pilot asking for a route around severe weather.
- The best solution to environmental hazards is to avoid them when possible.**
30. DISSOLVE to flight deck scene: CLOSE-UP on the instrument panel. On-screen text appears over the lower third of the screen. It fades out as the narration begins.
- MUSIC bump...**
- Then cut to scenes of pilots at work.
- VOICE-OVER: Today's airplanes are remarkably reliable, and malfunction of components or equipment that can lead to an upset are rare. Because of this high level of reliability, when these problems do occur, they can surprise the flight crew.**
- ON-SCREEN TEXT:
- Component or Equipment
31. CUT to simulator: pilots reacting to autopilot failure.
- VOICE-OVER: Airplane component problems such as an instrument failure or an autopilot failure fall under this category. Again, the result can be direct, such as an autopilot failure resulting in a pitch moment...or there can be an indirect effect, if the flight crew has been significantly distracted by**

32. CUT to simulator. Pilots reacting to trailing edge flap assembly problem.

the failure of a particular component.

**VOICE-OVER: Other causes include flight control anomalies and system failures that lead to unusual control input requirements—as might be experienced with an engine failure, failure of the yaw damper, the spoilers, the flaps or slats, the primary flight controls, or as a result of structural problems.**

33. DISSOLVE to flight deck footage. We see pilot and copilot from behind. Not identifiable with any airline. On-screen text appears over the lower third of the screen. It fades out as the narration begins.

**MUSIC bump...**

**Human factors must also be taken into account when examining possible causes.**

ON-SCREEN TEXT:

- Human Factors

34. CUT to flight deck footage. We see close-ups of pilot and copilot at work, from a variety of angles.

**VOICE-OVER: Cross-check and instrument interpretation is an example. Misinterpretation of instruments or a slow cross-check may lead to an upset.**

35. CUT to simulator. Pilots reacting to a vertical mode malfunction.

**VOICE-OVER: An upset can result from unexpected airplane response to power adjustments, automated functions, or control inputs...inappropriate use of automation...or by pilots applying opposing inputs simultaneously.**

36. CUT to simulator. Pilots reviewing map as airplane slows to stalling speed.
37. CUT to close-up on an attitude indicator at an obviously severe angle, with the horizon superimposed over.
38. CUT to airplane in flight. HALF-DISSOLVE pilot passing out over control column; then newspaper headline from hijacking situation.
39. DISSOLVE back to the narrator. When he completes the narration, he exits the frame.
40. DISSOLVE to a “classroom” environment. We can tell by the material on the walls, etc., that this is a flight crew training environment. On-screen text appears over the lower third of the screen. It fades out as the narrator enters the frame.

ON-SCREEN TEXT:

- Aerodynamics

**VOICE-OVER: As previously mentioned, inattention or distraction in the flight deck can lead to an upset. This includes any type of distraction that causes the flight crew to disregard control of the airplane, even momentarily.**

**VOICE-OVER: Spatial disorientation, the inability to correctly orient one’s self with respect to the Earth’s surface, has been a significant factor in many airplane upsets.**

**VOICE-OVER: Other rare, but possible human factors include pilot incapacitation due to a medical problem, or, even rarer, a hijacking situation.**

**“A combination of any of these factors can also lead to upset. It’s important to remember that we’re trying to look at all possible causes here, no matter how remote the possibility. The fact is, it’s sometimes this very remoteness that allows an upset situation to develop.”**

**MUSIC bump...**

**“Now that we’ve taken a look at possible causes, let’s take a few moments to review some key aerodynamic principles. These are things you learned at the beginning of your flying career. You now react instinctively in the flight deck and rarely need to think about aerodynamic theory. However, in an airplane upset situation, these principles form the basis for recovery.”**

41. CUT to shots of the Chief Test Pilots for Boeing, Airbus, and Boeing Douglas Products Division touring together at the National Air and Space Museum.

42. DISSOLVE to the Airbus Chief Test Pilot. He addresses the camera. KEY: Capt. William Wainwright, Airbus

43. DISSOLVE to 3D COMPUTER ANIMATION SEQUENCE #5.

We see an airplane in flight. When Capt. Wainwright says “energy,” we highlight the engines. When he says “flight path,” an arrow or velocity vector draws on that illustrates the plane’s flight path out ahead of it. When he says “maneuver,” the plane banks to the right.

44. DISSOLVE to an airplane in flight.

45. CUT to scenes of an airplane in flight. We see the engines, as well as the wing.

46. CUT to flight deck footage. We see pilot operating flight controls.

CUT to an airplane in flight.

**VOICE-OVER: We’ve asked the Chief Test Pilots for Boeing and Airbus to assist us in this discussion. These are pilots who’ve taken their airplanes to the extremes.**

**“When discussing large-airplane aerodynamics, three words often enter the conversation:”**

**PILOT VOICE-OVER: Energy--the capacity to do work... Flight path—the actual direction and velocity an airplane follows... and Maneuver—a controlled variation of the flight path.**

**PILOT VOICE-OVER: In an airplane, the ultimate goal of using energy is to maneuver the airplane to control the flight path.**

**PILOT VOICE-OVER: The energy created by the thrust of the engines and the lift generated by the wings is controlled by the thrust levers and flight controls to overcome gravity and aerodynamic drag.**

**PILOT VOICE-OVER: In other words, flight controls give you the ability to balance the forces acting on the airplane in order to maneuver—to change the flight path of the airplane. The direction of the lift produced by the wings is independent of the direction of gravity.**

47. CUT back to Capt. Wainwright.

CUT to 3D COMPUTER ANIMATION SEQUENCE #6. We see an airplane in flight with instrumentation package superimposed. We see speed slowing as altitude increases.

48. CUT close on the airplane model and pointer stick as Capt. Wainwright demonstrates the angle-of-attack principle.

CUT DISSOLVE to 3D COMPUTER ANIMATION SEQUENCE #6A. We see an airplane in flight with the angle of attack increasing to the point of stall in both nose-high and nose-low situations.

49. DISSOLVE to Boeing Chief Test Pilot.  
KEY: Capt. John Cashman, Boeing.

50. DISSOLVE to 3D COMPUTER ANIMATION SEQUENCE #7.

We see an airplane in a pitch and yaw diagram angle. As detailed by Capt. Cashman, we see the airplane pitch back and forth. When he details the elevator, we see that component highlighted.

51. CUT to air-to-air, airplanes in flight

**“Two other important principles: energy management...and angle of attack. An airplane in flight has two types of energy: kinetic, or airspeed, and potential, or altitude. You exchange speed for altitude...and altitude for speed.”**

**“The angle at which the wing meets the relative wind is called the “angle of attack.” Angle of attack does not equate to pitch angle. Changing the angle of attack either increases or decreases the amount of lift generated. But beyond the stall, the angle of attack must be reduced to restore lift.”**

**“Now, let’s look at the elements of stability...”**

**PILOT VOICE-OVER: Movement around the lateral axis of an airplane is called “pitch” and is usually controlled by the elevator. At any specific combination of airplane configuration, weight, center of gravity, and speed, there will be one elevator position at which all of these forces are balanced.**

**PILOT VOICE-OVER: In flight, the two elements most easily changed are speed and elevator position; as the speed changes, the elevator position must be adjusted to balance the aerodynamic forces. For example, as the speed increases, the wing creates more lift.**

52. CUT to close air-to-air shot. We see an airplane slightly pitching up and down.
- PILOT VOICE-OVER: If the airplane is at a balanced, “in-trim” position in flight, it will generally seek to return to the trimmed position if upset by external forces or momentary pilot input. This is called “positive longitudinal static stability.”**
53. CUT back to Capt. Cashman. He speaks to camera, mocks pulling and pushing column.
- “We’ve all experienced this and are familiar with the requirements to apply pull forces when an airplane is slowed and push forces when an airplane speeds up.”**
54. CUT to 3D COMPUTER ANIMATION SEQUENCE #8.
- We see extension of speedbrakes and resulting noseup-pitch moment.
- 1/14—change in narration.
- PILOT VOICE-OVER: Changes in airplane configuration will also affect pitching moment. For example, extending wing-mounted speedbrakes generally produces a noseup pitching moment.**
55. CUT to a scene that reflects an electronic flight control system airplane.
- PILOT VOICE-OVER: Airplanes that have electronic flight control systems, commonly referred to as “fly-by-wire,” may automatically compensate for these changes in configuration.**
56. CUT to airplane in flight. We see it pitch up as thrust increases.
- PILOT VOICE-OVER: Thrust affects pitch as well. With underwing engines, reducing thrust creates a nosedown pitching moment; increasing thrust creates a noseup pitching moment.**
57. CUT to examples of airplanes with tail-mounted engines.
- PILOT VOICE-OVER: Airplanes with fuselage- or tail-mounted engines, or those designed with electronic flight controls, produce different effects. Whatever type of plane you are flying, you need to know how the airplane will respond.**

58. DISSOLVE to 3D COMPUTER ANIMATION SEQUENCE # 9. We see the tail end of an airplane, with elevator and stabilizer moving.

59. CUT back to 3D COMPUTER ANIMATION SEQUENCE # 9A. We see a close-up of the stabilizer and elevator showing a “jackknifed” condition.

60. CUT to Boeing Douglas Products Division Chief Test Pilot.  
KEY: Capt. Tom Melody, Boeing Douglas Products Division.

61. DISSOLVE to 3D COMPUTER ANIMATION SEQUENCE #10.

We see an airplane in a pitch and yaw diagram. As detailed by Capt. Melody, we see the airplane yaw. When he details the rudder, we see that component highlighted.

62. CUT back to Capt. Melody. The tail section of an airplane fills the area behind him. He speaks to the camera.

**PILOT VOICE-OVER: The combination of elevator and stabilizer position also affects pitch. In normal maneuvering, the pilot displaces the elevator to achieve a change in pitch. The stabilizer is then trimmed by driving it to a new position to balance the forces.**

**PILOT VOICE-OVER: This new stabilizer position is faired with the elevator. If the stabilizer and elevator are not faired, one cancels out the other. This condition limits the airplane’s ability to overcome other pitching moments from configuration changes or thrust.**

**“Now, let’s continue this discussion by taking a look at yaw and roll.”**

**MUSIC bump...**

**PILOT VOICE-OVER: Motion about the vertical axis is called “yaw” and is controlled by the rudder. Movement of the rudder creates a force and a resulting rotation about the vertical axis.**

**“The vertical stabilizer and the rudder are sized to meet two objectives: to control asymmetric thrust from an engine failure at the most demanding flight condition... and to generate sufficient sideslip for cross-wind landings.”**



63. CUT close on the tail as the rudder moves.

**PILOT VOICE-OVER:** To achieve these objectives at takeoff and landing speeds, the vertical stabilizer and rudder must be capable of generating powerful yawing moments and large sideslip angles.

64. DISSOLVE to 3D COMPUTER ANIMATION SEQUENCE #11.

We see an airplane in a pitch and yaw diagram. As detailed by Capt. Melody, we see the airplane roll back and forth. When he details the ailerons and spoilers, we see those components highlighted.

CUT to airplane in flight, rolling.

**MUSIC bump...**

**PILOT VOICE-OVER:** Motion about the longitudinal axis is called roll. Control inputs cause the ailerons—and then spoilers—to control the airplane's roll rate. The aileron and spoiler movement changes the local angle of attack of the wing—changing the amount of lift—which causes rotation about the longitudinal axis.

65. CUT to animation: we see ailerons highlighted. Cut to interior of simulator as needed.

**PILOT VOICE-OVER:** During an upset, there may be unusually large amounts of aileron input required to recover the airplane. If necessary, this can be assisted by coordinated input of rudder in the direction of the desired roll.

66. CUT back to animation: we see airplane at high angle of attack.

**PILOT VOICE-OVER:** However, when a large-transport, swept-wing airplane is at a high angle of attack, pilots must be careful when using the rudder for assisting lateral control. Excessive rudder can cause excessive sideslip, which could lead to departure from controlled flight.

## 67. CUT to 2D ART—GRAPHIC #3:

View of full airplane from slightly above and to the side. We see airflow passing over the wing and around the rudder. As the angle of attack increases, we see airflow separate over the wing, but remain aerodynamically effective around the rudder.

## 68. CUT to 3D COMPUTER ANIMATION SEQUENCE #12.

We see demonstration of crossover speed.

We see airplane begin yaw roll.

Indicate unloading of control column.

## 69. CUT to airspeed indicator. We see high airspeed.

## 70. CUT to flight deck scene—simulate vibration.

1/14—Change in text.

CUT to 3D COMPUTER ANIMATION SEQUENCE. (Variation of sequence #8A. Speedbrake extension as seen in scene 54—but this one is at high speed and the pitch moment is more pronounced.)

**PILOT VOICE-OVER:** As angle of attack increases, aileron and spoiler effectiveness decreases because the airflow begins to separate over the wing. However, the rudder airflow is not separated; it remains aerodynamically effective.

**PILOT VOICE-OVER:** In some aircraft configurations, there is a certain crossover speed at which full aileron and spoiler deflection is necessary to counter the roll due to full rudder deflection and the resulting sideslip. Below this crossover speed, the rolling moment created by ailerons and spoilers is gradually unable to counter the rolling moment induced by the sideslip generated by full rudder deflection. The airplane must be unloaded to reduce angle of attack, and the airspeed must be increased, to maintain lateral control.

**PILOT VOICE-OVER:** In contrast, very high speeds in excess of  $V_{MO}$  and  $M_{MO}$  cause control surfaces to be blown down, rendering them less effective.

**PILOT VOICE-OVER:** The main concern at high speed in excess of  $V_{MO}$  and  $M_{MO}$  comes from vibrations and high airloads that may lead to structural damage. Other effects often include reduced effectiveness or even reversal of control response. Any pitching moment due to speedbrake extension or retraction is more pronounced at high speed,

71. CUT to simulator. Pilots reacting to shock-wave vibration.

Then, CUT to 2D ART—GRAPHIC #4.

Illustration of shock-wave principles.

and pitching effects as a result of thrust changes are less pronounced.

**PILOT VOICE-OVER: High-speed buffet is caused by shock-wave instability. As the airplane exceeds its cruise speed, the shock wave that runs along the wing upper surface becomes strong enough to cause the beginning of a local separation or stall. This causes the flow over the wing to fluctuate, leading to rapid changes in drag and the position of the center of pressure. The ensuing buffet results in a loss of aerodynamic efficiency of the wing, which will impact the high-speed dive recovery.**

72. CUT to simulator. Pilots reacting to buffet.

**PILOT VOICE-OVER: The buffet can be disconcerting and will normally not be symmetrical on each wing—resulting in a rocking motion during a pull-up. The pilot should relax the pull force if high-speed buffet is encountered.**

73. CUT to Boeing Capt. John Cashman in simulator.

**“Altitude and Mach also affect the performance of the control surfaces...”**

74. CUT to close-up on altitude indicator. We see high altitude number.

**PILOT VOICE-OVER: The higher the altitude, and Mach, the more sensitive the airplane is to control surface movements, making the recovery more difficult.**

75. Then CUT to 3D COMPUTER ANIMATION SEQUENCE #13.

We see an airplane entering a yaw, rolling motion.

Airplane yaws back to normal flight.

76. CUT to 3D COMPUTER ANIMATION SEQUENCE #14. We see demonstration of an airplane in  $V_{MCA}$  condition.

77. DISSOLVE to flight test footage of full stall testing (A340 and 777).

78. DISSOLVE to 3D COMPUTER ANIMATION SEQUENCE # 15. We see an airplane rolling in response to rudder input.

**PILOT VOICE-OVER:** Asymmetric thrust affects roll. When there is asymmetric thrust, sideslip is created, and thus, roll. This is normally countered with rudder and lateral control. Obviously then, reducing an asymmetric thrust condition will also reduce the sideslip associated with it.

**PILOT VOICE-OVER:** The definition of  $V_{MCA}$  is the minimum flight speed at which the airplane is controllable with a maximum of 5-degrees bank when the critical engine suddenly becomes inoperative with the remaining engine at takeoff thrust. Below this speed there is insufficient directional control.

**PILOT VOICE-OVER:** As the air-speed decreases, the ability to maneuver the airplane also decreases. During a full or deep stall, the flight controls become less effective because of the high angle of attack.

**PILOT VOICE-OVER:** However, the rudder remains effective at lower speeds. This can be good or bad—At speeds above stall, the rudder can assist the airplane's ability to roll. However, at slower speeds, there will be a delay after application of the rudder before roll response becomes apparent to you. Also, the amount of rudder used and the rate at which it is applied is critical. The bad part is that at speeds approaching the stall speed, or speeds below the stall speed, use of rudder applied too quickly or held too long may

- 78.5 result in loss of lateral and directional control and cause structural damage.
79. Scene of rudder (tail).  
At any speed, large aggressive control reversals can lead to loads that can exceed structural design limits.
80. DISSOLVE back to Airbus Capt. Bill Wainwright.  
“Another consideration for longitudinal control is ‘g’ load. That is, the amount of load factor that is aligned with the vertical axis of the airplane.”
81. DISSOLVE to plane in a level turn.  
**PILOT VOICE-OVER:** In a level turn or pull-up, the wing has to create more lift and the pilot feels more g load. The increased g load will also increase the stall speed.
82. CUT to 3D ANIMATED SEQUENCE #16.  
Airplane actions correspond to narration.  
**PILOT VOICE-OVER:** Generally, the elevator and stabilizer have sufficient control authority to drive the wing past its stall angle of attack, even at high speed, which can adversely affect pitch and roll control.
83. CONTINUE with ANIMATED SEQUENCE #16.  
Highlight stick shaker with visual and audible.  
**PILOT VOICE-OVER:** This means that the wing can be stalled. In this case, regardless of the pitch attitude, a pilot cannot command a specific bank angle or flight path, even at high airspeeds. The airplane has entered into an accelerated stall. The wing loading must be reduced to recover from this stall and regain pitch and roll control.

84. CUT to flight deck scenes of fly-by-wire airplanes.

CUT to A320 at high angle of attack.

85. DISSOLVE to Boeing Douglas Products Division Capt. Tom Melody.

Then DISSOLVE to flight test footage from Boeing, Airbus, and McDonnell Douglas. We see airplanes at unusual attitudes or extreme test conditions.

86. DISSOLVE back to our narrator.

CREDIT RUN OF PROGRAM PARTICIPANTS.

FADE out.

**PILOT VOICE-OVER: Airplanes with electronic flight control systems may provide protection against entering into many upset situations. These systems also assist the airplane to return to normal flight, if necessary. However, when fly-by-wire airplanes operate in the degraded mode, flight control inputs and the responses are similar to non-fly-by-wire airplanes.**

**MUSIC bump...**

**“The aerodynamic principles we’ve reviewed are applied to airplane design.”**

**PILOT VOICE-OVER: During flight testing, all airplane manufacturers exceed these parameters to help prove the safety of the airplanes that you eventually fly. A working knowledge of these principles is vital to a successful recovery from an upset situation.**

**MUSIC bump...**

**“In this video, we’ve defined what an airplane upset is...we’ve looked at causes...and we’ve reviewed the aerodynamics associated with recovery. We’ve laid a foundation. To build upon this foundation, follow-on training should review specific recovery techniques.”**

**MUSIC comes up...**

## PART 2

87. FADE in on a series of accident photos/footage.

DISSOLVE to animation sequence: airplane in upset condition.

88. DISSOLVE to our narrator. He is in a simulator environment. He addresses the camera.

89. DISSOLVE to 3D COMPUTER ANIMATION SEQUENCE #4

(As detailed in scene 18.) We see an airplane demonstrating upset attributes.

90. DISSOLVE to upset animation.

**MUSIC runs under...**

**VOICE-OVER: Different accidents...different causes...but all of these accidents do have one thing in common...At some time during the flight, an airplane upset occurred. And there's one other critical thing they have in common: the flight crews did not recover.**

**“An airplane is defined as upset if it unintentionally exceeds the parameters normally experienced in line operations or training. Specific values vary among airplane models, but the following conditions are generally agreed upon:”**

**VOICE-OVER: Unintentional pitch attitude greater than 25 degrees, nose up...**

**Unintentional pitch attitude greater than 10 degrees, nose down...**

**Unintentional bank angle greater than 45 degrees...**

**Or even within these parameters, but flying at airspeeds inappropriate for the conditions.**

**MUSIC fades under...**

**VOICE-OVER: Airplane upsets do happen...but they are rare. Because of this rarity, a flight crew that finds itself in an upset situation can quickly be overwhelmed.**

91. DISSOLVE to scenes from Video #1: A weather scene...a component malfunction scene...the pilots distracted scene...then animation of an upset situation. On-screen text appears over background.

ON-SCREEN TEXT:

- Recognize and Confirm the Situation
- Disengage the Autopilot and Autothrottle
- Required Flight Control Authority
- Maneuver to Normal Bank/Pitch

92. CUT to animation: airplane in an obvious upset condition.

Then CUT to simulator: pilot reacting to upset condition.

93. CUT to new angle on the narrator.

**VOICE-OVER: Causes of upsets vary—they may be caused by environmental factors...by component or equipment malfunction...by human factors...or by a combination of any of these. But no matter the cause, the foundation for recovery is the same...**

**You must—recognize and confirm the situation...**

**disengage the autopilot and autothrottle...**

**use whatever authority is required of the flight controls...**

**and you must maneuver the airplane to return to normal bank and pitch...**

**VOICE-OVER: Once you've entered an upset condition, you probably won't be able to rely on outside visual references—in many cases you won't be able to locate the horizon.**

**You must plan on interpreting your instruments...**

**And if you are unsure if an instrument is working, such as your attitude indicator, you must confirm your situation through multiple sources. In fact, that's one of the reasons why redundancy of critical instrumentation is built into an airplane.**

**"This video will examine specific recovery techniques that you can use once your airplane has been upset. We've asked three pilots to help us with this discussion—three pilots who have actually been in some of the situations we'll be looking at."**



94. DISSOLVE to scenes of Capt. John Cashman (Boeing), Capt. Tom Melody (Boeing Douglas Products Division) and Capt. William Wainwright (Airbus), touring at the National Air and Space Museum.

**VOICE-OVER: The chief test pilots for Boeing and Airbus have a great deal of expertise when it comes to airplanes that fly outside the normal regime. During flight testing, they regularly push their airplanes beyond normal flight parameters.**

95. CUT back to narrator.

**“For the purposes of this training, it doesn’t matter how or why the airplane entered an upset situation, or what caused it...what matters most is that you understand that your reaction time is limited—in short, if you find yourself in an upset situation, you must act, and you must act quickly and correctly. You must also guard against letting the recovery of one airplane upset lead into a different upset situation.”**

96. DISSOLVE to our three test pilots—a group shot, at the National Air and Space Museum. Capt. William (Bill) Wainwright begins. After his first sentence, ZOOM in on Bill.

**Capt. Wainwright: “An Upset Recovery Team comprised of representatives from airlines, pilot associations, airplane manufacturers, and government aviation and regulatory agencies developed the techniques presented here. These techniques are not necessarily procedural. Use of both primary and secondary flight controls to effect the recovery from an unusual attitude are discussed.”**

KEY: Capt. William Wainwright, Airbus

CUT to Boeing Capt. John Cashman.

**Capt. Cashman: “Your air carrier must address procedural application within your own fleet structure. The Upset Recovery Team strongly recommends that your procedures for initial recovery emphasize using primary flight controls (aileron, elevator, and rudder). However, the application of secondary flight controls (stab**

KEY: Capt. John Cashman, Boeing

97. CUT to Boeing Douglas Products Division Capt. Tom Melody.

KEY: Capt. Tom Melody, Boeing Douglas Products Division.

CUT back to Capt. Wainwright.

97A. CUT back to Capt. Cashman.

trim, thrust vector effects, and speedbrakes) may be considered incrementally to supplement primary flight control inputs after the recovery has been initiated.”

**Capt. Melody:** “One more thing—the recovery techniques we’ll discuss assume that the airplane is not stalled. If it is stalled, it is necessary to first recover from the stalled condition before initiating these techniques. At this point, we feel it is important to discuss stall recovery. As a pilot, you hear and use a lot of different terminology when discussing stalls: ‘stall warning’, ‘stick shaker’, deep stalls’ and ‘approach to stalls.’ These are all used in daily conversation.”

**Capt. Wainwright:** “As we said, In some upset situations, you must first recover from a stall before applying any other recovery actions. Now what do we mean by that? By stall, we mean an angle of attack beyond the stalling angle. A stall is characterized by any, or a combination, of the following:”

**Capt. Cashman:** “Buffeting, which could be heavy...the lack of pitch authority...the lack of roll control...inability to arrest descent rate. These characteristics are usually accompanied by a continuous stall warning. A stall must not be confused with the stall warning that occurs before the stall and warns of an approaching stall. You have been trained to recover from an approach to stall, which is not the same as a recovery from a stall. An approach to stall is a con-

CUT back to Capt. Melody.

98. DISSOLVE to scenes of airplanes in flight: Airbus air-to-air and Boeing air-to-air.

99. DISSOLVE to GRAPHIC BACKGROUND. Title appears as on-screen text, followed by a second line for Part Two title.

ON-SCREEN TEXT:

- Airplane Upset Recovery:
- Recovery Techniques

trolled flight maneuver. However, a full stall is an out-of-control condition, but it is recoverable.”

**Capt. Melody:** “To recover from the stall, angle of attack must be reduced below the stalling angle. You must apply nosedown pitch control and maintain it until you have recovered from the stall. Under certain conditions, on airplanes with underwing-mounted engines, you may have to reduce thrust in order to prevent the angle of attack from continuing to increase. Once unstalled, continue with the other recovery actions and reapply thrust as needed.”

**VOICE-OVER:** Airplanes that are designed with electronic flight control systems, commonly referred to as “fly-by-wire” airplanes, have safety features that should preclude the airplane from entering into an upset and assist the pilot in recovery if it becomes necessary. However, when fly-by-wire airplanes are in the degraded flight control mode, the recovery techniques and aerodynamic principles we will discuss are appropriate.

**MUSIC** comes up and holds throughout the title sequence, then fades back under...

100. DISSOLVE to FREEZE-FRAME from 3D COMPUTER ANIMATION SEQUENCE #17.

On-screen text appears over the lower third of the screen, then fades out as narration begins.

ON-SCREEN TEXT:

- Nose High, Wings Level

Animation (sequence 17A) transitions from FREEZE-FRAME to FULL MOTION. We see the airplane pitching up. Instrumentation dissolves on.

101. CUT to Capt. John Cashman in flight deck of a Boeing airplane simulator. He turns from the pilot's seat to address the camera.

102. CUT back to animation (sequence 17A, with instrumentation).

CUT to Capt. Cashman, in simulator, applying sustained column force and trim.

103. CUT back to Capt. Cashman. He speaks to the camera.

**MUSIC bump...**

**VOICE-OVER:** Imagine a wings-level situation where the airplane pitch attitude is unintentionally more than 25 degrees, nose high—and increasing. In this case, the airspeed is decreasing rapidly. As the airspeed decreases, the ability to maneuver the airplane also decreases. Recognize and confirm the situation.

**“Start by disengaging the autopilot and the autothrottle.”**

**PILOT VOICE-OVER:** Next, apply nosedown elevator to achieve a nosedown pitch rate. This may require as much as full nosedown input. If a sustained column force is required to obtain desired response, you may consider trimming off some of the control force. However, it may be difficult to know how much trim should be used. Therefore, care must be taken to avoid using too much trim. Do not fly the airplane using pitch trim, and stop trimming nose down as the required elevator force lessens.

**“If at this point you cannot immediately get the pitch rate under control, there are several additional techniques which may be tried. The use of these techniques depends on the circumstances of**

104. CUT back to 3D ANIMATION SEQUENCE #18.

We see plane starting to bank.

Replay this sequence as needed. Highlight deflection of ailerons and spoilers.

105. CUT back to Capt. Cashman. He addresses the camera.

106. DISSOLVE to 3D ANIMATION SEQUENCE #19.

Highlight engine thrust.

107. DISSOLVE back to 3D ANIMATION SEQUENCE #20.

Highlight rudder input.

the situation and the airplane control characteristics.”

**PILOT VOICE-OVER:** You may also control the pitch by rolling the airplane to a bank angle which starts the nose down—normally not to exceed approximately 60 degrees. Maintaining continuous nosedown elevator pressure will keep the wing angle of attack as low as possible, making the normal roll controls as effective as possible. With airspeed as low as stick shaker onset, normal roll controls—up to full deflection of the ailerons and spoilers—can be used. The rolling maneuver changes the pitch rate into a turning maneuver, allowing the pitch to decrease.

“In most situations, the steps we’ve just outlined should be enough to recover. Other techniques may also be employed to achieve a nosedown pitch rate.”

**PILOT VOICE-OVER:** If altitude permits, flight tests have shown that an effective method to get a nosedown pitch rate is to reduce the power on underwing-mounted engines. This will reduce the upward pitch moment.

**PILOT VOICE-OVER:** If the control provided by the ailerons and spoilers is ineffective, rudder input may be required to induce a rolling maneuver for recovery.

108. CUT back to Capt. Cashman. Cover with continuation of animation as needed.

109. CUT back to 3D ANIMATION SEQUENCE #20A.

We see plane returning to normal flight.

110. DISSOLVE to a scene of Capt. Cashman in the simulator, from behind, wide. KEY on-screen text over this scene.

1/15/98—text change.

ON-SCREEN TEXT:

Nose High, Wings Level:

- Recognize and Confirm the Situation

110A. CUT to a close-up of EICAS display indication disconnection of autothrottle and autopilot. KEY on-screen text over this scene.

ON-SCREEN TEXT:

- Disengage Autopilot and Autothrottle

110B. CUT to Capt. Cashman applying nosedown elevator. KEY on-screen text over this scene.

ON-SCREEN TEXT:

- Apply as Much as Full Nosedown Elevator

**“Only a small amount of rudder is needed—too much rudder applied too quickly—or held too long—may result in loss of lateral and directional control. Because of the low-energy condition, use caution when applying rudder.”**

**PILOT VOICE-OVER: To complete the recovery, roll to wings level as the nose approaches the horizon. Recover to a slightly nose-low attitude, check airspeed, and adjust thrust and pitch as necessary.**

**MUSIC comes up.**

**MUSIC continues...**

**MUSIC continues...**

110C. CUT back to animation. KEY on-screen text over this scene.

ON-SCREEN TEXT:

- Use Appropriate Techniques:
  - Roll to obtain nosedown pitch rate
  - Reduce thrust (underwing mounted engines)

110D. CUT to a scene from animation of airplane recovering. KEY on-screen text over this scene.

ON-SCREEN TEXT:

- Complete the Recovery:
  - Approaching horizon, roll to wings level
  - Check airspeed, adjust thrust
  - Establish pitch attitude

110E. DISSOLVE to GRAPHIC BACKGROUND. On-screen text appears over background, highlighting 2nd review of recovery steps.

\_\_\_\_ ON-SCREEN TEXT:

\_\_\_\_ Nose High, Wings Level:

- Recognize and Confirm the Situation
- Disengage Autopilot/Autothrottle
- Apply as Much as Full Nosedown Elevator
- Use Appropriate Techniques:
  - Roll to obtain nosedown pitch rate
  - Reduce thrust (underwing-mounted engines)
- Complete the Recovery
  - Approaching horizon, roll to wings level
  - Check airspeed, adjust thrust
  - Establish pitch attitude

**MUSIC continues...**

**MUSIC continues...**

**MUSIC continues....**

111. DISSOLVE to FREEZE-FRAME from 3D COMPUTER ANIMATION SEQUENCE #21.

1/15/98—text change.

On-screen text appears over the lower third of the screen, then fades out as narration begins.

ON-SCREEN TEXT:

- Nose Low, Wings Level

Airbus test pilot begins voice-over.

Animation transitions from FREEZE-FRAME to FULL MOTION. We see the airplane pitching down.

112. CUT to Airbus Capt. William Wainwright in the flight deck of an Airbus airplane. He turns to address the camera.

He applies nosedown elevator.

112A. CUT back to COMPUTER ANIMATION SEQUENCE #21A. We see the airplane returning to normal flight.

113. CUT to 3D ANIMATION SEQUENCE #22.

**MUSIC bump...**

**VOICE-OVER:** Now imagine an upset situation where the airplane pitch attitude is unintentionally more than 10 degrees, nose low. Recognize and confirm the situation.

**“In a nose-low, low-speed situation, remember, the aircraft may be stalled at a relatively low pitch, and it is necessary to recover from the stall first. This may require nosedown elevator, which may not be intuitive.”**

**PILOT VOICE-OVER:** Once recovered from the stall, apply thrust. The nose must be returned to the desired pitch, avoiding a secondary stall, as indicated by stall warning or buffet. Respect the airplane limitations of g forces and airspeed.

**PILOT VOICE-OVER:** In a nose-low, high-speed situation, apply noseup elevator. Then, it may be necessary to cautiously apply stabilizer trim, to assist obtaining the desired noseup pitch rate. Reduce thrust and, if required, extend speedbrakes.



114. CUT back to Capt. Wainwright in the flight deck. He addresses the camera.

**“Complete the recovery by establishing a pitch, thrust, and configuration that corresponds to the desired airspeed.”**

115. CUT close on the column. Pull back to reveal Capt. Wainwright.

**“A question naturally arises: How hard do I pull? Here are some considerations. Obviously, you must avoid impacting the terrain. But also avoid entering into an accelerated stall. And respect the aircraft’s limitations of g forces and airspeed.”**

116. DISSOLVE to a scene of Capt. Wainwright in the Airbus flight deck. On-screen text appears over background, highlighting review of recovery steps.

**MUSIC up...**

**ON-SCREEN TEXT:**

**Nose Low, Wings Level:**

- Recognize and Confirm the Situation

116A. CUT to Capt. Wainwright disengaging autopilot and autothrottles. KEY on-screen text over this scene.

**Music continues...**

**ON-SCREEN TEXT:**

- Disengage Autopilot and Autothrottle

116B. CUT to a scene from the animation. KEY on-screen text over this scene.

**Music continues...**

**ON-SCREEN TEXT:**

- Recover From Stall if Necessary

116C. Continue with scene from the animation (new angle). KEY on-screen text over this scene.

ON-SCREEN TEXT:

- Recover to Level Flight
  - Apply noseup elevator
  - Apply stabilizer trim if necessary
  - Adjust thrust and drag as necessary

116D. DISSOLVE to GRAPHIC BACKGROUND. On-screen text appears over background, highlighting 2nd review of recovery steps.

ON-SCREEN TEXT:

Nose Low, Wings Level:  
(High and Low Speeds)

- Recognize and Confirm the Situation
- Disengage Autopilot/Autothrottle
- Recover From the Stall if Necessary
- Recover to Level Flight:
  - Apply noseup elevator
  - Apply stabilizer trim if necessary
  - Adjust thrust and drag as necessary

117. DISSOLVE to FREEZE-FRAME from 3D COMPUTER ANIMATION SEQUENCE #23.

On-screen text appears over the lower third of the screen, then fades out as narration begins.

ON-SCREEN TEXT:

- High Bank Angles

Animation transitions from FREEZE-FRAME to FULL MO-

**Music continues...**

**MUSIC bump...**

**VOICE-OVER: We've defined a high bank angle for upset as more than 45 degrees; however, it is possible to experience bank angles greater than 90 degrees. In high-bank-angle situations, the primary objective is to roll in the shortest direction to near wings level, but if the airplane is stalled, you must first recover from the stall. Recognize and confirm the situation.**

TION. We see the airplane in high bank angle attitude (60 degrees).

118. CUT to Boeing Douglas Products Division Capt. Tom Melody in the flight deck of a McDonnell Douglas airplane. He addresses the camera.

119. CUT back to 3D ANIMATION SEQUENCE #24.

We see the airplane recover.

CUT to a scene of Capt. Melody in the simulator, unloading the airplane.

120. CUT back to Capt. Melody.

CUT back to 3D ANIMATION SEQUENCE #25.

121. CUT to a close-up: disconnection of autopilot/autothrottle.

CUT back to 3D ANIMATION SEQUENCE #25B.

We see the airplane roll to recovery.

**“At high bank angles, you may be in a nose-high attitude, or a nose-low attitude. Let’s look at a nose-high situation first.”**

**PILOT VOICE-OVER: A nose-high, high-angle-of-bank attitude requires deliberate flight control inputs. A large bank angle is helpful in reducing excessively high-pitch attitudes. Unload and adjust the bank angle to achieve a nosedown pitch rate while keeping energy management and airplane roll-rate in mind. To complete the recovery, roll to wings level as the nose approaches the horizon. Recover to a slightly nose-low attitude, check airspeed, and adjust thrust and pitch as necessary.**

**“A nose-low, high-angle-of-bank attitude requires prompt action because altitude is rapidly being exchanged for airspeed. Even if the airplane is at an altitude where ground impact is not an immediate concern, airspeed can rapidly increase beyond airplane design limits. Simultaneous application of roll and adjustment of thrust may be necessary.”**

**PILOT VOICE-OVER: Again, disengage the autopilot and autothrottle. In this situation, it may be necessary to unload the airplane by decreasing backpressure or even pushing to obtain forward elevator pressure.**

122. CUT back to Captain Melody.

Continue animation.

123. CUT to 3D ANIMATION SEQUENCE #26.

CUT close on the rudder as it moves.

124. Continue animation. We see the airplane returning to normal flight.

125. DISSOLVE to on-camera narrator.

CUT to a series of wrap-up scenes—scenes we have seen during the video.

**“Use full aileron and spoiler input, if necessary, to smoothly establish a recovery roll rate toward the nearest horizon.”**

**PILOT VOICE-OVER: It is important to not increase g force or use noseup elevator or stabilizer until approaching wings level.**

**PILOT VOICE-OVER: If full lateral control application is not satisfactory, you may need to apply rudder in the direction of the desired roll.**

**PILOT VOICE-OVER: As the wings approach level, use the procedures we discussed earlier for a nose-low situation. Adjust thrust and drag devices as required.**

**MUSIC bump...**

**“As you’ve seen, there are specific techniques you can use if your airplane becomes upset. No matter the type of upset—nose-high, wings level...nose-low, wings level...high angle of bank—you must take control of the situation, and you must react quickly and correctly.”**

**VOICE-OVER: Let’s review the nose-high and nose-low recoveries one more time, incorporating bank angles.**

126. DISSOLVE to GRAPHIC BACKGROUND. On-screen text appears over background, highlighting review of recovery steps.

ON-SCREEN TEXT:

Nose High:

- Recognize and Confirm the Situation
- Disengage Autopilot/Autothrottle
- Apply as Much as Full Nosedown Elevator
- Use Appropriate Techniques:
  - Roll (adjust bank angle) to obtain a nosedown pitch rate
  - Reduce thrust (underwing-mounted engines)
- Complete the Recovery:
  - Approaching the horizon, roll to wings level
  - Check airspeed/adjust thrust
  - Establish pitch attitude

127. DISSOLVE to GRAPHIC BACKGROUND. On-screen text appears over background, highlighting review of recovery steps.

ON-SCREEN TEXT:

Nose Low:

- Recognize and Confirm the Situation
- Disengage Autopilot/Autothrottle
- Recover From Stall, if Necessary
- Roll in the Shortest Direction to Wings Level
  - Bank angle more than 90 degrees: unload and roll
- Recover to Level Flight:
  - Apply noseup elevator
  - Apply stabilizer trim, if necessary
  - Adjust thrust and drag as necessary

**MUSIC up...**

**MUSIC up...**

128. DISSOLVE to a series of wrap-up scenes: scenes we have seen throughout the parts of the video.

129. CREDIT RUN OF PROGRAM PARTICIPANTS.

FADE out.

**VOICE-OVER: Remember, the sequence of application of these techniques will vary, depending upon the situation encountered. Thorough review of the causes of airplane upsets...and the recommended actions you should take, will help prepare you to act quickly and decisively should an upset occur.**

**MUSIC up...**



# Flight Simulator Information

## 3-D

### General Information

The ability of the simulators in existence today to adequately replicate the maneuvers being proposed for airplane upset recovery training is an important consideration. Concerns raised about simulators during the creation of the *Airplane Upset Recovery Training Aid* include the adequacy of the hardware, the equations of motion, and the aerodynamic modeling to provide realistic cues to the flight crew during training at unusual attitudes.

It is possible that some simulators in existence today may have flight instruments, visual systems or other hardware that will not replicate the full six-degree-of-freedom movement of the airplane that may be required during unusual attitude training. It is important that the capabilities of each simulator be evaluated before attempting airplane upset training and that simulator hardware and software be confirmed as compatible with the training proposed.

Properly implemented equations of motion in modern simulators are generally valid through the full six-degree-of-freedom range of pitch, roll, and yaw angles. However, it is possible that some existing simulators may have equations of motion that have unacceptable singularities at 90, 180, 270, or 360 deg of roll or pitch angle. Each simulator to be used for airplane upset training must be confirmed to use equations of motion and math models (and associated data tables) that are valid for the full range of maneuvers required. This confirmation may require coordination with the airplane and simulator manufacturer.

Operators must also understand that simulators cannot fully replicate all flight characteristics. For example, motion systems cannot replicate sustained linear and rotational accelerations. This is true of pitch, roll, and yaw accelerations, and longitudinal and side accelerations, as well as normal load factor, “g’s.” This means that a pilot cannot rely on all sensory feedback that would be available in an actual airplane. However, a properly programmed simulator should provide accurate control force feedback and the motion system should provide airframe buffet consistent with the aerodynamic

characteristics of the airplane which could result from control input during certain recovery situations.

The importance of providing feedback to a pilot when control inputs would have exceeded airframe, physiological, or simulator model limits must be recognized and addressed. Some simulator operators have effectively used a simulator’s “crash” mode to indicate limits have been exceeded. Others have chosen to turn the visual system red when given parameters have been exceeded. Simulator operators should work closely with training departments in selecting the most productive feedback method when selected parameters are exceeded.

The simulation typically is updated and validated by the airplane manufacturer using flight data acquired during the flight test program. Before a simulator is approved for any crew training, it must be evaluated and qualified by a national regulatory authority. This process includes a quantitative comparison of simulation results to actual flight data for certain test conditions such as those specified in the *ICAO Manual of Criteria for the Qualification of Flight Simulators*. These flight conditions represent airplane operation within the normal operating envelope.

The simulation may be extended to represent regions outside the typical operating envelope using wind tunnel data or other predictive methods. However, flight data are not typically available for conditions where flight testing would be very hazardous. From an aerodynamic standpoint, the regimes of flight that are usually not fully validated with flight data are the stall region and the region of high angle of attack with high sideslip angle where there may be separated airflow over the wing or empennage surfaces. While numerous approaches to stall or stalls are flown on each model (available test data are normally matched on the simulator), the flight controls are not fully exercised during an approach to stall or during a full stall, because of safety concerns. Also, roll and yaw rates and sideslip angle are carefully controlled during stall maneuvers to be near zero; therefore, validation of derivatives involving these terms in the stall region is not possible. Training maneuvers in this regime of



flight must be carefully tailored to ensure that the combination of angle of attack and sideslip angle reached during the maneuver does not exceed the range of validated data or analytical/extrapolated data supported by the airplane manufacturer.

Values of pitch, roll, and heading angles, however, do not directly affect the aerodynamic characteristics of the airplane or the validity of simulator training as long as angle of attack and sideslip angles do not exceed values supported by the airplane manufacturer. For example, the aerodynamic characteristics of the upset experienced during a 360-deg roll maneuver will be correctly replicated if the maneuver is conducted without exceeding the valid range of angle of attack and sideslip.

### Simulator Alpha-Beta Data Plots

The aerodynamic model for each simulation may be divided into regions of various “confidence levels,” depending on the degree of flight validation or source of predictive methods if supported by the airplane manufacturer, correctly implemented by the simulator manufacturer and accurately supported and maintained on an individual simulator. These confidence levels may be classified into three general areas:

1. High: Validated by flight test data for a variety of tests and flight conditions.
2. Medium: Based on reliable predictive methods.
3. Low: Extrapolated.

The flaps up data represent the maximums achieved at low speeds flaps up and do not imply that these values have been achieved at or near cruise speeds. For flaps down, the maximums were generally achieved at landing flaps, but are considered valid for the flaps down speed envelope.

**A300/A310 Flaps Up Alpha/Beta Envelope**

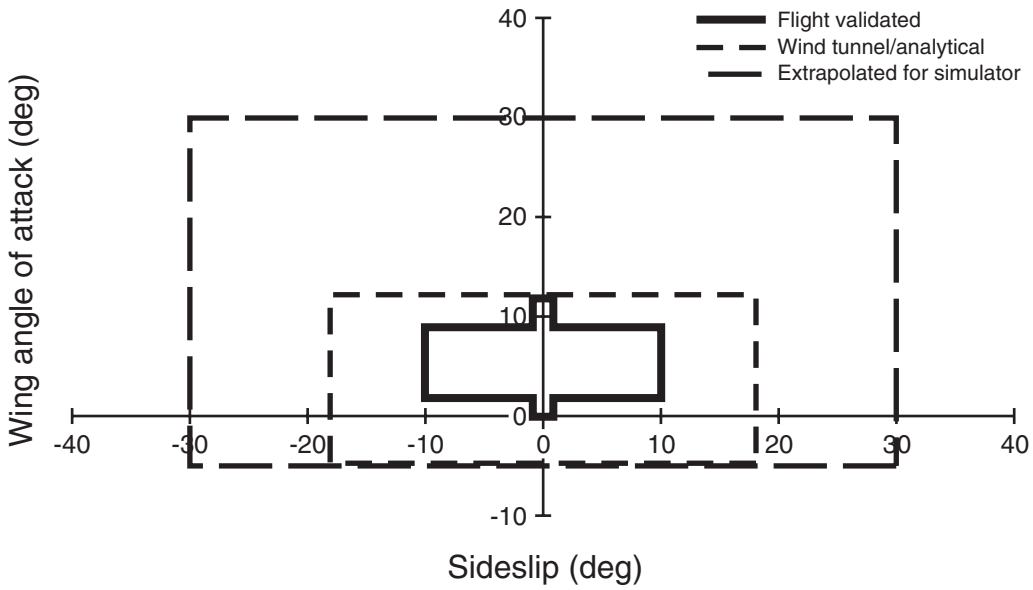

**A300/A310 Alpha/Beta Envelope**

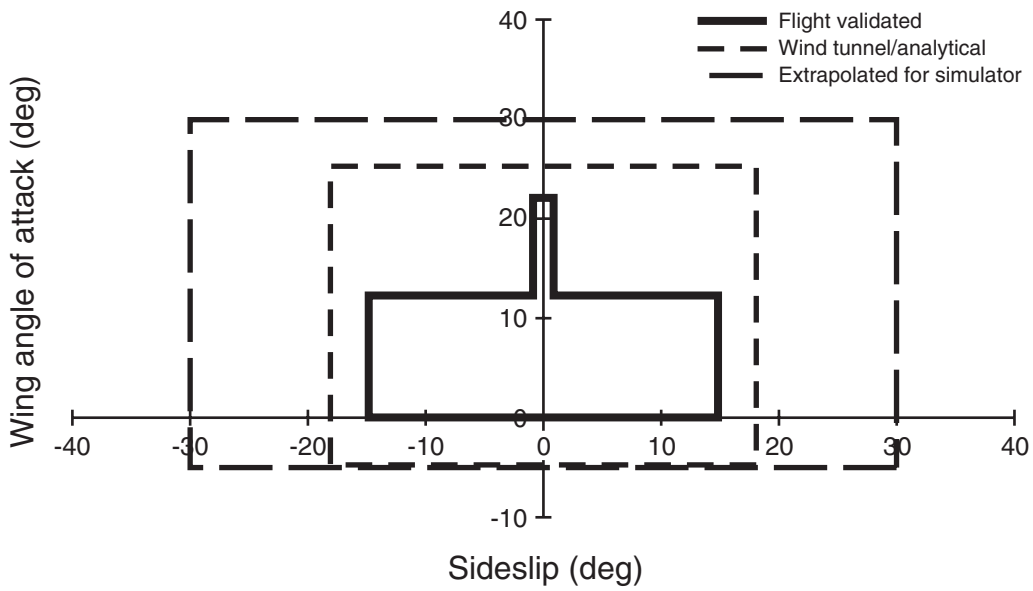

727 Alpha/Beta Envelope

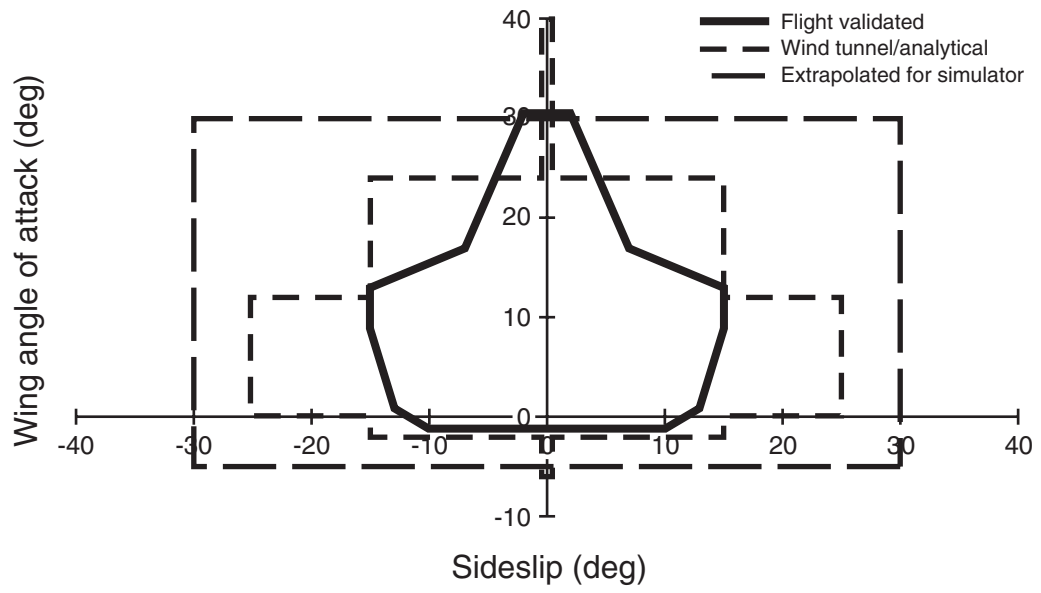

**737 Flaps Up Alpha/Beta Envelope**

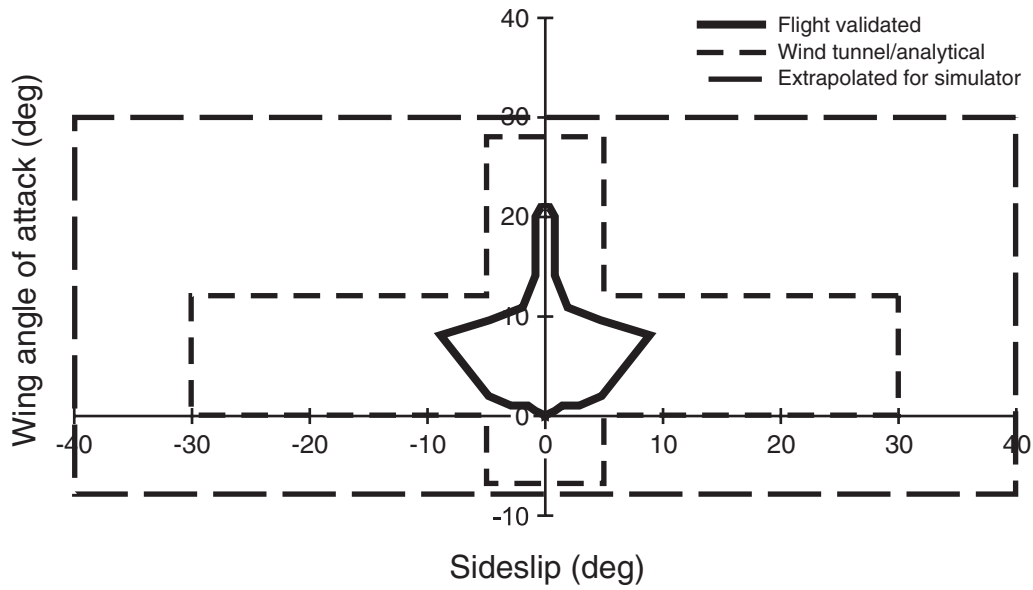

**737 Alpha/Beta Envelope**

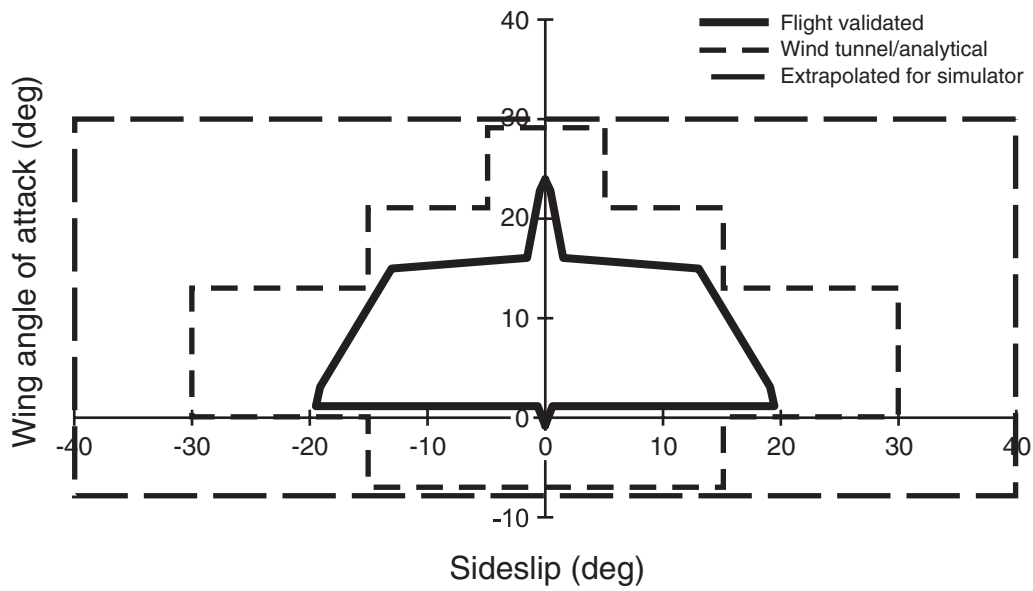

**747 Flaps Up Alpha/Beta Envelope**

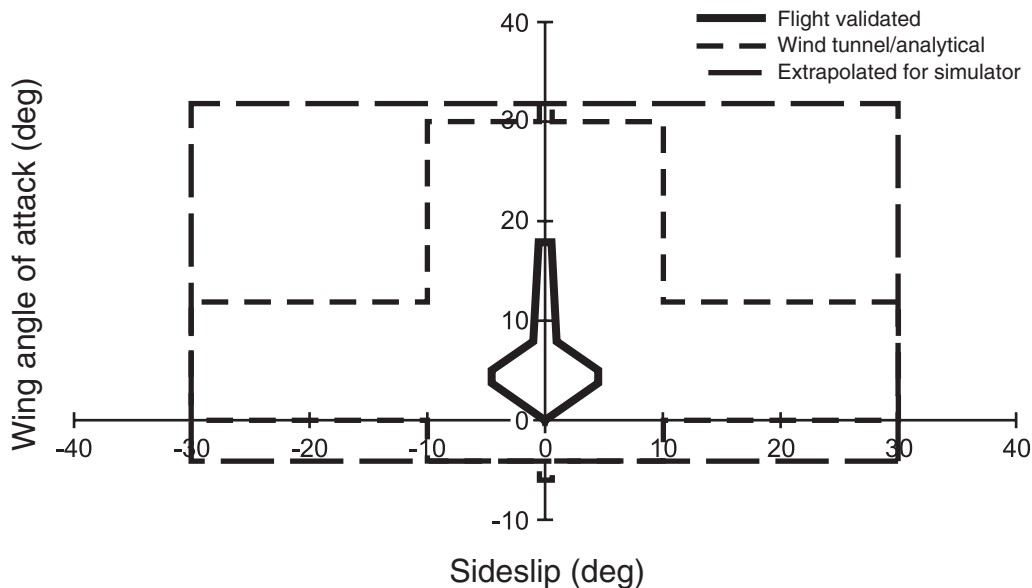

**747 Alpha/Beta Envelope**

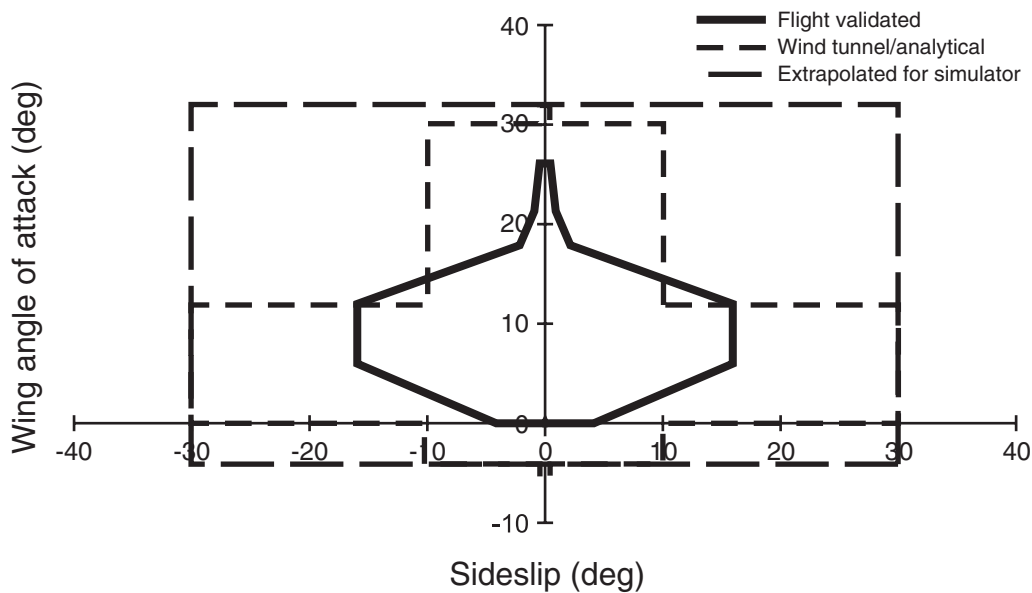

**757 Flaps Up Alpha/Beta Envelope**

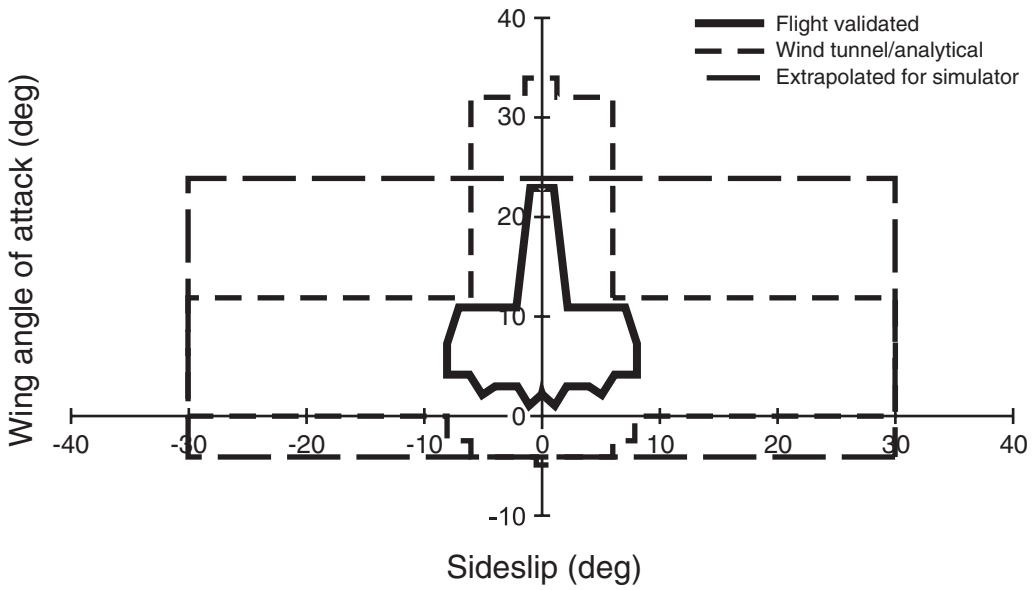

**757 Alpha/Beta Envelope**

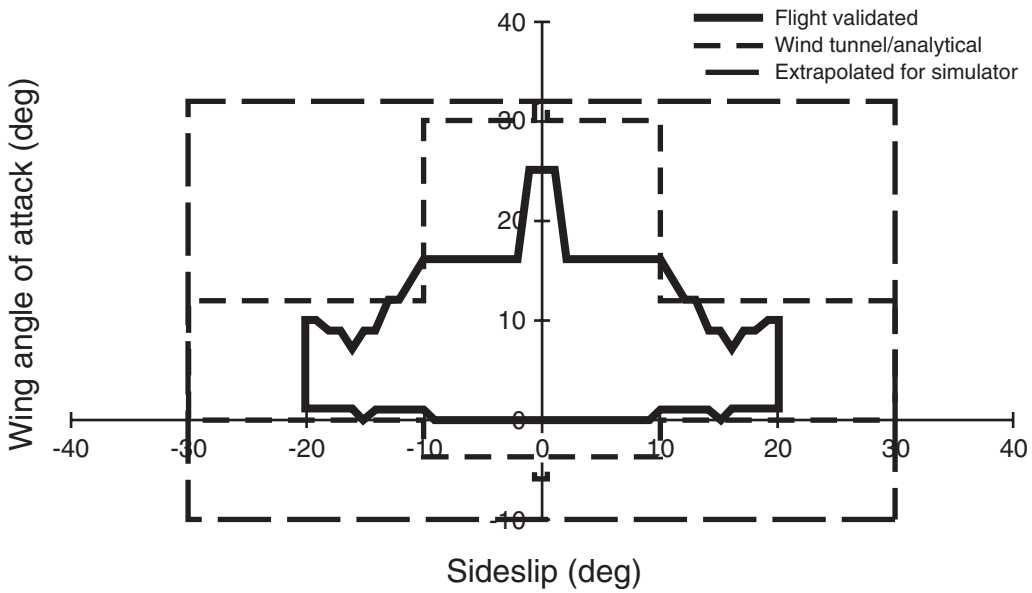

**767 Flaps Up Alpha/Beta Envelope**

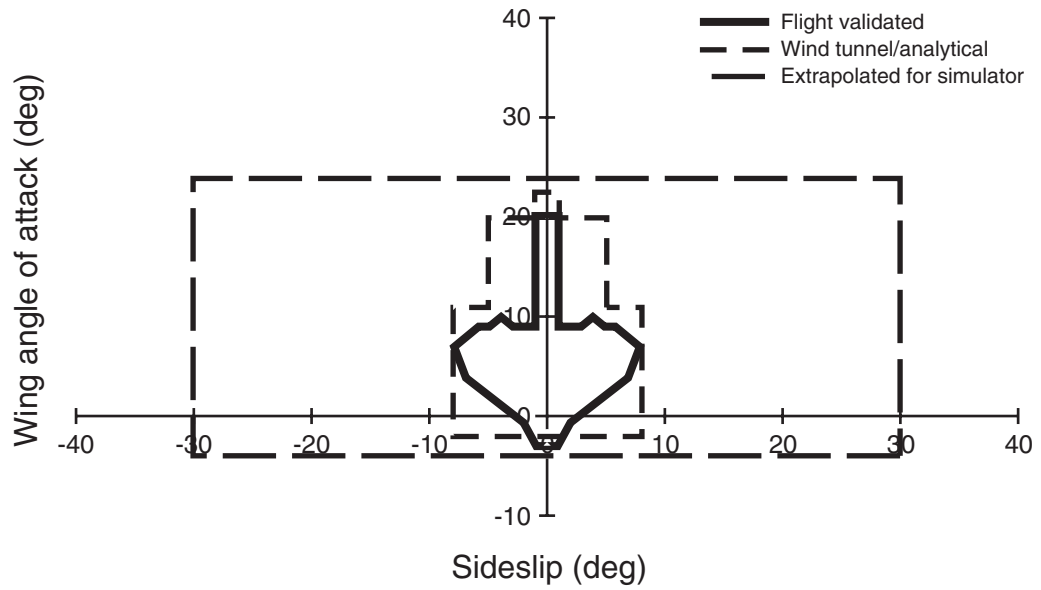

**767 Alpha/Beta Envelope**

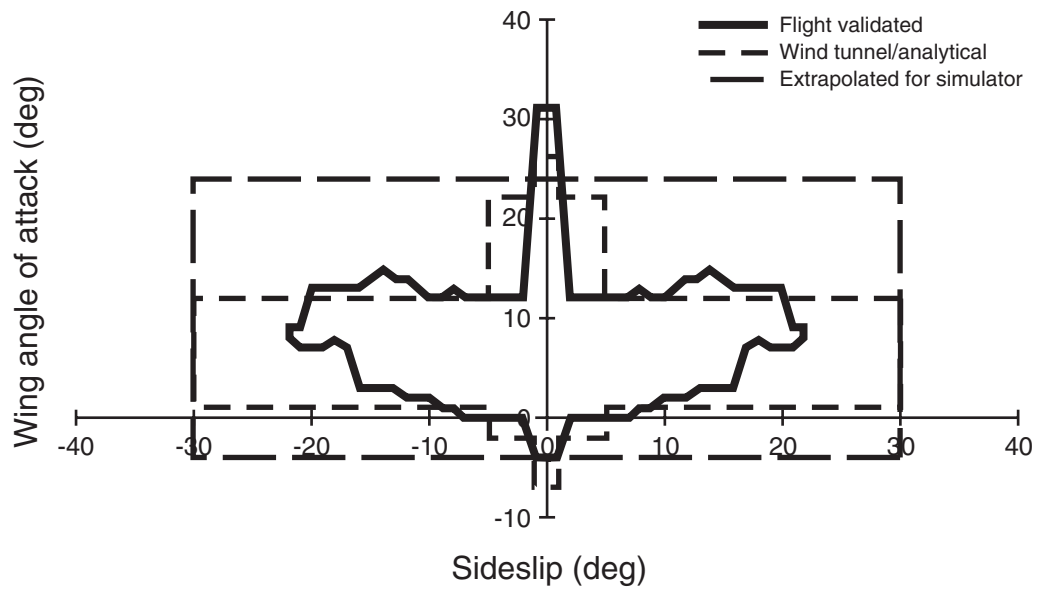

**777 Flaps Up Alpha/Beta Envelope**

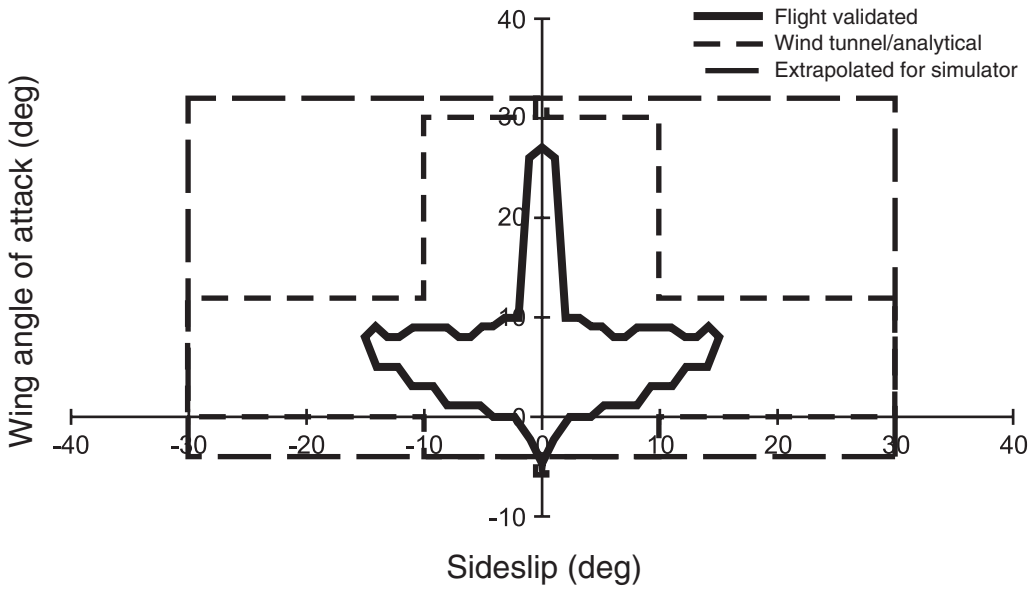

**777 Alpha/Beta Envelope**

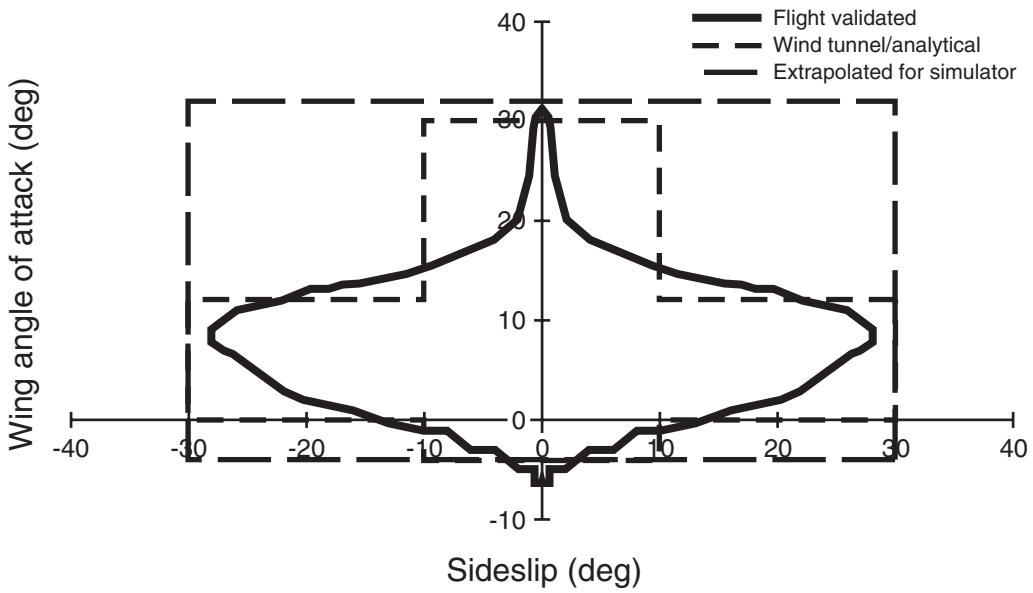



**MD-90 Flaps Up Alpha/Beta Envelope**

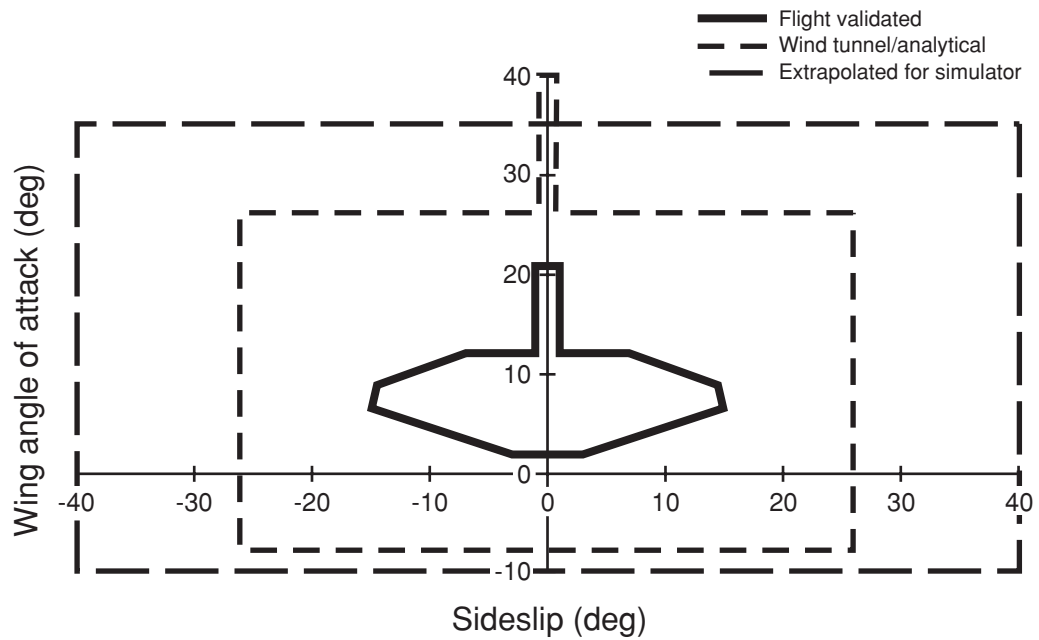

**MD-90 Alpha/Beta Envelope Flaps Deflected**

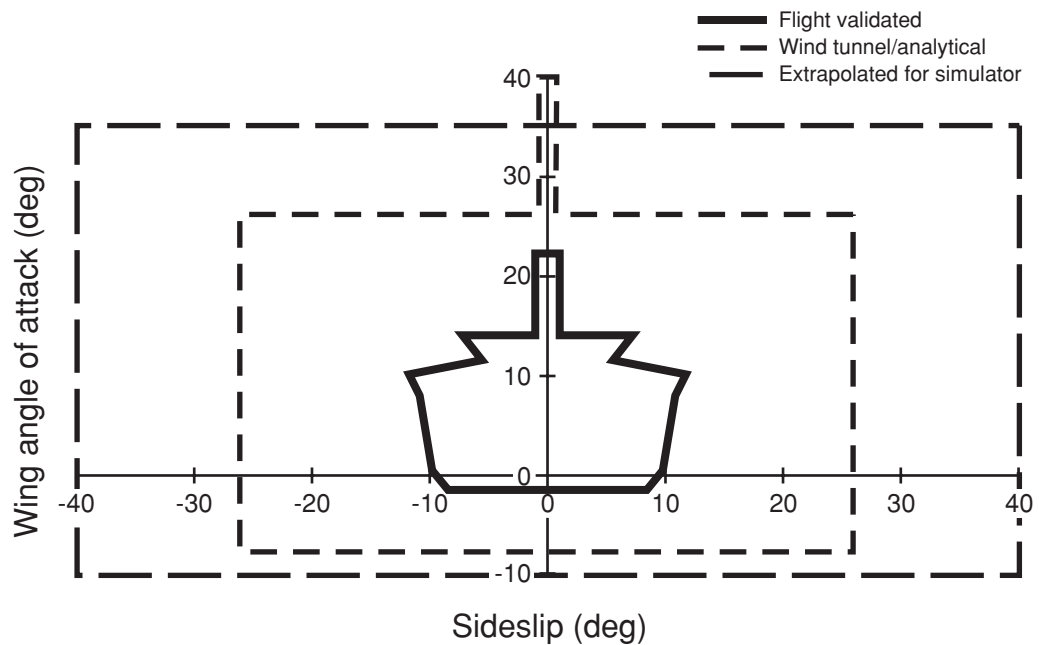

**MD-11 Flaps Up Alpha/Beta Envelope**

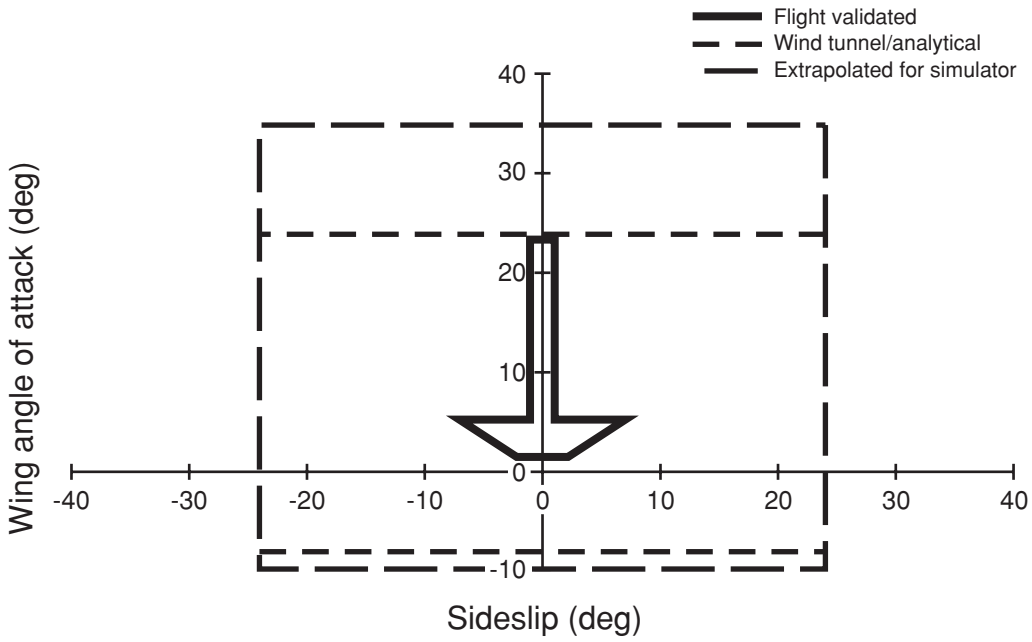

**MD-11 Alpha/Beta Envelope Flaps Deflected**

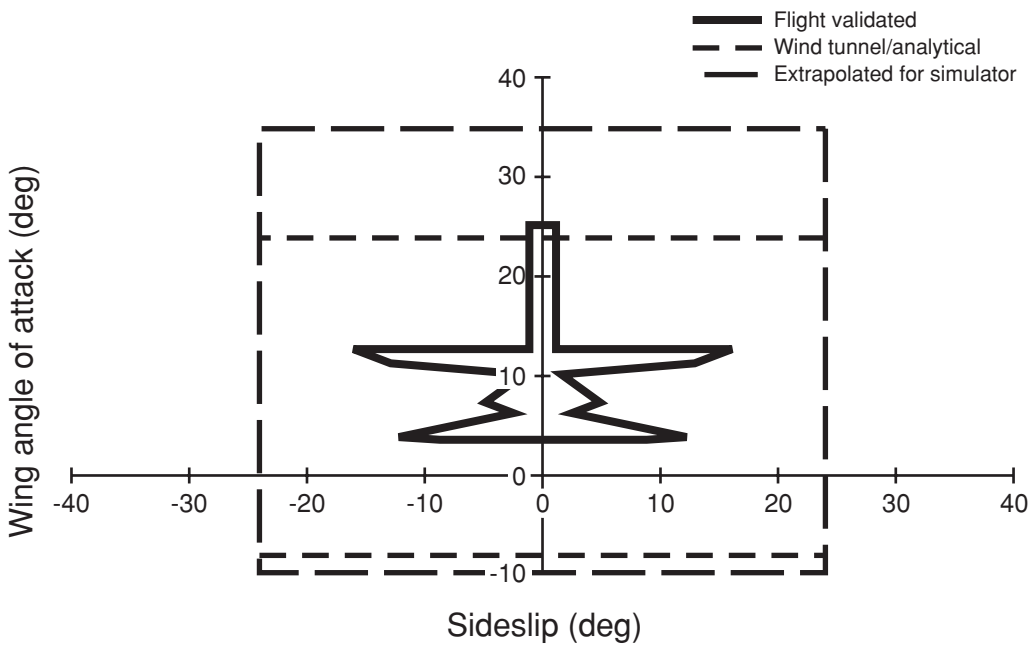





# Airplane Upset Recovery High Altitude Operations

# 3-E

Airplane Upset Recovery – A paper copy of the presentation with descriptive words for each one that can be used for a classroom presentation is contained in this Appendix.

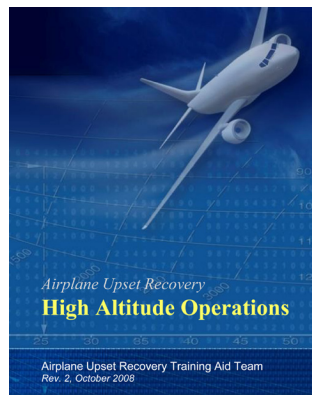

## Presentation

(This page intentionally left blank)



- This document is intended to supplement the Airplane Upset Recovery Training Aid Rev 1 that was released in August 2004. It addresses the issues associated with operations, unintentional slowdowns, and recoveries in the high altitude environment. While the Airplane Upset Recovery Training Aid addressed airplanes with 100 seats or greater, the information in this document is directly applicable to most all jet airplanes that routinely operate in this environment. This information has also been inserted in the Airplane Upset Recovery Training Aid Rev 2 completed November 2008. Consult the operations manual for your airplane type, as that information takes precedent to the following guidance.

## High Altitude Operations

### Introduction

- National Transportation Safety Board (NTSB) tasking following high altitude loss of control accidents and other incidents:
  - Need to address operational issues - unintentional slowdowns and recoveries in the high altitude environment
- Industry working group - formed at the request of FAA
- Team Members:
  - Airlines, safety organizations, manufacturers, regulatory bodies, industry groups, and educational representatives
  - International in scope

Upset.2

- This working group was formed as a result of the United States National Transportation Safety Board (NTSB) recommendations from a high altitude loss of control accident and other recent accidents and incidents that have occurred under similar conditions. The NTSB recommendations stated that pilots should possess a thorough understanding of the airplane's performance capabilities, limitations, and high altitude aerodynamics. The guidance in this document is intended to supplement the Airplane Upset Recovery Training Aid in these areas.
- There have been other recent accidents where for various reasons (e.g. trying to top thunderstorms, icing equipment performance degradation, unfamiliarity with high altitude performance, etc.) crews have gotten into a high altitude slowdown situation that resulted in a stalled condition from which they did not recover. There have been situations where for many reasons (e.g. complacency, inappropriate automation modes, atmospheric changes, etc.) crews got into situations where they received an approach to stall warning. Some of the recoveries from these warnings did not go well. This supplement is intended to discuss these possible situations, and provide guidance on appropriate training and recommendations for knowledge, recognition, and recovery.
- For example, a recent incident occurred where an airplane experienced an environmental situation where airspeed slowly decayed at altitude. The crew only selected maximum cruise thrust, instead of maximum available thrust, and that did not arrest the slowdown. The crew decided to descend but delayed to get ATC clearance. Airplane slow speed buffet started, the crew selected an inappropriate automation mode, the throttles were inadvertently reduced to idle, and the situation decayed into a large uncontrolled altitude loss. This incident may easily have been prevented had the flight crew acted with knowledge of information and techniques as contained in this supplement.
- In another high altitude situation, the crew decided to use heading select mode to avoid weather while experiencing turbulence. The steep bank angle that resulted from this mode quickly caused slow speed buffeting. The crew's rapid inappropriate response to disconnect the autopilot and over-control the airplane into a rapid descent in poor weather exacerbated the situation. These real world examples provide evidence towards the need for more detailed training in high altitude operations.



*High Altitude Operations - Introduction***Training Aid Purpose**

Upset.3

- An industry working group was formed to develop this guidance at the request of the U.S. Department of Transportation, Federal Aviation Administration. The working group consisted, in scope, of both domestic and international organizational representatives from the airline, manufacturer, regulatory, industry trade, and educational segments.

# High Altitude Operations - Introduction

## Goal



“ Our goal is to educate pilots so they have the **knowledge** and **skill** to adequately operate their airplanes and prevent upsets in a high altitude environment.”

- The Airplane Upset Recovery Training Aid Team

Upset.4

- The goal of this group is to educate pilots so they have the knowledge and skill to adequately operate their airplanes and prevent upsets in a high altitude environment. This should include the ability to recognize and prevent an impending high altitude problem and increase the likelihood of a successful recovery from a high altitude upset situation should it occur.

*High Altitude Operations - Introduction***High Altitude Upsets****The upset - startle factor**

- When **not** properly avoided, managed, or flown
  - **Assures a self-induced upset**

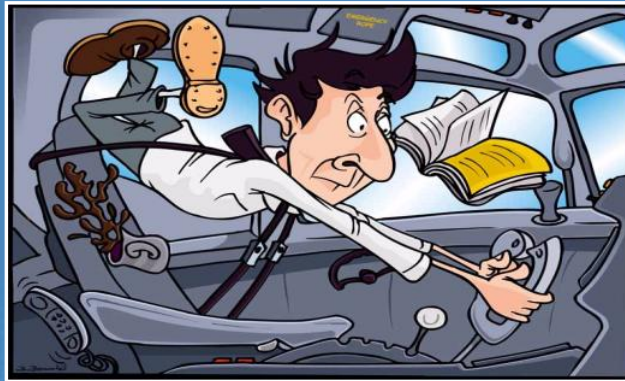

Upset.5

## *High Altitude Operations – Introduction*

### **High Altitude Basics**

At altitudes where the operational envelope is reduced:

- Be alert!! *No time for complacency*
- Recognize and confirm the situation
- Do not over control...Do not use large control movements – use small control pressures
- Be smooth with pitch and power to correct speed deviations



Upset.6

## *High Altitude Operations*

### **Presentation**

- High Altitude Aerodynamics – Principles
- High Altitude Operations – Flight Techniques
- High Altitude Operations – Additional Considerations
- High Altitude LOFT Training – Overview



Upset.7

This presentation will cover three main topics

1. High Altitude Aerodynamics – Understanding the Principles
2. Discussion of High Altitude Operations – Flight Techniques, and
3. Additional considerations and 4) an overview of High Altitude LOFT Training

### **High Altitude Aerodynamics**

- To cope with high altitude operations and prevent upset conditions, it is essential to have a good understanding of high altitude aerodynamics. This section represents terms and issues pilots need to understand thoroughly in order to successfully avoid upset conditions or cope with inadvertent encounters.

## High Altitude Aerodynamics

# Principles



### The Issue Today

- Recently, the industry has witnessed a number of accidents involving commercial and air transport-rated pilots who seem to lack fundamental knowledge of high altitude operations. The NTSB has asked the FAA to fix this problem. The high altitude environment has a number of specific references within regulations. They include: criteria defining maximum operating altitude and service ceiling, high altitude required training, flight crew member use of oxygen, passenger briefings, airspace issues, transponder usage, and RVSM requirements. Although this information is necessary knowledge for flight crews, this presentation will focus on the information necessary to prevent and recover from upsets in the high altitude environment.
- There are a number of aerodynamic principles that are necessary to understand to have a good grasp of high altitude performance.

## High Altitude Aerodynamics - Principles

# High Altitude Operations



- Knowledge of high altitude aerodynamics
- Pilot Training consists of:
  1. Knowledge and Familiarization
  2. Prevention - Avoidance Awareness
  3. Techniques - High altitude upset recovery

This training aid defines high altitude as -  
Altitudes above FL250

Note: The training aid will focus on the information necessary to prevent and recover from upsets in the high altitude environment

Upset.9

### Overview

- High altitude operations requires:
  1. A comprehensive understanding of high altitude aerodynamics.
  2. The pilot must translate that knowledge into a skill base that will provide a good margin of safety in the high altitude environment.
- This is accomplished through Training. This training should focus on knowledge, preventive measures by avoidance awareness, and the correct application of flight techniques during an upset conditions. The following section represents terms and issues pilots need to understand thoroughly in order to successfully avoid upset conditions or cope with inadvertent encounters.

### High altitude begins above FL250

- As a purely practical matter, it is useful to identify high altitude operations as those above flight level 250 (FL250 or 25,000 feet). The great majority of passengers and freight are now being carried in turbojet-powered airplanes, virtually all of which regularly operate at altitudes above FL250 where high speeds and best economy are attained. While aerodynamic principles and certain hazards apply at all altitudes, they become particularly significant with respect to loss of control (or upset) at altitudes above FL250. Among the more obvious examples are “coffin corner” and a pilot’s extremely short time of useful consciousness when deprived of oxygen at high altitude. For these reasons and others, this training aid defines high altitude as any altitude above FL250.

## High Altitude Aerodynamics - Principles

### L/D Max

The lowest point on the total drag curve – also known as  $V_{md}$  (minimum drag speed)

#### Pilot Tip

- Airspeed slower than L/D max known as: The “back side of the power-drag curve” or the “region of reverse command”
- Airspeed faster than L/D max is considered normal flight or the “front side of the power-drag curve”
- Normal flight – Speed stable  
Stable Flight - Airspeed disturbance (i.e. turbulence) - Airspeed will return to the original airspeed when the total thrust has not changed

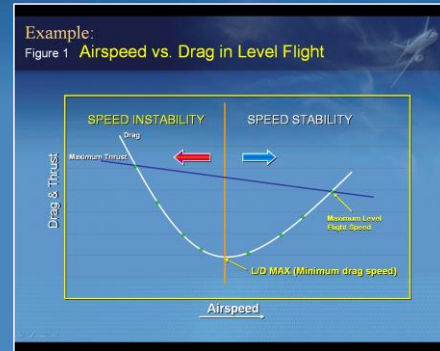

Upset.10

#### L/D Max

- The lowest point on the total drag curve (as indicated in figure 1) is known as L/D max (or  $V_{md}$ -minimum drag speed). The speed range slower than L/D max is known as slow flight, which is sometimes referred-to as the “back side of the power-drag curve” or the “region of reverse command”. Speed faster than L/D max is considered normal flight, or the “front side of the power-drag curve”.
- Normal flight (faster than L/D max) is inherently stable with respect to speed. When operating in level flight at a constant airspeed with constant thrust setting, any airspeed disturbance (such as turbulence) will result in the airspeed eventually returning to the original airspeed when the total thrust has not changed.



## High Altitude Aerodynamics - Principles

### L/D Max (continued)

#### Pilot Tip

Slower cruising speeds are a concern (approaching L/D max). There will be less time to recognize and respond to speed decay during high altitude cruise.

- Slow flight (slower than L/D max) – *Unstable*
- Lower speed – Result: increased drag
- Increased drag – Result: decrease in airspeed

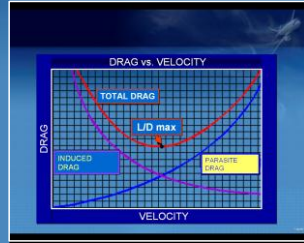

Ultimate uncorrected result – stalled flight condition

**Pilot Tip** Flight slower than L/D max at high altitudes must be avoided. Proper flight profiles and planning will ensure speeds slower than L/D max are avoided

Upset.11

#### L/D Max (continued)

- Slow flight (slower than L/D max) is inherently unstable with respect to speed and thrust settings. When operating at a constant airspeed with constant thrust setting, any disturbance causing a decrease in airspeed will result in a further decrease in airspeed unless thrust is increased.
- Lower speeds will subject the airplane to increased drag. This increase in drag will cause a further decrease in airspeed, which may ultimately result in a stalled flight condition.

#### Pilot Tip:

Flight slower than L/D max at high altitudes must be avoided. Proper flight profiles and planning will ensure speeds slower than L/D max are avoided.

*Example***Figure 1 – Airspeed Versus Drag in Level Flight**

Figure 1 Illustrates:

- Speed Stability vs. Speed Instability in relation to L/D Max (Minimum drag speed)
- Slow flight (slower than L/D max) is inherently unstable with respect to speed and thrust settings. When operating at a constant airspeed with constant thrust setting, any disturbance causing a decrease in airspeed will result in a further decrease in airspeed unless thrust is increased. As in Figure 1, the lower speed will subject the airplane to increased drag. This increase in drag will cause a further decrease in airspeed, which may ultimately result in a stalled flight condition. Flight slower than L/D max at high altitudes must be avoided due to the inefficiency and inherent instability of the slow flight speed range. When operating slower than L/D max, and where total drag exceeds total thrust, the airplane will be unable to maintain altitude and the only remaining option to exit the slow flight regime is to initiate a descent.

#### Additional information

- External factors, such as changing winds, increased drag in turns, turbulence, icing or internal factors, such as anti-ice use, auto-throttle rollback, or engine malfunction or failure can cause airspeed decay. Heavily damped auto-throttles, designed for passenger comfort, may not apply thrust aggressively enough to prevent a slowdown below L/D max.
- Slower cruising speeds are an issue. As airplanes are pushed to more efficient flight profiles to save fuel, it may dictate high altitude cruising at lower Mach numbers. The net result is the crew may have less time to recognize and respond to speed deterioration at altitude.
- At all times, pilots must ensure that flight slower than L/D max is avoided in the high altitude environment. Proper flight planning and adherence to published climb profiles and cruise speeds will ensure that speeds slower than L/D max are avoided.
- As an airplane climbs and cruises at high altitude, flight crews should be aware of terms that affect them.

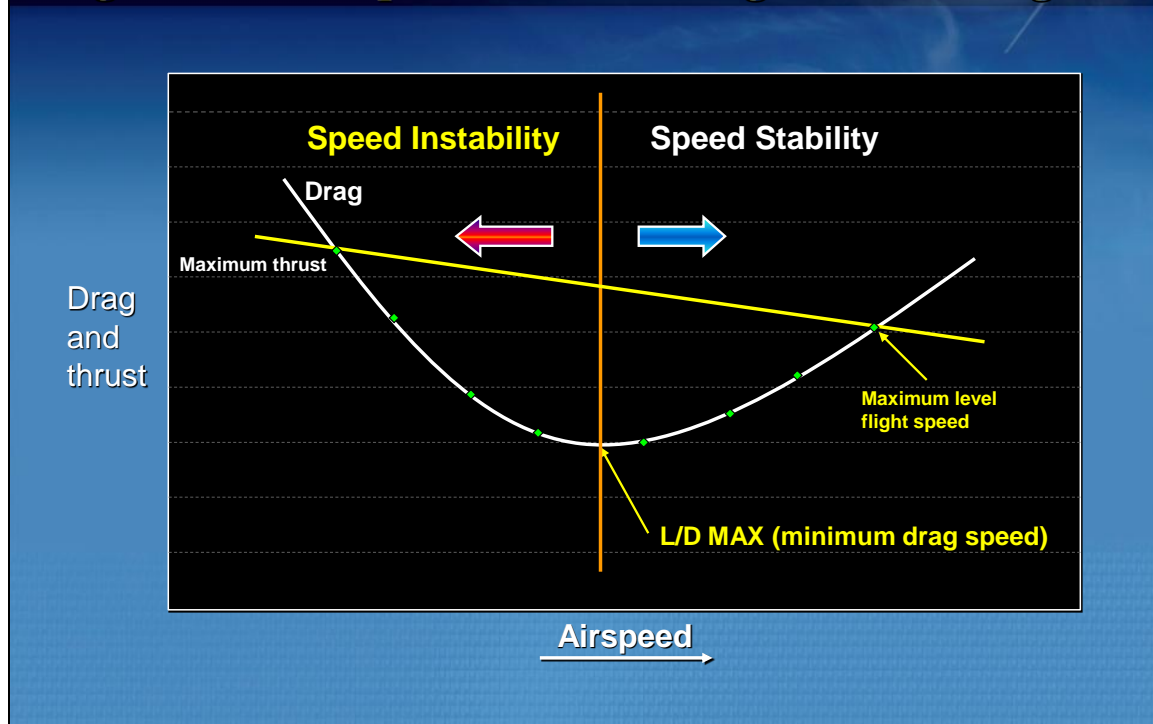
## High Altitude Aerodynamics - Principles

### Crossover Altitude

- Crossover Altitude is the altitude at which a specified CAS (Calibrated airspeed) and Mach value represent the same TAS (True airspeed) value. Above this altitude the Mach number is used to reference speeds

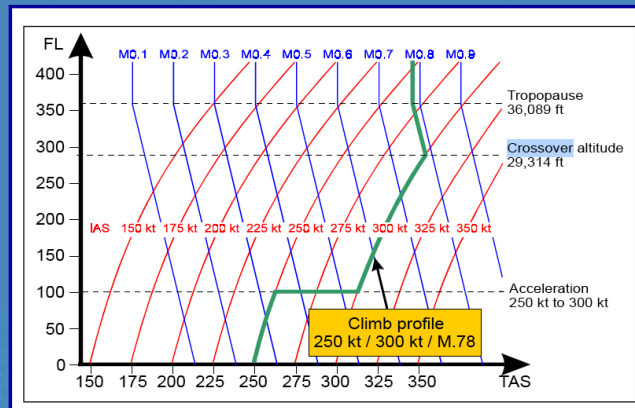

Typical climb profile

Upset.13

#### Principle - Crossover Altitude

- Crossover Altitude is the altitude at which a specified CAS (Calibrated airspeed) and Mach value represent the same TAS (True airspeed) value. Above this altitude the Mach number is used to reference speeds.
- Typical climb
  - The diagram illustrates a typical climb profile of 250 knots until 10,000 feet and then accelerating to 300 knots until crossover altitude is reached and continuing climb at the referenced Mach number.

## High Altitude Aerodynamics - Principles

### Optimum Altitude

- Cruise altitude for minimum cost operating in the ECON mode
- Minimum fuel burn when in the Long-range cruise (LRC) or pilot-selected speed modes
- The Optimum Altitude increases under the following conditions:
  - **ECON mode** – Airplane weight or cost index decreases
  - **LRC** or selected speed modes - Airplane weight or speed decreases
- Temperature - increase in temperature will lower the Optimum Altitude

#### Pilot Tip

When flying at Optimum Altitude, crews should be aware of temperature to ensure performance capability.

Upset.14

#### Optimum Altitude

- Optimum Altitude is defined as an altitude at which the equivalent airspeed for a thrust setting will equal the square root of the coefficient of lift over the coefficient of drag. In other terms the altitude where a given power setting produces an airspeed in which the dynamic pressure or air pressure the wing feels is the equivalent max range airspeed. The Optimum Altitude is not constant and will change over the period of a long flight as conditions and the weight of the aircraft change. A dramatic increase in temperature will change the Optimum Altitude. Therefore, when flying at Optimum Altitude, crews should be aware of temperature to ensure performance capability.
- Optimum Altitude is the cruise altitude for minimum cost when operating in the ECON mode, and for minimum fuel burn when in the LRC or pilot-selected speed modes. In ECON mode, Optimum Altitude increases as either airplane weight or cost index decreases. In LRC or selected speed modes, Optimum Altitude increases as either airplane weight or speed decreases. On each flight, Optimum Altitude continues to increase as weight decreases during the flight. For shorter trips, Optimum Altitude as defined above may not be achievable since the top of descent (T/D) point occurs prior to completing the climb to optimum.

## High Altitude Aerodynamics - Principles

# Optimum Climb Speed Deviations

- Optimum climb speed charts and speeds – AFM, FCOM, and FMS
- Increased rates of climb - ensure speed:
  - Not decreased below L/D max

*(Incident Data: Primary reason for slow speed events. Improper use of vertical speed modes during climb)*



### Pilot Tip

Enroute climb speed is automatically computed by FMC:

- Displayed - Climb and progress pages
- Displayed - Command speed when VNAV is engaged

Upset.15

### Optimum Climb Speed Deviations

- Airplane manuals and flight management systems produce optimum climb speed charts and speeds. When increased rates of climb are required, ensure speed is not decreased below L/D max. Evidence shows that inappropriate use of vertical speed modes is involved in the majority of slow speed events during high altitude climbs.

### Pilot Tip

Enroute climb speed is automatically computed by FMC:

- Displayed - Climb and progress pages
- Displayed - Command speed when VNAV is engaged

*High Altitude Aerodynamics - Principles***Thrust Limited Condition and Recovery**

- Be aware of outside temperature and thrust available
- Most jet transport aircraft are thrust limited, rather than slow speed buffet limited - especially in a turn
- Use Flight Management Systems/reduced bank angle
  - Real-time bank angle protection
  - Routine bank angle limit (10°-15°) for cruise flight

**Pilot Tip** If a condition or airspeed decay occurs, take immediate action to recover:

- Reduce bank angle
- Increase thrust – select maximum continuous thrust (MCT) if the aircraft is controlling to a lower limit
- Descend

Upset.16

**Thrust Limited Condition and Recovery**

- Most jet transport airplanes are thrust limited, rather than low speed buffet limited, at altitude, especially in a turn. It is imperative that crews be aware of outside temperature and thrust available. To avoid losing airspeed due to a thrust limit, use flight management systems/reduced bank angle as a routine for en-route flight if it incorporates real-time bank angle protection, or routinely select a bank angle limit of 10-15 degrees for cruise flight.

**Pilot Tip**

If a condition or airspeed decay occurs, take immediate action to recover:

- Reduce bank angle
- Increase thrust – select maximum continuous thrust (MCT) if the aircraft is controlling to a lower limit
- Descend

## High Altitude Aerodynamics - Principles

### Maximum Altitude

- Highest altitude at which an airplane can be operated - Lowest of:
  - **Maximum certified altitude** (Structural) - Determined during certification and is usually set by the pressurization load limits on the fuselage
  - **Thrust Limited Altitude** (Thrust) – Altitude at which sufficient thrust is available to provide a specific minimum rate of climb

Note: Depending on the thrust rating of the engines – Thrust Limited altitude may be above or below the maneuver altitude capability

- **Buffet or Maneuver Limited Altitude** (Aerodynamic) – Altitude at which a specific maneuver margin exists prior to buffet onset  
(FAA operations: 1.2g 33° Bank) (CAA/JAA operations: 1.3g 40° Bank)

Next Slide: Figure 2 – Optimum vs. Maximum Altitude

Upset.17

#### Maximum Altitude

- Maximum altitude is the highest altitude at which an airplane can be operated. In today's modern airplanes it is determined by three basic characteristics which are unique to each airplane model. It is the lowest of:
  - Maximum certified altitude (structural) that is determined during certification and is usually set by the pressurization load limits on the fuselage.
  - Thrust Limited Altitude – the altitude at which sufficient thrust is available to provide a specific minimum rate of climb.
  - Buffet or Maneuver limited altitude – the altitude at which a specific maneuver margin exists prior to buffet onset.
- Although each of these limits is checked by modern flight management computers the available thrust may limit the ability to accomplish anything other than relatively minor maneuvering.
- The danger in operating near these altitudes is the potential for the speed and angle of attack to change due to turbulence or environmental factors that could lead to a slowdown or stall and subsequent high altitude upset.
- In early turbojet era airplanes the capability to reach what is called absolute ceiling or “coffin corner” could exist. This is where if an airplane flew any slower it would exceed its stalling angle of attack and experience low speed buffet. Additionally, if it flew any faster it would exceed Mmo, potentially leading to high speed buffet.
- All airplanes are equipped with some form of stall warning system. Crews must be aware of systems installed on their airplanes (stick pushers, shakers, audio alarms, etc.) and their intended function. In a high altitude environment, airplane buffet is sometimes the initial indicator of problems.

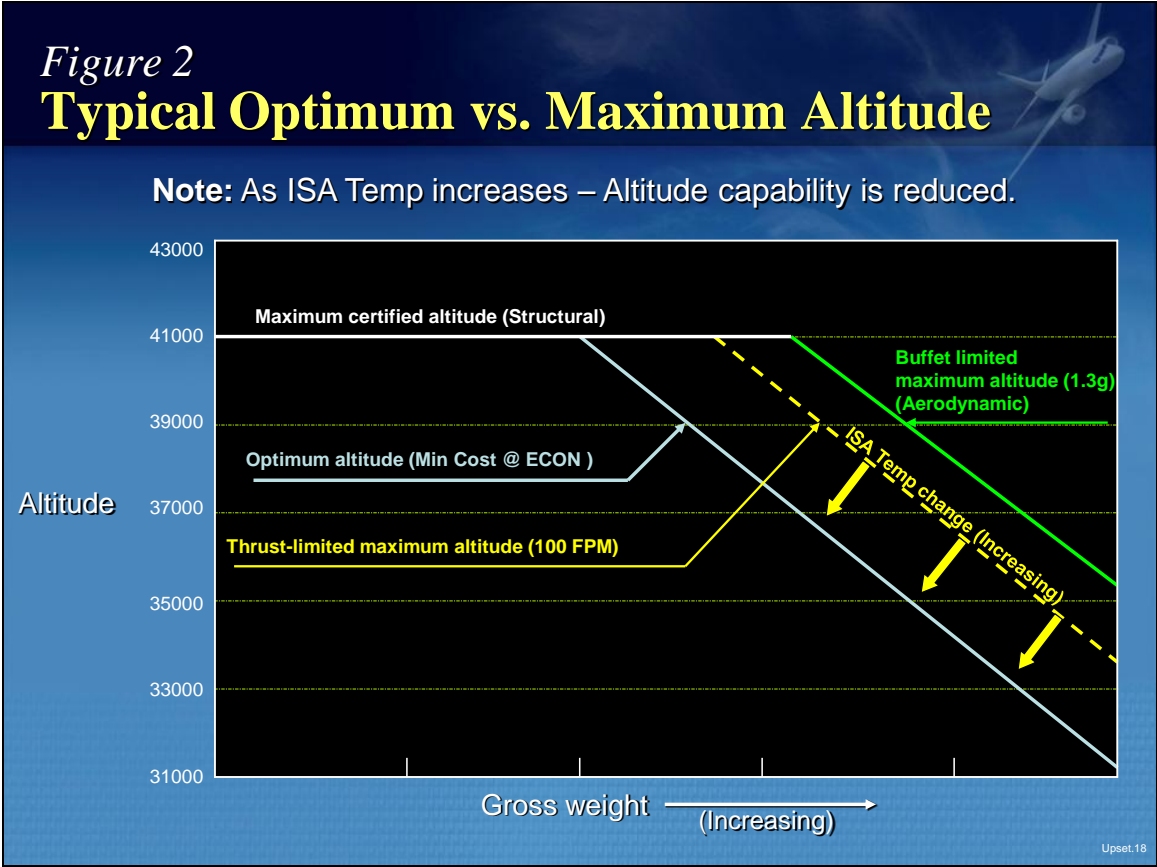

Figure 2 illustrates

- A typical transport category airplane optimum and maximum altitude capability. Note that 'with temperature increases' the maximum altitude capability decreases significantly. This is a situation where maneuver buffet margins are ok but temperature is affecting thrust capability to sustain airspeed at the higher altitudes.



## High Altitude Aerodynamics - Principles

# Maneuvering Stability

- Flight Characteristics:

Constant Airspeed – same control surface movement

### High altitude

- Higher pitch rate
- Less aerodynamic damping
- Greater angle of attack

### Low altitude

- Lower pitch rate
- More aerodynamic damping
- Less angle of attack

### Pilot Tip

High altitude flight normally has adequate maneuver margin at optimum altitude. Maneuver margin decreases significantly approaching maximum altitude.

**Pilot Tip** Do not over control airplane with large control movements – use small control inputs. Be smooth with pitch and power to correct speed deviations.

Upset.19

### Maneuvering Stability

- For the same control surface movement at constant airspeed, an airplane at 35,000 ft experiences a higher pitch rate than an airplane at 5,000 ft because there is less aerodynamic damping. Therefore, the change in angle of attack is greater, creating more lift and a higher load factor. If the control system is designed to provide a fixed ratio of control force to elevator deflection, it will take less force to generate the same load factor as altitude increases.
- An additional effect is that for a given attitude change, the change in rate of climb is proportional to the true airspeed. Thus, for an attitude change for 500 ft per minute (fpm) at 290 knots indicated air speed (KIAS) at sea level, the same change in attitude at 290 KIAS (490 knots true air speed) at 35,000 ft would be almost 900 fpm. This characteristic is essentially true for small attitude changes, such as the kind used to hold altitude. It is also why smooth and small control inputs are required at high altitude, particularly when disconnecting the autopilot.
- Operating limits of modern transport category airplanes are designed so that operations within these limits will be free of adverse handling characteristics. Exceeding these limits can occur for various reasons and all modern transport airplanes are tested to allow normal piloting skill to recover these temporary exceedences back to the normal operational envelope.

### Pilot tip

In the high altitude flight area there is normally adequate maneuver margin at optimum altitude. Maneuver margin decreases significantly as the pilot approaches maximum altitude. Flying near maximum altitude will result in reduced bank angle capability; therefore, autopilot or crew inputs must be kept below buffet thresholds. The use of LNAV will ensure bank angle is limited to respect buffet and thrust margins. The use of other automation modes, or hand flying, may cause a bank angle that result in buffeting. When maneuvering at or near maximum altitude there may be insufficient thrust to maintain altitude and airspeed. The airplane may initially be within the buffet limits but does not have sufficient thrust to maintain the necessary airspeed. This is a common item in many high altitude situations where airplanes slow down to the lower buffet limits. These situations can be illustrated with performance charts.

### Pilot tip

It is imperative to not overreact with large and drastic inputs. There is no need to take quick drastic action or immediately disconnect a correctly functioning autopilot. Pilots should smoothly adjust pitch and/or power to reduce speed should an overspeed occur.

## High Altitude Aerodynamics - Principles

### Buffet-Limited Maximum Altitude

- Two kinds of buffet in flight:
  1. Low speed buffet
  2. High speed buffet
- As altitude *increases*:
  - Indicated airspeed (IAS) for low speed buffet increases
  - High speed buffet speed decreases



*Result:* Margin between high speed and low speed buffet decreases

#### Pilot Tip

Respect buffet margins - Proper use of buffet boundary charts or maneuver capability charts and FMC calculations allows the crew to determine the maximum altitude.

Upset.20

#### Buffet-Limited Maximum Altitude

- There are two kinds of buffet to consider in flight; low speed buffet and high speed buffet. As altitude increases, the indicated airspeed at which low speed buffet occurs increases. As altitude increases, high speed buffet speed decreases. Therefore, at a given weight, as altitude increases, the margin between high speed and low speed buffet decreases.
- Altitude increases
  - Decrease margin between high speed and low speed buffet
  - Increases indicated airspeed at low speed buffet
  - High speed buffet speed decreases

#### Pilot Note

At a given weight, as altitude increases, the margin between high speed and low speed buffet decreases.

- Respect buffet margins. - Proper use of buffet boundary charts or maneuver capability charts can allow the crew to determine the maximum altitude
- High altitudes - Excess thrust available is limited

#### Pilot Note

Selecting MCT to provide additional thrust. In extreme airspeed decay situations, MCT may be insufficient. To prevent further airspeed decay into an approach to stall and stall situation – Descend using proper descent techniques.

## High Altitude Aerodynamics - Principles

### Buffet-Limited Maximum Altitude

- High altitudes - excess thrust is limited
  - If needed - Select maximum available/continuous thrust at any time

**Important:** If speed is decaying (airplane getting slow)

- Select Max Available Thrust

#### Pilot Tip

Select MCT to provide additional thrust. To prevent further airspeed decay into an approach to stall condition a descent may be necessary. Use proper descent techniques.

**Pilot Tip** Selecting MCT may be insufficient in extreme airspeed decay conditions.

Upset.21

#### Buffet-Limited Maximum Altitude

- Respect buffet margins. - Proper use of buffet boundary charts or maneuver capability charts can allow the crew to determine the maximum altitude that can be flown while still respecting the required buffet margins.
- At high altitudes the excess thrust available is limited. Crews must be aware that additional thrust is available by selecting maximum available/continuous thrust at any time. However, in extreme airspeed decay situations MCT may be insufficient. Proper descent techniques will be necessary in order to prevent further airspeed decay into an approach to stall and stall situation.

#### Pilot Note

Selecting MCT to provide additional thrust. In extreme airspeed decay situations MCT may be insufficient. To prevent further airspeed decay into an approach to stall and stall situation – Descend using proper descent techniques.

*High Altitude Aerodynamics - Principles***High Altitude Threats***Operating Near Maximum Altitude*

## Early Turbo-Jet Airplanes – “Coffin corner”

- As the altitude increases - pilot is always trying to maintain a safe airspeed above the stall and a safe airspeed below the  $V_{mo}/M_{mo}$
- Difference between the stall and the max speed narrows
  - Coffin corner
- Stall Warning Systems
  - “Stick Shakers”, “Pushers”, “Audio Alarms”
  - Know your airplane - systems installed and function

**Pilot Tip** Airplane Buffet is often a first indicator – Stay Alert!!

Upset.22

- In early turbo-jet era airplanes the capability to reach what is called absolute ceiling or “coffin corner” could exist. This is where if an airplane flew any slower it would exceed its stalling angle of attack and experience low speed buffet. Additionally, if it flew any faster it would exceed  $M_{mo}$ , potentially leading to high speed buffet.
- All airplanes are equipped with some form of stall warning system. Crews must be aware of systems installed on their airplanes (stick pushers, shakers, audio alarms, etc.) and their intended function. In a high altitude environment, airplane buffet is sometimes the initial indicator of problems.

## High Altitude Aerodynamics - Principles

# High Altitude Threats

## Operating Near Maximum Altitude (continued)

Limits are checked by FMC

### Note:

- Available thrust may limit ability to maneuver
- The amber band limits do not provide an indication of sufficient thrust to maintain the current altitude and airspeed

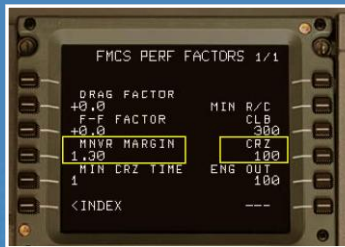

Upset.23

- Although each of these limits is checked by modern flight management computers the available thrust may limit the ability to accomplish anything other than relatively minor maneuvering.

## High Altitude Aerodynamics - Principles

### Amber Band

- Displays the range of reduced maneuver capability
- Provides 1.3g/40° of bank angle (default) margin to buffet
- Constant regardless of ambient temperature

#### Pilot Tip

The amber band does not give any indication of thrust limits.

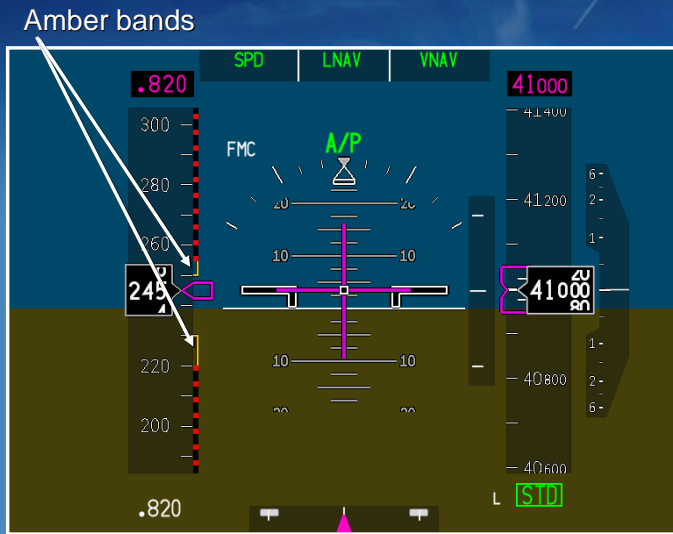

**Pilot Tip** The minimum maneuver speed indication does not guarantee the ability to maintain level flight at that speed.

Upset.24

#### The Amber Band

- Displays the maneuver speed
- Provides 1.3g/40 deg of bank angle (default) margin to buffet
- Constant regardless of ambient temperature

## High Altitude Aerodynamics - Principles

# High Altitude Maneuver

Examples: LNAV vs. HDG SEL



15° bank



30° bank

### Pilot Tip

For airplanes with real-time bank angle protection, the bank angle limiting function is only available when in LNAV – In HDG SEL bank angle protection is lost.

**Pilot Tip** Decelerating the airplane to the amber band may create a situation where it is impossible to maintain speed and/or altitude. When speed decreases, the airplane drag may exceed available thrust – especially in a turn.

Upset.25

- Maneuver margin decreases significantly as the pilot approaches maximum altitude. Flying near maximum altitude will result in reduced bank angle capability; therefore, autopilot or crew inputs must be kept below buffet thresholds.
- The use of LNAV will ensure bank angle is limited to respect buffet and thrust margins. The use of other automation modes, or hand flying, may cause a bank angles that result in buffeting. When maneuvering at or near maximum altitude there may be insufficient thrust to maintain altitude and airspeed. The airplane may initially be within the buffet limits but does not have sufficient thrust to maintain the necessary airspeed. This is a common item in many high altitude situations where airplanes slow down to the lower buffet limits. These situations can be illustrated with performance charts.

*Figure 3*  
**Drag vs. Mach Number**

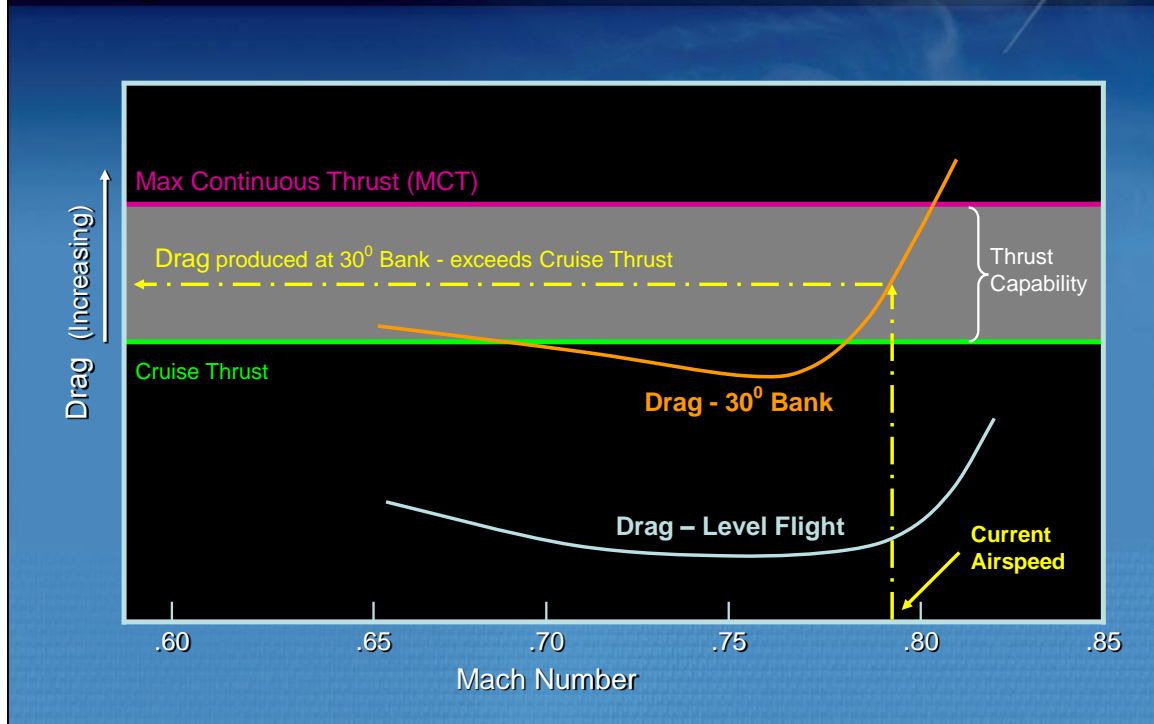

- Figure 3 shows that for normal cruise speeds there is excess thrust available at this fixed weight and altitude. When trying to turn at 30 degrees of bank the drag exceeds the normal maximum cruise thrust limit. If the pilot selects maximum continuous thrust then there is enough thrust to maintain the bank angle in the same situation.



## High Altitude Aerodynamics - Principles

### Weight & Balance Effects on Handling Characteristics

- Airplane Handling - Airplanes are typically loaded with an aft CG to improve enroute performance
  1. Aft loading - controls are more sensitive
    - Less longitudinal stability
  2. Loading toward the nose – CG moves forward
    - Longitudinal stability increases
- Weight and Balance limitations must be respected

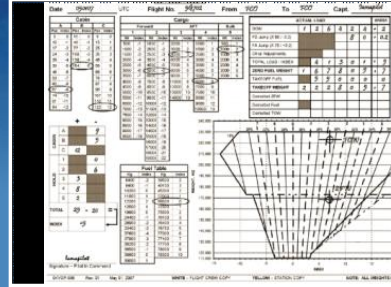

**Pilot Tip:** Airplane that is loaded outside the weight and balance envelope will result in aircraft handling that is unpredictable. Stall recovery may be severely impeded. This problem may be magnified at high altitude.

Upset.27

#### Weight & Balance Effects on Handling Characteristics

- From a pilots perspective, they should understand that, for conventional airplanes, an aft loading (at or approaching the aft limit of the weight and balance envelope) makes the airplane less stable.
- An aircraft loaded toward the nose results in more longitudinal stability. This stability increases as the CG moves forward. Since an airplane is dependent on the elevator to supply pitch control, the forward CG limit is established at a point where the increased stability will not exceed the ability of the elevator to provide this control. Additional force is required on the elevator to pull the nose up and the stall speed increases as the CG gets located farther
- Weight and Balance limitations must be respected. An airplane that is loaded outside the weight and balance envelope will not exhibit the expected level of stability and will result in aircraft handling that is unpredictable and may not meet certification requirements. This is a serious issue, particularly in an aft loading situation where stall recovery may be severely affected. The problem may be exacerbated at high altitude.
- At high altitude, an aft loaded airplane will be more susceptible to upset since it is less stable than a forward loading. Of interest to pilots is that the further aft an airplane is loaded, less effort is required by the tail to counteract the nose down pitching moment of the wing. The less effort required by the tail results in less induced drag on the entire airplane which results in the most efficient flight. Some airline load planning computers attempt to load airplane as far aft as possible to achieve efficiency. Some advanced airplanes use electronic controls to help improve airplane handling with aft loading.

## High Altitude Aerodynamics - Principles

# Mach Tuck and Mach Buffet

(Reference: FAA-H-8083-3A Airplane Flying Handbook)

- At speeds above  $M_{mo}$  (some airplanes) – mach tuck will occur
- Critical Mach Number – when airflow over wing reaches Mach 1.0
  - Shock wave will form over the wing
  - Mach buffet will occur
- Mach buffet increases with increased speed
  - Aft movement of the shock wave over the wing's center of pressure
  - Creates “tuck” (nose-down tendency). Because of the changing wing center of lift

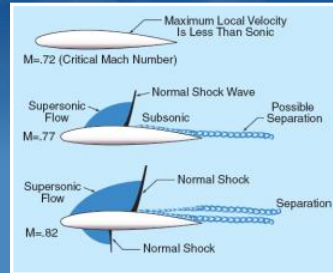

### Pilot Tip

In modern airplanes this has been largely eliminated.

Upset.28

## Mach Tuck and Mach Buffet

(Reference: FAA-H-8083-3A Airplane Flying Handbook)

- In some airplanes, at speeds above  $M_{mo}$ , a phenomenon called mach tuck will occur. As an airplane flies at the critical Mach number (the speed of an airplane at which airflow over any part of the wing first reaches Mach 1.0), a shock wave will form over the wing and mach buffet will occur. Mach buffet will continue to increase with increased speed and the aft movement of the shock wave, the wing's center of pressure also moves aft causing the start of a nose-down tendency or “tuck.” Because of the changing center of lift of the wing resulting from the movement of the shock wave, the pilot will experience pitch change down tendencies. In modern transport airplanes this phenomenon has been largely eliminated.

## High Altitude Aerodynamics - Principles

### Stalls

- An airplane wing can be stalled
  - Any airspeed, any altitude, any attitude

#### Pilot Tip

If the angle of attack is greater than the stall angle, the surface will stall. Attitude has no relationship to the aerodynamic stall. Even if the airplane is in a descent with what appears like ample airspeed - the surface can be stalled.

- Understand the difference between:
  1. “Approach” to stall recovery
  2. Stall recovery

*Dramatic difference in recovery technique*



### Know the Difference

#### Stalls

- Fundamental to understanding angle of attack and stalls is the realization that an airplane wing can be stalled at any airspeed and any altitude. Moreover, attitude has no relationship to the aerodynamic stall. Even if the airplane is in descent with what looks like ample airspeed, the surface can be stalled. If the angle of attack is greater than the stall angle, the surface will stall.
- Most pilots are experienced in simulator or even airplane exercises that involve approach to stall. This is a dramatically different condition than a recovery from an actual stall because the technique is not the same. The present approach to stall technique being taught for testing is focused on “powering” out of the non-stalled condition with emphasis on minimum loss of altitude. At high altitude this technique may be totally inadequate due to the lack of excess thrust. It is impossible to recover from a stalled condition without reducing the angle of attack and that will certainly mean a loss of altitude, regardless of how close the airplane is to the ground. Although the thrust vector may supplement the recovery it is not the primary control. At stall angles of attack, the drag is very high and thrust available may be marginal. Also, if the engine(s) are at idle, the acceleration could be very slow, thus extending the recovery. At high altitudes, where the available thrust will be reduced, it is even less of a benefit to the pilot. The elevator is the primary control to recover from a stalled condition, because without reducing the angle of attack, the airplane will remain in a stalled condition until ground impact, regardless of the altitude at which it started.
- Effective stall recovery requires a deliberate and smooth reduction in wing angle of attack. The elevator is the primary pitch control in all flight conditions, not thrust.

High Altitude Aerodynamics

# Flight Techniques



Upset.30

*High Altitude Aerodynamics – Flight Techniques***Remember the High Altitude Basics**

At altitudes where the operational envelope is reduced:

- Be alert!! *No time for complacency*
- Recognize and confirm the situation
- Do not over control... Do not use large control movements – use small control pressures
- Be smooth with pitch and power to correct speed deviations



Upset.31

## High Altitude Aerodynamics – Flight Techniques

# Altitude Exchange for Energy

## Stall Recovery

- Stall Recovery **is the Priority**
  - Altitude recovery is secondary to stall recovery
- Characteristics of stall:
  - Buffeting, which could be heavy at times
  - A lack of pitch authority
  - A lack of roll control
  - Inability to arrest descent rate
  - These characteristics are usually accompanied by a continuous stall warning

**Pilot Tip:** Stall recovery is the priority. Only after positive stall recovery, can altitude recovery be initiated. At high altitudes swept wing turbojet airplanes may stall at a reduced angle of attack due to Mach effects.

Upset.32

## Altitude Exchange for Energy

- Although stall angle of attack is normally constant for a given configuration, at high altitudes swept wing turbojet airplanes may stall at a reduced angle of attack due to Mach effects. The pitch attitude will also be significantly lower than what is experienced at lower altitudes. Low speed buffet will likely precede an impending stall. Thrust available to supplement the recovery will be dramatically reduced and the pitch control through elevator must be used. The goal of minimizing altitude loss must be secondary to recovering from the stall. Flight crews must exchange altitude for airspeed. Only after positive stall recovery has been achieved, can altitude recovery be prioritized.

### The recovery techniques assume the airplane is not stalled.

- An airplane is stalled when the angle of attack is beyond the stalling angle. A stall is characterized by any of, or a combination of, the following:
  - Buffeting, which could be heavy at times
  - A lack of pitch authority
  - A lack of roll control.
  - Inability to arrest descent rate.
- These characteristics are usually accompanied by a continuous stall warning.

## High Altitude Aerodynamics – Flight Techniques

# Altitude Exchange for Energy

## Stall Recovery (continued)

**Pilot Tip** Stall recovery requires that the angle of attack must be reduced below the stalling angle of attack. The elevator is the primary pitch control in all flight conditions... not thrust.

At High Altitude, recovery requires reducing the angle of attack

- The elevator is the primary control to recover from a stalled condition
  - Loss of altitude (regardless of close proximity to the ground)
  - Thrust vector may supplement the recovery - not the primary control
  - Stall angles of attack - drag is very high
  - Thrust available may be marginal, the acceleration could be slow

Upset.33

### Stalls

- Fundamental to understanding angle of attack and stalls is the realization that an airplane wing can be stalled at any airspeed and any altitude. Moreover, attitude has no relationship to the aerodynamic stall. Even if the airplane is in descent with appears like ample airspeed, the wing surface can be stalled. If the angle of attack is greater than the stall angle, the surface will stall.
- Most pilots are experienced in simulator or even airplane exercises that involve approach to stall. This is a dramatically different condition than a recovery from an actual stall because the technique is not the same. The present approach to stall technique being taught for testing is focused on “powering” out of the near-stalled condition with emphasis on minimum loss of altitude. At high altitude this technique may be totally inadequate due to the lack of excess thrust. It is impossible to recover from a stalled condition without reducing the angle of attack and that will certainly result in a loss of altitude, regardless of how close the airplane is to the ground. Although the thrust vector may supplement the recovery it is not the primary control. At stall angles of attack, the drag is very high and thrust available may be marginal. Also, if the engine(s) are at idle, the acceleration could be very slow, thus extending the recovery. At high altitudes, where the available thrust is reduced, it is even less of a benefit to the pilot. The elevator is the primary control to recover from a stalled condition, because, without reducing the angle of attack, the airplane will remain in a stalled condition until ground impact, regardless of the altitude at which it started.
- Effective stall recovery requires a deliberate and smooth reduction in wing angle of attack. The elevator is the primary pitch control in all flight conditions, not thrust.

*High Altitude Aerodynamics – Flight Techniques***High Altitude Threats***Operating Near Maximum Altitude*

- Airplane Icing
- Clear air turbulence
- Convective turbulence
- Wake turbulence
- Mountain wave
- High Level windshear
- Thunderstorms

**Pilot Tip**

High altitude weather can cause favorable conditions for upsets. Thorough route analysis is key to avoiding conditions that could lead to an upset.

Upset.34

- High altitude weather can cause favorable conditions for upsets. Thunderstorm, clear air turbulence, and icing are examples of significant weather that pilots should take into consideration in flight planning. Careful review of forecasts, significant weather charts, turbulence plots are key elements to avoiding conditions that could lead to an upset.
- There have been other recent accidents where for various reasons (trying to top thunderstorms, icing equipment performance degradation, unfamiliarity with high altitude performance, etc.) crews have gotten into a high altitude slowdown situation that resulted in a stalled condition from which they did not recover. There have been situations where for many reasons (complacency, inappropriate automation modes, atmospheric changes, etc.) crews got into situations where they received an approach to stall warning. Some of the recoveries from these warnings did not go well. This supplement is intended to discuss these possible situations, and provide guidance on appropriate training and recommendations for knowledge, recognition, and recovery.



## High Altitude Aerodynamics – Flight Techniques

# Slowdown or Stall at High Altitudes

## Weather Effects

- Know performance limits of the airplane
- The jet-stream – upper air currents - significant
  - Velocities – can be very high
  - Windshear can cause severe turbulence
  - Windshear – Substantial airspeed decay



### Pilot Tip

With upper air currents of decreasing velocity wind shear – the backside of the power curve *may be encountered*.

**Pilot Tip:** The pilot will have to either increase thrust or decrease angle of attack to allow the airspeed to build back to normal climb/cruise speeds. This may require trading altitude for airspeed to accelerate out. Failure to accelerate out of the backside of the power curve may result in the aircraft stalling.

Upset.35

## Weather effects that could cause a slowdown or stall at high altitudes

- High altitude flight, although generally at a relatively high true airspeed or Mach number, can be close to the performance limits of the airplane. The very low density air at high altitudes can result in a situation where the aircraft drag is at or near the higher of the two equilibrium points in the airplane speed - drag relationship, the power curve. Slowing below this point will cause the aircraft to continue to decelerate to the lower equilibrium speed, even as thrust is held constant. This situation is commonly called “being on the backside of the power curve”. The lower equilibrium point may be at or very close to the stall speed of the aircraft, depending on the thrust available. This phenomenon may be encountered in cruise flight at the upper altitude region of the flight envelope, and in climbs at lower altitudes.
- At high altitudes the upper air currents such as the jet-stream become significant. Velocities in the jet-stream can be very high and can present a beneficial tailwind or a troublesome headwind. Windshear at the boundaries of the jet-stream can cause severe turbulence and unexpected changes in airspeed or Mach number. This windshear, or other local disturbances, can cause substantial and immediate airspeed decreases in cruise, as well as climb situations. If the airplane is performance limited due to high altitude and subsequently encounters an area of decreasing velocity due to wind shear, in severe cases the back side of the power curve may be encountered. The pilot will have to either increase thrust or decrease angle of attack to allow the airspeed to build back to normal climb/cruise speeds. This may require trading altitude for airspeed to accelerate out of the backside of the power curve region if additional thrust is not available.

## *High Altitude Aerodynamics – Flight Techniques*

### **Icing**

#### *Use of Anti-Ice on Performance*

- Icing Conditions
  - Know anti-ice equipment limitations (flight manual requirements)
    - Temperature limitations
    - SAT (Static Air Temperature)
    - Changing environmental conditions
  - Thermal anti-ice – bleed penalty
    - Negative effect on the ability to recover from decaying airspeed
      - Airplane may not maintain cruise speed or cruise altitude

#### **Pilot Tip**

The bleed penalty for anti-ice results in a reduction of available thrust - increase in specific fuel consumption.

Upset.36

#### **ICING – Use of Anti-Ice on Performance**

- Icing conditions, as defined by the Airplane Flight Manual, determine when anti-icing equipment must be operated. Failure to do so would be a violation of AFM or company procedures. Pilots must be cognizant of all anti-ice equipment limitations and flight manual requirements and must be particularly aware of maximum and minimum temperature limitations and use anti-ice appropriately. Flight in changing temperature conditions may require different use of anti-ice equipment based on the SAT (Static Air Temperature) and changing environmental conditions. While some texts and aircraft manuals state that there is minimal chance of icing conditions occurring above 30,000 feet, pilots must understand that occasionally icing does occur at high altitudes and they must be prepared to use anti-ice. Careful monitoring of flight conditions is critical in this decision making.
- It must be remembered that thermal anti-ice robs the engine of bleed air. While bleed air is available at any time the engine is operating, it comes at a price. Power is required from the turbines to heat and compress the high pressure air that is bled from the engines. The penalty for air taken from the engine before going into the combustion chambers is a reduction in available thrust and an increase in specific fuel consumption.
- Appropriate and judicious use of anti-ice equipment at high altitude is very important. One must be aware of the fact that the use of anti-ice has a negative effect on the ability of an airplane to recover from a decaying airspeed situation. In some cases, it may not be possible to maintain cruise speed or cruise altitude at high altitude with anti-ice on. Pilots should also be aware of the specific flight planning parameters for their particular flight.

## High Altitude Aerodynamics – Flight Techniques

### In-Flight Icing Stall Margins

- Ice accumulation increases aircraft weight / drag
- Airplane may exhibit stall onset characteristics before stick shaker activation
- Automation during icing encounters
  - Autopilot and Auto-throttles can mask the effects of airframe icing
  - Autopilot can trim the airplane up to a stall
  - upset thus masking heavy control forces
  - Pilots have been surprised when the autopilot disconnected just prior to a stall



**Pilot Tip** In-flight icing - **Serious Hazard** - stalls at much higher speeds and lower angles of attack. If stalled, the airplane can roll / pitch uncontrollably.

Upset.37

#### In-flight Icing Stall Margins

- In-flight icing is a serious hazard. It destroys the smooth flow of air on the airplane, increasing drag, degrading control authority and decreasing the ability of an airfoil to produce lift. The airplane may stall at much higher speeds and lower angles of attack than normal. If stalled, the airplane can roll or pitch uncontrollably, leading to an in-flight upset situation.
- Even with normal ice protection systems operating properly, ice accretion on unprotected areas of the airplane may significantly increase airplane weight and drag.
- Activation of an artificial stall warning device, such as a stick shaker, is typically based on a pre-set angle of attack. This setting gives a warning prior to actual stall onset where buffeting or shaking of the airplane occurs. For a clean airplane, the pilot has adequate warning of impending stall. However, with ice, an airplane may exhibit stall onset characteristics before stick shaker activation because of the effect of ice formations on reducing the stall angle-of-attack. In this case, the pilot does not have the benefit of a stick shaker or other stall warning.
- Flight crews must be especially wary of automation during icing encounters. Autopilots and auto-throttles can mask the effects of airframe icing and this can contribute to ultimate loss of control. There have been several accidents in which the autopilot trimmed the airplane right to a stall upset situation by masking heavy control forces. If the autopilot disengages while holding a large roll command to compensate for an asymmetric icing condition (or other similar problem causing roll), an immediate large rolling moment ensues for which the pilot may not be prepared, resulting in a roll upset. Pilots have been surprised when the autopilot automatically disconnected with the airplane on the brink of a stall.

## High Altitude Aerodynamics – Flight Techniques

### In-Flight Icing Stall Margins (continued)

- Adverse Weather Conditions: Stay Alert – Avoidance/Monitor
- Thunderstorm, clear air turbulence, and icing

#### Avoid potential upset conditions

- Monitor significant weather
- Update weather information
- Important - Trend monitoring of turbulence
- Review turbulence charts



**Pilot Tip** Adverse weather avoidance is crucial. It is most important that proper airspeed is maintained. Keep an adequate margin above stall, remember that indicated stall speed is increasing and stall alpha is lowering. There are no reliable rules of thumb for icing speeds.

Upset.38

#### In-flight Icing Stall Margins

- Wing ice accretion sometimes causes the wing to stall before stick shaker activation. Some autopilots are designed with control laws that enable them to continue to operate until they get to stick shaker. Alternatively, the autopilot may disconnect early because of excessive roll rates, roll angles, control surface deflection rates, or forces that are not normal. These autopilots are not malfunctioning; they are conforming to design parameters.
- It is most important that proper airspeed is maintained. It is important to keep an adequate margin above stall, remembering that indicated stall speed is increasing and stall alpha is lowering. Unfortunately, there are no reliable rules of thumb for icing speeds.
- High altitude weather can cause favorable conditions for upsets. Thunderstorm, clear air turbulence, and icing are examples of significant weather that pilots should take into consideration in flight planning. Careful review of forecasts, significant weather charts, turbulence plots are key elements to avoiding conditions that could lead to an upset.
- Once established in cruise flight, the prudent crew will update weather information for the destination and enroute. By comparing the updated information to the preflight briefing, the crew can more accurately determine if the forecast charts are accurate. Areas of expected turbulence should be carefully plotted and avoided if reports of severe turbulence are received. Trend monitoring of turbulence areas is also important. Trends of increasing turbulence should be noted and if possible avoided. Avoiding areas of potential turbulence will reduce the risk of an upset.

## High Altitude Aerodynamics – Flight Techniques

# Primary Flight Display Airspeed Indications

- Modern aircraft are equipped with a primary flight display (PFD)
  - Help you maintain a safe airspeed margins
  - Airspeed trending

### Important

These displays do not indicate if adequate thrust is available to maintain the current airspeed and altitude



Upset.39

## Primary Flight Display Airspeed Indications

- Modern Aircraft airplanes that are equipped with a primary flight display (PFD) typically provide information that will help you maintain a safe airspeed margin between the low and high speed limits. Most of these airplanes have an indication of airspeed trending. This is important because these displays do not indicate that adequate thrust is available at that altitude to maintain the current airspeed. Older airplanes had charts in the performance section that depicted adequate speed ranges for a given altitude and weight.

## High Altitude Aerodynamics – Flight Techniques

# Flight Techniques of Jet Aircraft

## Automation During High Altitude Flight

- Automation during cruise
  - Attempts to maintain altitude and airspeed
  - Thrust will increase to selected cruise limit
  - Select MCT (Max Cont Thrust) - to increase available thrust and stop airspeed decay
- Airspeed continues to deteriorate - the only option is to descend



### **Pilot Tip** Pilot must take action before excessive airspeed loss

- The pilot's action - pitch down - increase the airspeed while being in an automation mode that keeps the throttles at maximum thrust
- Autopilot engaged - select a lower altitude - use an appropriate mode to descend
- If the aircraft is not responding quickly enough you must take over manually
- Re-engage autopilot once in a stable descent and the commanded speed has been reestablished

Upset.40

## Automation During High Altitude Flight

- During cruise at high altitude the autopilot will be engaged with the pitch in an altitude hold mode and the throttles in a speed mode. However, it is possible that due to changing conditions (increasing temperature, mountain wave, etc.) or poor planning, an airplane could be thrust limited and not be able to maintain the desired altitude and/or airspeed. Regardless, the airplane's automatic control system will try to maintain this altitude by increasing thrust to its selected limit. When the thrust is at the maximum limit the pitch may continue to increase to maintain altitude and the airspeed then continues to decay. The only option then is to descend. The pilot's action should be to pitch down and increase the airspeed while being in an automation mode that keeps the throttles at maximum thrust. If the autopilot is still engaged, select a lower altitude and use an appropriate mode to start the aircraft down. However, if the aircraft is not responding quickly enough you must take over manually. Pilots must assess the rate at which vertical speed and airspeed increase is occurring to make this determination. This does not imply that aggressive control inputs are necessary. The autopilot can then be reengaged once the airplane is in a stable descent and the commanded speed has been reestablished. Do not attempt to override the autopilot, it is always better to disconnect it before making manual control inputs. Due to RVSM considerations and large altitude losses, crews should consider turning off course, avoiding large bank angles during descent, and monitoring TCAS to reduce the potential for collisions. Crews should also inform ATC of their altitude deviations.

*High Altitude Aerodynamics – Flight Techniques***Flight Techniques of Jet Aircraft***Automation During High Altitude Flight (continued)*

- Vertical Speed Mode (VS) at high altitude - must be clearly understood
  - Energy management, available thrust is reduced at high altitude
  - Manage speed on either elevator or with thrust
  - VS mode, airplane speed controlled by thrust
  - Use of VS has considerable risk during high altitude climb
  - VS mode prioritizes the commanded VS rate
  - Speed can decay, thrust available is less than thrust required
  - Improper use of VS can result in speed loss

**Pilot Tip** General guideline - VS mode should not be used for climbing at high altitudes

**Pilot Tip** VS can be used for descent - selecting excessive vertical speeds can result in airspeed increases into an overspeed condition

Upset.41

- The consequences of using Vertical Speed (VS) at high altitude must be clearly understood. Most autoflight systems have the same logic for prioritizing flight path parameters. The fundamental aspect of energy management is to manage speed by either elevator or with thrust. When using the VS mode of the Auto Flight System (AFS), airplane speed is normally controlled by thrust. If a too high vertical descent rate is selected the autothrottle will reduce thrust to idle and the airspeed will start to increase above the commanded airspeed. The reverse situation can occur with considerable risk if an excessive climb rate is selected. In that case, if the thrust available is less than the thrust required for that selected vertical speed rate the commanded speed will not be able to be held and a speed decay will result. On some airplanes, improper use of VS can result in speed loss and eventually a stall.
- Pilots must understand the limits of their airplanes when selecting vertical modes. As a general guideline, VS should not be used for climbing at high altitudes. Reduced thrust available at high altitudes means that speed should be controlled through pitch and not with thrust. VS can be used for descent; however, selecting excessive vertical speeds can result in airspeed increases into an overspeed condition. Using a mode that normally reduces thrust, when the need arises to descend immediately, may not be appropriate for a low speed situation. Either disconnect autothrottles, or use a mode that keeps the throttles at maximum available thrust in these situations.

*High Altitude Aerodynamics – Flight Techniques***Human Factors and High Altitude Upsets**

- The Startle Factor
  - Dynamic buffeting and large changes in airplane attitude



Upset.42

**Human Factors and High Altitude Upsets**

- The flightcrew may be startled by unexpected low airspeed stall warnings, dynamic buffeting and large changes in airplane attitude (design dependent) especially when the airplane is on autopilot. While flightcrews receive training on systems such as stick shakers to alert the pilots of impending stall, normally they do not receive training in actual full stall recovery, let alone stall recovery at high altitudes.



## *High Altitude Aerodynamics – Flight Techniques*

# Human Factors and High Altitude Upsets

*(continued)*

- Pilot training – conventional
  - Typical crew training
  - Trained to respond to stall warnings – “Approach to Stall”
  - Usually limited to low altitude recovery
- High altitude - stalls
  - Low speed buffet mistaken for high speed buffet
  - Actual full “Stall Recovery”
  - Higher altitudes
    - Available thrust is insufficient
    - Reduce the angle of attack
    - Trade altitude for airspeed.
- Recognition for recovery is sometimes delayed



Upset.43

### Human Factors and High Altitude Upsets

- Flight crews are inclined to respond to high altitude stalls like they have been trained to respond to stall warnings, but the procedures for the latter are neither effective nor proper for stall recovery. Furthermore, unlike the conditions for which the flightcrew is trained to respond to stall warnings at lower altitudes, at the higher altitudes the available thrust is insufficient, alone, to recover from a stall. The only effective response is to reduce the angle of attack and trade altitude for airspeed. Pilots have also reported that low airspeed buffet was mistaken for high speed buffet which prompts an incorrect response to reduce airspeed when approaching a low airspeed stall. As in any emergency situation, if the airplane is designed with effective alerting (actual and/or artificial) and the flightcrew is adequately trained to recognize the indicators of the stall, these will lead to appropriate flight crew recovery actions as discussed in the next paragraph. Equally important is that crews be familiar with stall warning and recognition devices, such as stick pushers, in order to understand their operation.

*High Altitude Aerodynamics – Flight Techniques***Human Factors and High Altitude Upsets***(continued)*

## Reasons for delayed recovery

1. Concern for passenger and crew safety following large control movements
2. Previous training emphasized altitude loss
3. Anxiety associated altitude violations and other ATC concerns
4. Less experience with manual flight control at high speed / altitude
5. Lack of understanding - Unaware of the magnitude of altitude loss as it relates to the recovery from the upset condition

**Human Factors and High Altitude Upsets**

- Once the pilot recognizes the airplane is in full aerodynamic stall, immediate corrective actions and decisions required for airplane recovery are sometimes delayed by the flightcrew. Some of the reasons for the delay include 1) legitimate concern for passenger and crew safety following large control movements, 2) previous training emphasizing altitude loss of only a few hundred feet even for high altitude stalls 3) anxiety associated altitude violations and other air traffic, 4) less experience with manual flight control and 5) even the de facto acknowledgement of loss of control represented by loss of altitude. While the magnitude of required flight control input will vary by airplane design for recovery, flightcrews should be trained to expect a longer recovery time and greater altitude loss while the airplane accelerates to gain airspeed following high altitude stall.
- Also, since there is no detailed checklist or procedure telling the pilot when to start the stall recovery and how much back pressure should be used for return to level flight after stall recovery, these techniques need to be adequately trained. For example during stall recovery, pilots gauge how assertively they can pull back by using stick shaker activation to indicate when to reduce back pressure. Other pilots may use angle of attack limit indications on the attitude indicator (if equipped) to aid in the stall recovery. Pilots should also be aware that an aggressive stall recovery and subsequent altitude recapture can result in a secondary stall during stall recovery as the pilot discovers the correct level of control inputs required to recover the airplane. On the other side there is the concern of accelerating into high speed buffet during the recovery if the airplane is allowed to accelerate too much.

# High Altitude Operations

## Additional Considerations



Upset.45

*High Altitude Operations – Additional Considerations***Multi-Engine Flame Out***Demands Immediate Action*

- Prompt recognition of the engine failures – utmost importance
- Immediately accomplishment of the recall items and/or checklist associated with loss of all engines
  - Establish the appropriate airspeed (requires a manual pitch down) to attempt a windmill relight
  - Driftdown will be required to improve windmill starting capability
  - Inflight start envelope is provided to identify proper windmill start parameters

**Pilot Tip** Regardless of the conditions and status of the airplane - strict adherence to the checklist is essential to maximize the probability of a successful relight.

**Pilot Tip** Recognition tip – autopilots and A/T may disconnect or indications of electrical problems may exist with a multi-engine flameout.

Upset.46

**Additional Considerations***Multi-Engine Flame Out*

- At high altitudes, as a result of very low airspeed, stall conditions, or other occurrences an all engine flameout may occur. This is easily detected in cruise but may be more difficult to detect during a descent. The all engine flameout demands prompt action regardless of altitude and airspeed. After recognition, immediate accomplishment of the recall items and/or checklist associated with the loss of all engines is necessary to quickly establish the appropriate airspeed (requires a manual pitch down) and to attempt a windmill relight. It should be noted that loss of thrust at higher altitudes (above 30,000 feet) may require driftdown to a lower altitude to improve windmill starting capability. Additionally, even though the inflight start envelope is provided to identify the region where windmill starts can occur, it is often demonstrated during certification this envelope does not define the only areas where a windmill start may be successful. Regardless of the conditions and status of the airplane, strict adherence to the checklist is essential to maximize the probability of a successful relight.

## High Altitude Operations – Additional Considerations

### Corelock

- Turbine engine – abnormal thermal event (e.g flameout at low airspeed)  
*Result* - the “core” of the engine stops or seizes
  - Insufficient airspeed - insufficient airflow through the engine
  - Engine – restart capability only when seized engine spools begin to rotate
- Pilot Tip** After all engine flameouts
- The first critical consideration is to obtain safe descent speed
  - Determine engine status
  - If engine spools indicate zero - core lock may exist/mechanical engine damage
  - Crews must obtain best L/D<sub>Max</sub> airspeed instead of accelerating to windmill speed
- **Critical:** The crew must follow the approved flight manual procedures, maintain sufficient airspeed to maintain core rotation

Upset.47

### Corelock

- Core lock is a phenomenon that could, in theory, occur in any turbine engine after an abnormal thermal event (e.g. a sudden flameout at low airspeed) where the internal friction exceeds the external aerodynamic driving forces and the “core” of the engine stops. When this occurs, differential contraction of the cooler outside case clamps down on the hotter internal components (seals, blade tips etc.) preventing rotation or “locking the core.” This seizure may be severe enough to exceed the driving force available by increasing airspeed or from the starter. If differential cooling locks the core, only time will allow the temperature difference to equalize, reduce the contact friction caused by differential contraction and allow free rotation.
- After all engine flameouts, the first critical item is to obtain safe descent speed. Then flight crews need to determine engine status. If any of the engine spools indicate zero RPM then a situation of core lock may exist or mechanical engine damage could have occurred. If this case applies to all engines, crews must obtain best L/D airspeed instead of accelerating to windmill speed, to obtain an optimum glide ratio. Crews then should consider their forced landing options. In the event the seized spool(s) begin to rotate a relight will be contemplated and windmill airspeed may be necessary.

## *High Altitude Operations – Additional Considerations*

### **Rollback**

- Turbine engine rollback - uncommanded loss of thrust
  - Reduced  $N_1$  RPM - increase in EGT
  - Many causal factors:
    - Moisture
    - Icing
    - Fuel control issues
    - High angle of attack disrupted airflow
    - Mechanical failure

**Pilot Tip** If airspeed stagnation occurs, check appropriate thrust level. This is important as well as increasing airspeed in the case of an engine has rollback.

Upset.48

### **Rollback**

- Turbine engine rollback is an uncommon anomaly consisting of an uncommanded loss of thrust (decrease in EPR or  $N_1$ ), which is sometimes accompanied by an increase in EGT. Rollback can be caused by a combination of many events including moisture, icing, fuel control issues, high angle of attack disrupted airflow, and mechanical failure and usually results in flameout or core lockup. Modern airplanes alleviate most rollback issues with auto-relight. Additionally, updated progressive maintenance programs identify potential problems and help to decrease rollback events. It is conceivable that pilots would recognize the results of rollback rather than the rollback event itself depending on workload and flight experience. If airspeed stagnation occurs, checking of appropriate thrust levels is important as well as increasing airspeed in the case where an engine has rolled back.

## High Altitude Loft Training



## High Altitude Loft

### Overview

- **Recommendation**

A high altitude loft is recommended by industry

- **Purpose**

To familiarize crews with high altitude slowdowns and approach to stall

- **Training Imperatives**

- Crews should always recover at the first indication of an impending stall
- Operators may modify this scenario for specific airplane models within their operation



Upset.50

### High Altitude Loft Scenario

- The following loft scenario is recommended by industry as a way of familiarizing crews with high altitude slowdowns and approach to stall. Crews should always recover at the first indication of an impending stall.



## High Altitude Loft

### Purpose

Purpose of the High Altitude LOFT training:

1. Train crews to **recognize** the high altitude threat due to airplane slowdown and approach to stall
2. Assist crews in how to **manage** this threat
3. The exercise is **not intended** to train an actual jet upset or full stall
4. Train only to the **indications of an approach to stall** before a recovery is initiated

**Operators** Should consider all the scenario factors that will lead to realistic recovery techniques. Operators should determine the optimum conditions in setting up this scenario.

Upset.51

- The purpose of this LOFT training aid is to assist operators of high altitude jet aircraft. The high altitude slowdown to an approach to stall represents a threat that has resulted in accidents and incidents when mismanaged. This simulator training is to assist crews in managing this threat. The exercise is not intended to train an actual jet upset or full stall, it only has the airplane reach the indications of an approach to stall before a recovery is initiated. Operators should consider a number of factors to determine how realistic their simulator will respond to this training scenario. Operators should determine the optimum manner to set up this scenario to achieve the high altitude training goals.

*High Altitude Loft***Training Goal**

- Reinforce understanding of high altitude characteristics
- How to determine cruise altitude capability
- Reinforce acceptable climb techniques and – understand the risks associated with various climb techniques – ie. vertical speed (VS)
- Recognize an approach to stall and apply proper recovery techniques
- Discuss automation factors - ie. mode protections, hazards of split automation and inappropriate modes
- Address intuitive and incorrect reactions to stall warning indications
- Develop procedures that are widely accepted to recover from impending high altitude stall conditions with and without auto-flight systems

Upset.52

**Training Goals**

- Reinforce understanding of high altitude characteristics
- How to determine cruise altitude capability
- Reinforce acceptable climb techniques and – understand the risks associated with various climb techniques – ie. vertical speed (VS)
- Recognize an approach to stall and apply proper recovery techniques
- Discuss automation factors - ie. mode protections, hazards of split automation and inappropriate modes
- Address intuitive and incorrect reactions to stall warning indications
- Develop procedures that are widely accepted to recover from impending high altitude stall conditions with and without auto-flight systems

*High Altitude Loft***Summary****Purpose of this training module**

- Present an overview of operational issues and how they may contribute to unintentional slowdowns in the high altitude environment
- Discuss aerodynamic principles relating to flight in high altitude environment
- Present pilot tips and techniques for high altitude upset recovery and slowdowns
- Identify factors to aid in early recognition of unintentional slowdowns
- Discuss the training goals for simulator high altitude loft training

Upset.53



## References for Additional Information

### 4.0 Introduction

The overall goal of the *Airplane Upset Recovery Training Aid* is to increase the ability of pilots to recognize and avoid situations that can lead to airplane upsets and improve the pilots' ability to recover control of an airplane that has exceeded the normal flight regime. Several primary references used during the research and development of this training aid provide excellent additional information that is beyond the scope of this training aid. The references listed in this section are intended to assist those responsible for development of classroom material in locating additional material. These references may also be used as a resource for answering questions raised in the training process.

### 4.1 References

- *Aerodynamics For Naval Aviators*, H. H. Hurt, Jr., University of Southern California, United States Navy NAVAIR 00-80T-80: January 1965, The Office of the Chief of Naval Operations, Aviation Division.
- *Airplane Performance, Stability, and Control*, Courtland D. Perkins and Robert E. Hage, John Wiley & Sons, Inc., New York: January 1967
- *Handling the Big Jets*, D. P. Davis, Brabazon House, Redhill, Surrey, England, third edition, December 1971.
- *Instrument Flight Procedures*, United States Air Force Manual 11-217, Volume I, 1 April 1996, Department of the Air Force, HQAFFSA/CC, Publishing Distribution Office.
- *Instrument Flying Handbook*, U.S. Department of Transportation, Federal Aviation Administration, Superintendent of Documents, U.S. Government Printing Office, Washington, DC 20402.
- *Turbulence Education and Training Aid*, U.S. Department of Transportation, Federal Aviation Administration, Air Transport Association of America, The Boeing Company, National Technical Information Service, 5285 Port Royal Road, Springfield, VA 22161.
- *Van Sickle's Modern Airmanship, 6th edition*, edited by John F. Welsh, TAB Books, division of McGraw-Hill, Inc.
- *Wake Turbulence Training Aid*, U.S. Department of Transportation, Federal Aviation Administration, DOT/FAA/RD-95/6, DOT-VNTSC-FAA-95-4, Final Report April 1995, National Technical Information Service, 5285 Port Royal Road, Springfield, VA 22161.
- *Windshear Training Aid*, U.S. Department of Transportation, Federal Aviation Administration, Boeing Commercial Airplane Group, National Technical Information Service, 5285 Port Royal Road, Springfield, VA 22161.





**A**

Academic Training Program, 1.2, 3.1–3.3  
 Accident statistics, 1.1, 2.2, 2.3  
 Aeronautical Information Manual, 2.4  
 Air temperature, 2.27, 2.34, 2.37  
 Air traffic control (ATC), 2.41  
 Airplane upset  
   causes, 1.1, 2.2–2.12, 3-A.3, 3-A.15  
   conditions, 1.1, 2.1  
   definition, 1.1, 2.1  
   frequency, 2.2  
   induced by environmental factors, 1.2, 2.3–2.8, 2.40, 3-A.3, 3-A.15, 3-B.4, 3-B.8–3-B.9, 3-B.16–3-B.17, 3-B.28  
   induced by human factors, 2.3  
   induced by pilots, 2.10–2.12, 3-A.3, 3-A.11  
   induced by systems anomalies, 2.8–2.10, 3-A.3, 3-A.13, 3-B.8, 3-B.17–3-B.19, 3-B.28  
   recovery from, 1.2, 2.12, 2.44, 3.7, 3-A.3, 3-A.5, 3-A.9, 3-A.11, 3-A.15, 3-A.19, 3-A.23, 3-A.25, 3-B.48, 3-B.56, 3-B.57  
   recovery team, 2.46  
 Angle of attack, 2.28–2.31, 2.34, 2.37, 2.40, 2.42–2.43, 2.46–2.49, 3.4–3.5, 3.14, 3.18–3.19, 3-A.3, 3-A.5, 3-A.7, 3-A.9, 3-A.17, 3-A.21, 3-A.23, 3-B.36–3-B.37, 3-B.39, 3-B.44, 3-B.47, 3-B.49–3-B.50, 3-B.52, 3-C.12, 3-C.15–3-C.16, 3-C.18, 3-C.24–3-C.25, 3-C.27, 3-D.1–3-D.11  
 Angle-of-attack indicator, 2.19  
 Angle of sideslip, 2.15–2.16, 2.24–2.26, 2.31, 3.4, 3-A.7, 3-A.21, 3-B.43, 3-B.51, 3-C.15, 3-D.1–2  
 Approved Flight Manual, 2.16, 2.17, 2.20, 2.21, 2.27, 3-A.5, 3-A.17, 3-B.37, 3-B.45  
 Attitude Direction Indicator (ADI), 2.38, 3.5, 3-B.57  
 Attitude Indicator, 2.19, 2.42–2.43, 3-C.22  
 Autoflight systems, 2.9, 3-B.21, 3-B.28  
 Automation, 2.9, 2.12, 3.1, 3.5, 3-A.3, 3-A.15, 3-B.23, 3-B.27–3-B.28, 3-C.9  
 Autopilot and autothrottle, 2.12, 2.47–2.49, 3.9, 3.11, 3.13, 3.14, 3.15, 3.17–3.19, 3.21–3.22, 3-A.3, 3-A.9, 3-A.15, 3-A.23, 3-B.65, 3-B.70–3-B.71, 3-B.75, 3-B.78, 3-B.82–3-B.83, 3-B.86–3-B.87, 3-C.22, 3-C.28, 3-C.31, 3-C.33

**B**

“Ball in a cup” model, 2.27  
 Bank angle, 1.1, 2.1, 2.16, 2.30, 2.33, 2.35, 2.37–2.38, 2.47–2.50, 3.9, 3.14–3.15, 3.17–3.19, 3.21–3.23, 3-A.7, 3-A.11, 3-A.19, 3-A.21, 3-A.25, 3-B.7, 3-B.44, 3-B.45, 3-B.48,

3-B.63, 3-B.75–3-B.82, 3-B.84, 3-B.86, 3-B.88, 3-C.19, 3-C.21, 3-C.27, 3-C.32–3-C.35

Bank Indicator, 2.45, 3.4, 3-A.9, 3-A.23, 3-B.57  
 Buffet boundaries, 2.35, 2.43, 3-B.45  
 Buffet Boundary charts, 2.39  
 Buffeting, 2.20, 2.35, 2.38, 2.40, 2.41, 2.47, 3-A.5, 3-A.9, 3-A.19, 3-A.23, 3-B.37, 3-B.45, 3-B.64, 3-C.24

**C**

Camber, 2.18, 2.21, 2.28, 3-B.38  
 Camber line, 2.21, 3-B.38  
 CD-ROM DOS format, 3.3  
 Controlled Flight Into Terrain (CFIT), 2.2  
 Chord line, 2.18–2.19, 2.21, 3-B.36, 3-B.38,  
 Control surfaces, 2.22, 2.30, 2.34, 3-B.39–3-B.40, 3-B.49, 3-B.53, 3-C.16–3-C.17  
 Counter-intuitive factors, 3.5, 3-B.58, 3-B.62  
 Crossover speed, 2.26, 3-B.44, 3-C.16  
 Crosswind landing, 2.25, 2.32–2.33, 3-B.51  
 Cruise Maneuver Capability charts, 2.35

**D**

Dihedral, 2.25, 2.33, 3-A.5, 3-A.17, 3-B.42, 3-B.43  
 Dihedral effect, 2.25, 2.35, 3-A.5, 3-A.17, 3-B.43  
 Dive speeds, 2.18  
 Dutch roll, 2.33, 3-A.11, 3-A.27, 3-B.51

**E**

Energy, 2.9, 2.13–2.14, 2.29, 2.31, 2.42, 2.44–2.45, 2.47–2.49, 3.4, 3.7, 3.11, 3.14, 3.17, 3.21, 3.23, 3-A.3, 3-A.9, 3-A.11, 3-A.15, 3-A.23, 3-A.25, 3-B.29–3-B.32, 3-B.50, 3-B.54–3-B.55, 3-B.57, 3-C.11–3-C.12, 3-C.28, 3-C.33  
 Energy management, 2.13, 2.42, 3-C.12, 3-C.33  
 Engine performance, 2.11, 2.46  
 Environmental factors, 1.2, 2.3, 3-A.3, 3-A.15, 3-B.4, 3-C.22

**F**

Field of view, 2.44  
 Flight envelope, 2.13, 2.17–2.18, 2.32, 2.34–2.35, 2.45, 3-B.25, 3-B.29, 3-B.35, 3-B.52, 3-B.55  
 Flight instruments, 2.9–2.11, 2.44, 3-B.18, 3-B.20, 3-B.23, 3-B.25–3-B.26, 3-B.28, 3-B.57, 3-D.1  
 Flight path angle, 2.19, 3-B.36  
 Fly-by-wire, 2.46–2.47, 3.9, 3-C.13, 3-C.20, 3-C.25



**G**

G force, 2.45, 2.48–2.49, 3.5, 3.17–3.19, 3-A.9, 3-A.23, 3-A.25, 3-B.50, 3-b.58, 3-B.60, 3-C.34

Graveyard Spiral, 2.30

Ground Training Program, 3.4

**H**

High Altitude Operations, App. 3-E.i

High Altitude Stall Warning, 3.23–3-25

**I**

Icing, 2.3, 2.8, 3-A.3, 3-A.15, 3-B.9, 3-B.17, 3-B.26, 3-B.28

Inattention, 2.10, 3-B.23, 3-B.25, 3-B.28, 3-C.28

Incapacitation, 2.10–2.11, 3-C.10

Instrument cross-check, 2.10, 2.11, 3-B.23, 3-B.24, 3-B.28

International Civil Aviation Organization (ICAO), 3.3, 3-D.1

**J**

Jet stream, 2.3–2.4, 2.43

**L**

Lateral control, 2.26, 2.31, 2.49, 3-B.50, 3-C.15, 3-C.16, 3-C.18

Lateral stability, 2.25, 3-A.5, 3-A.17, 3-B.42, 3-B.43

Load factors, 2.14–2.16, 2.20, 2.27, 2.43, 3-B.29, 3-B.33–3-B.25, 3-B.37, 3-B.55

Logitudinal axis, 2.19, 2.24, 2.29, 2.30–2.31, 3-A.3, 3-A.5, 3-A.17,

**M**

Mach number, 2.17, 2.21, 2.27, 2.33–2.34, 2.37, 2.39–2.40, 2.43, 3-A.5, 3-A.15, 3-A.17, 3-A.19, 3-B.36, 3-B.49, 3-C.15

Mach trim, 2.27

*Manual of Criteria for the Qualification of Flight Simulators*, 3.3, 3-D.1

Microburst, 2.3, 2.6, 3-A.3, 3-A.15, 3-B.9, 3-B.13, 3-B.15, 3-B.28

Moments, 2.7, 2.13, 2.23–2.26, 2.28, 2.30–2.32, 3.34, 3-A.5, 3-A.17, 3-B.30, 3-B.41–3-B.44, 3-B.47, 3-B.51, 3-B.53, 3-C.10, 3-C.14–3-C.15

**N**

NASA ASRS reports, 2.2

National Technical Information Service, 2.3, 2.7, 4.1

National Transportation Safety Board, 1.3, 2.2, 3-B.2

Newton's first law, 2.13, 3-B.30

Newton's second law, 2.14, 3-B.33, 3-B.48

**P**

Pilot Not Flying (PNF) instruments, 2.45, 3.23

Pitch angle, 2.13, 3-B.36, 3-C.12, 3-D.1

Pitch control, 2.28, 2.40, 2.49, 3.9, 3-B.64, 3-C.25

Pitching moments, 2.23–2.24, 2.28, 2.39, 3-B.41, 3-B.47, 3-C.14. *See also* moments

**R**

Roll, 2.1, 2.4, 2.7–2.13, 2.20, 2.22, 2.24–2.26, 2.30–2.33, 2.35–2.36, 2.40–2.43, 2.47–2.50, 3.4, 3.7–3.9, 3.13–3.14, 3.17–3.19, 3.21–3.22, 3-A.5, 3-A.7, 3-A.9, 3-A.11, 3-A.19, 3-A.21, 3-A.23, 3-A.25, 3-A.27, 3-B.7, 3-B.42–3-B.44, 3-B.49–3-B.51, 3-B.64–3-B.67, 3-B.69, 3-B.75, 3-B.77–3-B.78, 3-B.80, 3-B.82, 3-B.84–3-B.86, 3-B.88, 3-B.14–3-C.16, 3-B.18–3-B.19, 3-B.24, 3-B.27–3-B.29, 3-B.32–3-B.35, 3-D.1–3-D.2

Rudder, 2.25–2.27, 2.30–2.33, 2.46–2.49, 3.8–3.9, 3.21–3.22, 3-A.5, 3-A.7, 3-A.11, 3-A.13, 3-A.17, 3-A.21, 3-A.25, 3-A.27, 3-B.43–3-B.34, 3-B.51, 3-B.60, 3-C.13–3-C.16, 3-C.18–3-C.19, 3-C.23, 3-C.27–3-C.28, 3-C.34

Rudder trim, 2.33, 3-A.11, 3-A.27,

**S**

Sideslip, 2.15, 2.16, 2.24–2.26, 2.31–2.33, 2.46, 3.4–3.5, 3.9, 3-A.5, 3-A.7, 3-A.9, 3-A.11, 3-A.17, 3-A.19, 3-A.21, 3-A.25, 3-A.27, 3-B.34, 3-B.42–3-B.44, 3-B.51, 3-C.14–3-C.16, 3-C.18, 3-D.1–3-D.11

angle. *See* angle of sideslip

pilot-commanded, 2.25–2.26, 3-B.42, 3-B.44,

Simulator, 1.1–1.3, 2.1, 2.40, 2.45, 3.1–3.5, 3.7, 3.11, 3.13–3.14, 3.17–3.19, 3.21, 3.23, 3-B.58, 3-C.8–3-C.10, 3-C.15, 3-C.17, 3-C.21–3-C.22, 3-C.26, 3-C.28, 3-C.33, 3-D.1–11

Simulator limitations, 3.3

Simulator Training Program, 1.2, 3.1, 3.3–3.5

Situation awareness, 2.44

Slip-skid indicator, 2.26

Spatial disorientation, 2.11

Speed margins, 2.35, 3-B.23, 3-B.26, 3-B.28, 3-C.21

Speed stability, 2.27, 3-B.45  
 Speedbrakes, 2.22, 2.37, 2.42, 3.9, 3.18–3.19,  
 3-B.54, 3-C.13, 3-C.24, 3-C.30  
 Spoilers, 2.22, 2.24, 2.26–2.27, 2.32, 2.34, 2.41–  
 2.42, 3.9, 3-A.5, 3-A.19, 3-B.40, 3-B.44,  
 3-B.49, 3-C.9, 3-C.15–3-C.16, 3-C.27  
 Stall, 2.1, 2.3, 2.9, 2.12–2.23, 2.25–2.27, 2.30–  
 2.49, 3.1, 3.4, 3.7, 3.9, 3.14, 3.17–3.19,  
 3.22, 3-A.3, 3-A.5, 3-A.7, 3-A.9, 3-A.15,  
 3-A.17, 3-A.19, 3-A.23, 3-B.32, 3-B.35–  
 3-B.37, 3-B.39–3-B.40, 3-B.49, 3-B.52,  
 3-B.55, 3-B.61–3-B.62, 3-B.64, 3-B.70,  
 3-B.72, 3-B.86, 3-B.87, 3-C.12, 3-C.17–  
 3-C.19, 3-C.24–3-C.25, 3-C.30–3-C.33,  
 3-C.35, 3-D.1–3-D.2  
 Stall warning, 2.9, 2.20–2.21, 2.40–2.41, 3-A.9,  
 3-A.23, 3-B.37, 3-C.24, 3-C.30  
 Standby Attitude Indicator, 2.38  
 Startle factor, 2.38, 3-B.58–3-B.59  
 Static stability, 2.28, 3-A.5, 3-A.19, 3-B.46,  
 3-C.13

## T

Thunderstorms, 2.4–2.6, 3-B.9, 3-B.11, 3-B.13–  
 3-B.15, 3-B.28, 3-C.8  
 Trim, 2.9, 2.12, 2.20, 2.23–2.24, 2.27–2.28,  
 2.33–2.34, 2.41, 2.47–2.50, 3.3, 3.9, 3.13–  
 3.15, 3.17–3.19, 3-A.11, 3-A.25, 3-A.27,  
 3-B.41, 3-B.46, 3-B.52, 3-B.66, 3-B.70,  
 3-B.73, 3-B.78, 3-B.81, 3-B.86, 3-B.89,  
 3-C.13, 3-C.24, 3-C.26, 3-C.30, 3-C.32,  
 3-C.35  
*Turbulence Education and Training Aid*, 2.3, 4.1  
 Turbulence, 2.3  
   clear air turbulence (CAT), 2.3–2.4,  
   3-B.11, 3-B.28  
   extreme, 2.3–2.4, 3-A.11, 3-A.25, 3-B.25,  
   3-B.48, 3-C.20  
   light, 2.3–2.4  
   mechanical, 2.4  
   microburst, 2.3, 2.6  
   moderate, 2.3–2.4  
   mountain wave, 2.4, 3-B.9, 3-B.12, 3-B.28,  
   3-C.8  
   severe, 2.3–2.4, 3-B.12, 3-C.8  
   thunderstorms, 2.4–2.6, 3-B.9, 3-B.11  
   wake turbulence, 2.6–2.8, 3-A.3, 3-A.13  
 Turning, 2.27, 2.29–2.30, 2.36, 2.41–2.43,  
 2.48–2.49, 3-B.48, 3-C.37

## V

Vertical Speed Indicator (VSI), 2.19, 2.45  
 Vortices, 2.6, 2.7

## W

*Wake Turbulence Training Aid*, 2.7, 4.1  
 Wake vortices, 3-B.15, 3-C.7  
*Windshear Training Aid*, 2.4, 4.1  
 Windshear, 2.3–2.5, 2.33, 2.41, 3-A.3, 3-A.15,  
 3-B.9–3-B.10, 3-B.13, 3-B.28, 3-C.7, 4.1  
 Wing sweep, 2.25, 3-A.5, 3-A.17, 3-B.43

## Y

Yaw, 2.1, 2.4, 2.24, 2.26, 2.30–2.33, 2.44, 3.9,  
 3.21, 3-A.5, 3-A.7, 3-A.11, 3-A.19, 3-A.21,  
 3-A.27, 3-B.7, 3-B.49, 3-B.51, 3-C.9,  
 3-C.12–3-C.18, 3-D.1  
 Yaw damper, 2.26, 2.30, 2.33, 3-A.7, 3-A.11,  
 3-A.21, 3-A.27, 3-C.9,

