



INSTALLATION MANUAL
PosiStrobe Titania

DOC.NO:AVE-PSPSYW-IM

Table of Contents

PART 0	MANUAL ADMINISTRATION.....	3
0.1	DOCUMENT APPROVAL.....	3
0.2	AMENDMENT RECORD PROCEDURE.....	4
0.3	EFFECTED PAGES PROCEDURE.....	4
1.	POSISTROBE TITANIA.....	5
2.	OPERATING INSTRUCTIONS.....	5
3.	INSTALLATION SCHEMATIC / WIRING DIAGRAM.....	5
4.	CONTROL & POWER INPUTS.....	6
5.	TECHNICAL SPECIFICATION.....	6
6.	TECHNICAL DRAWING.....	7
7.	WIRING CHART.....	8
8.	OPTICAL PERFORMANCE.....	9
9.	EQUIPMENT LIMITATION.....	10
10.	CARE AND CLEANING OF YOUR AVEO ENGINEERING AVIATION LIGHTS.....	10
11.	TESTING OF THE LIGHT BEFORE INSTALLATION.....	10
12.	NOTES ON INSTALLATION.....	11

Part 0 Manual Administration

0.1 Document approval

This document has been established in accordance with an alternative procedure to DOA approved under EASA AP429.

This installation manual is applicable for part numbers:

- PosiStrobe Titania **AVE-PSPSYW-T01**

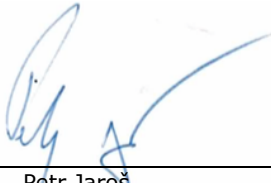
Compiled by:  _____ 28. – Aug. - 2018
Petr Jaros
Engineer, Aveo Engineering Group, s.r.o.

Approved by:  _____ 28. – Aug. - 2018
Georg Hartl
Head of DO, Aveo Engineering Group, s.r.o.

0.2 Amendment Record procedure

The master copy of this document shall be kept electronically as a read only document under the control of Aveo Engineering Group, s.r.o. as Master Copy.

ALL amendments to this manual will initiate a raise of issue.

ALL raises of issue will be given a sequential Alphabetic Issue Ident sequentially from 01 to 99 in Table 01 - **Issue No:** Column- Initial Issue of Document will be **"01"**

ALL Issues of this document will be approved by Head of DO

Issue No.	Details	Date	Effected Pages
01	Initial Issue	28.Aug.2018	ALL
Table 01: Document Amendment Record Table			

0.3 Effected Pages Procedure

ALL pages affected by ANY raise of issue of this manual will be listed in Table 01 - *Effected Pages* Column.

The reason(s) for ALL raise of issue and description of change due to raise of issue will be provided for ALL raises of issue in Table 01 - *Details* Column.

Changes from the previous issue are highlighted by **YELLOW HIGHLIGHTING** over new content. AND **YELLOW HIGHLIGHTING** AND **CROSSING OUT** of deleted content.

Example (~~CROSSING OUT~~)

1. PosiStrobe Titania

PosiStrobe Titania™ is the minimum EMI signature tail position and strobe light for the aviation industry. This light provides performance much above the required position and strobe per TSO standards.

2. OPERATING INSTRUCTIONS

When installed on the aircraft, using the aircraft's power (14 or 28 volts), the light will be at its maximum intensity. *Operating Voltage range is 9-36VDC.*

3. INSTALLATION SCHEMATIC / WIRING DIAGRAM

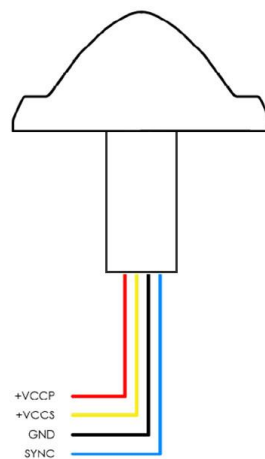

Wire type: multicores 22AWG, 600V insulation, 200°C rating;
Wire length: 12" minimum (310mm minimum)

4. CONTROL & POWER INPUTS

P/N: AVE-PSPSYW-T01

Pos/Strobe:

Red	+14V / +28V, Nav/Pos
Yellow	+14V / +28V, Anti-collision
Black	Common 28 return VRTN
Blue	Synchronization

5. TECHNICAL SPECIFICATION

Dimensions:	56 mm x 45 mm 2.19" x 1.77"
Height:	
Outside A/C skin	33 mm (1.30")
Inside A/C	30 mm (1.18")
Operating Voltage Range:	9 - 36 Vdc
Weight:	98 g (+/- 5g) 0.216 lb (+/- 0.18)
Output power:	
– position (white steady)	4.1 W
– white strobe:	41.3 W
Input power (at 25°C and 85% DC-DC efficiency, @28VDC):	
– position (white steady)	6.2 W
– white strobe:	53 W
Input current:	
– position - white:	0.22 A
– white strobe:	1.9 A
Repetition Flash Rate of Strobe:	48 cycles per minute
Warm up time:	not more than 20s
Low temperature slope start:	not more than 60s
Ambient temperature:	-55 °C..+85°C
Overheat protection:	+85°C
Voltage protection:	
a. Transcend voltage:	60V, both polarities
b. Under-voltage lockout:	9V , not more
c. Over-voltage lockout:	36V, not less

6. TECHNICAL DRAWING

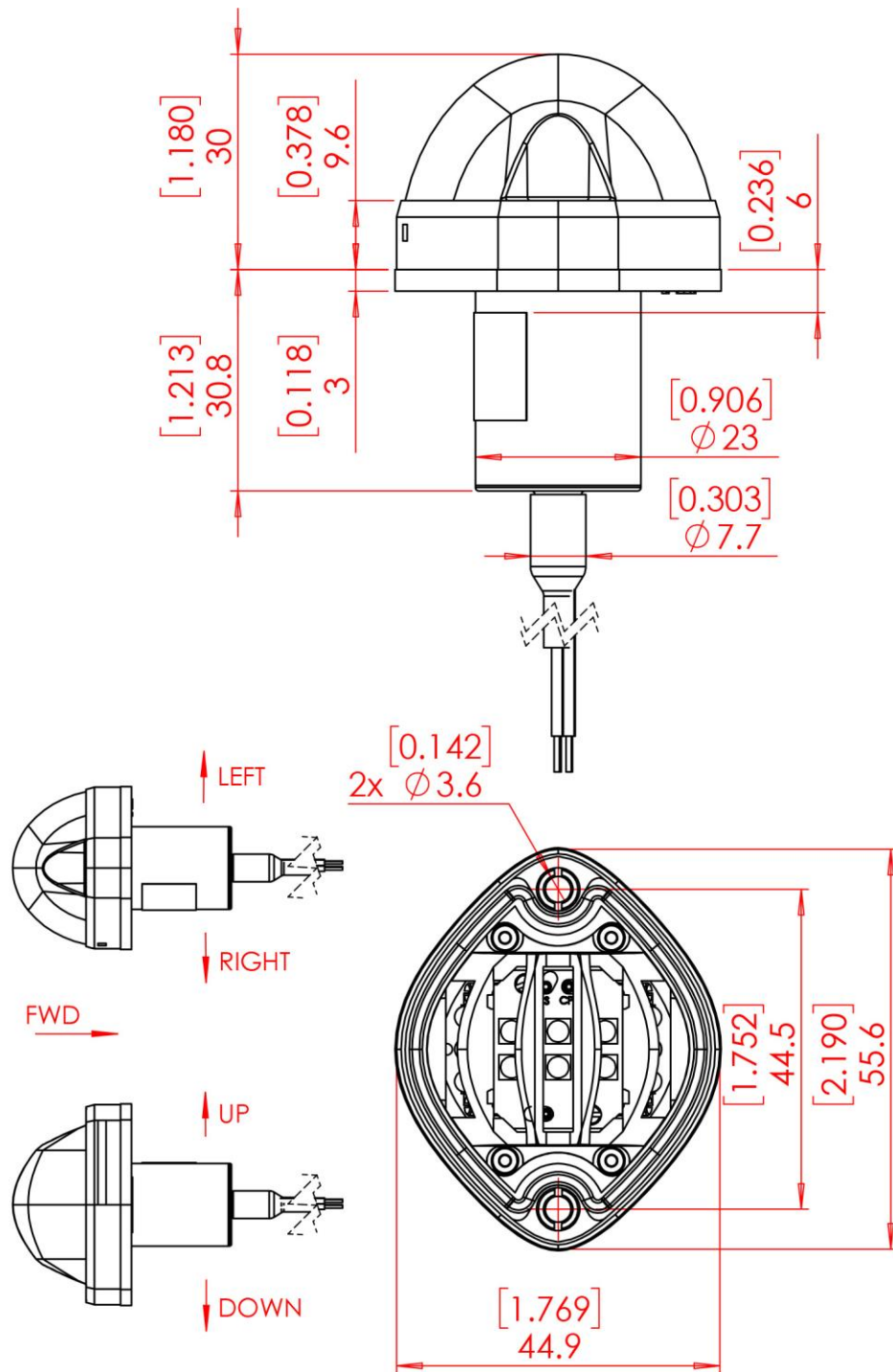

*dimensions in mm [inches]

7. WIRING CHART

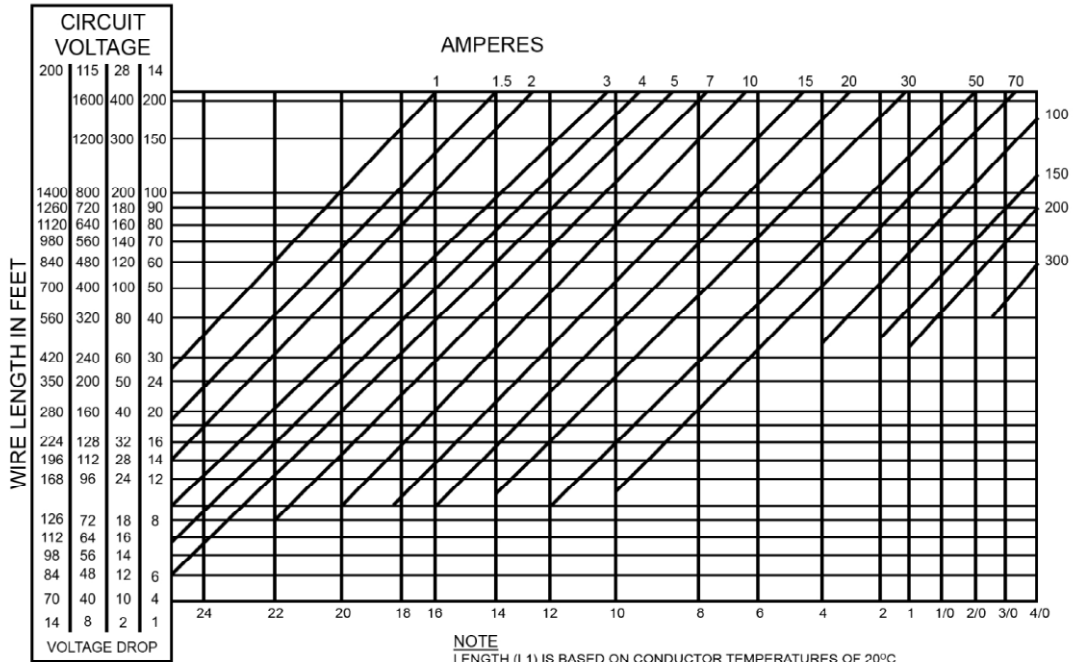

NOTE
LENGTH (L1) IS BASED ON CONDUCTOR TEMPERATURES OF 20°C
TO DETERMINE LENGTH (L2) AT HIGHER CONDUCTOR TEMPERATURE USE FORMULA
WHERE T2 - ESTIMATED CONDUCTOR TEMPERATURE °C

WIRE SIZE

VOLTAGE DROP CHART
INTERMITTENT FLOW AT 20°
TIN-PLATED MIL-W-27759
CONDUCTOR

8. OPTICAL PERFORMANCE

POSITION LIGHT

Test performed at 28V. Polar coordinates, 0° is forward direction.

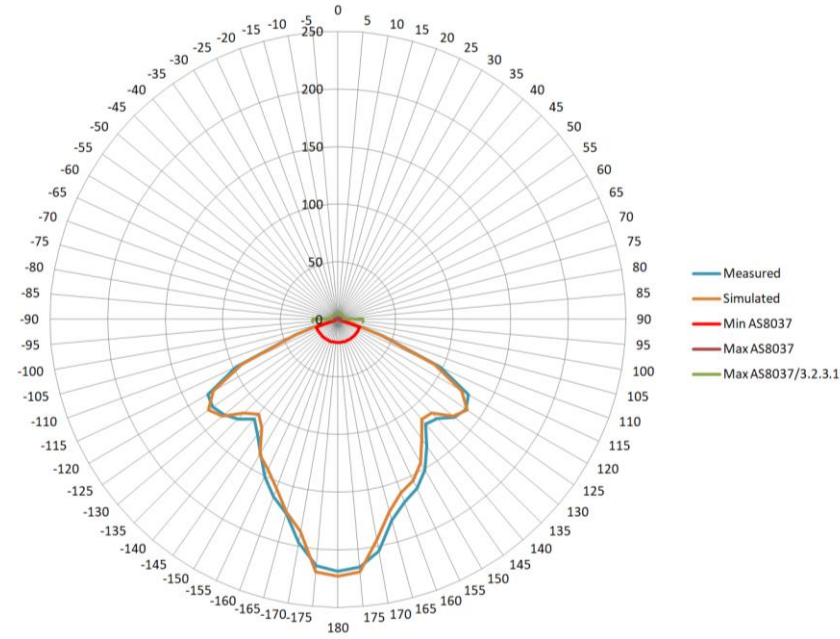

Position H/V0. Full range 0-250cd

STROBE LIGHT

Test performed at 28V. Vertical plane at 180° horizontal point (rear). Effective candelas.

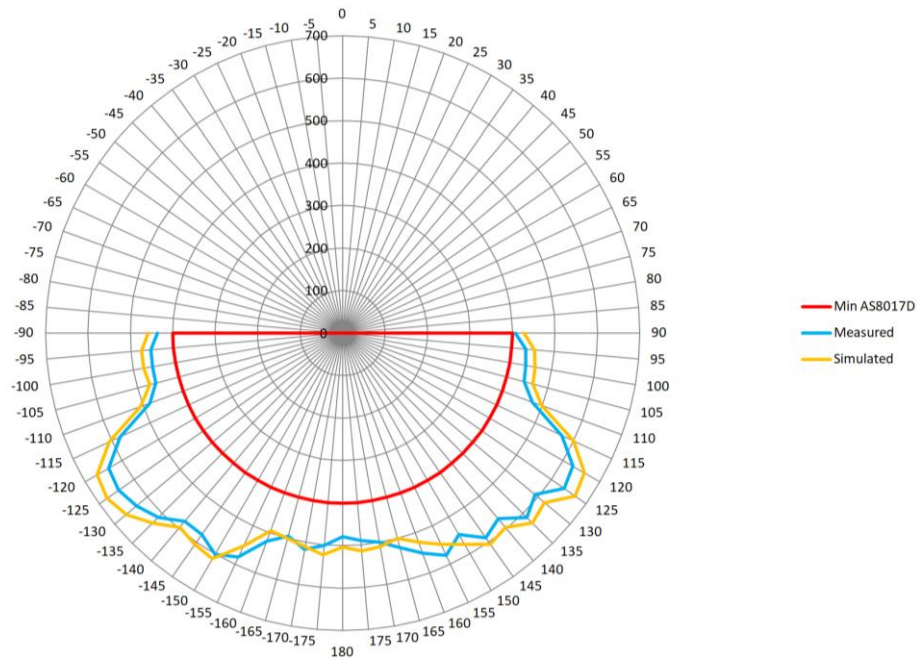

Anti-collision H/V0. Full range 0-700cd

9. EQUIPMENT LIMITATION

PosiStrobe should only be powered by 9-36VDC.

10. CARE AND CLEANING OF YOUR AVEO ENGINEERING AVIATION LIGHTS

When you receive your Aveo Engineering Aviation Lights, they will have been factory polished and ready to install on the aircraft.

If the lights require a deeper cleaning, they should be polished with a quality lamb's wool sheet and can also be used for deeper polishing. Under no circumstances should any petroleum based product be used to clean the lights.

11. TESTING OF THE LIGHT BEFORE INSTALLATION

All Aveo Aviation lights undergo rigorous testing prior to being released from our engineering manufacturing department. This testing involves a burn-in time as well as other function testing. No light is released for sale without undergoing this extensive operational testing.

When you receive the **PosiStrobe** light, and wish to test the function of the light prior to installation on your aircraft, please note the following:

1. Please review the written information that is enclosed in the packaging. Warranty information as well as a cautionary note about power supply removal is enclosed with each package.
2. Remove the light from the package.

Red	+14V / +28V, Nav/Pos
Yellow	+14V / +28V, Anti-collision
Black	Common 28 return VRTN
Blue	Synchronization

3. Testing of the function of the light can be done with a regular 28V/5A dc power supply (not a battery charger).

Pos/strobe:

Connect the black wire to the ground (negative) leads of a power supply, then connect the yellow or red wire to the positive (+) leads on the power supply. The light should start flashing (yellow wire = anti-collision light) or lighting (red wire = white steady). Connecting the blue wires from each Aveo light together (and not to the ground or positive terminals on the battery) should show that the lights are flashing together and indicates the synchronization feature is working properly.

IMPORTANT NOTES:

1. Under no circumstances should any power supply other than a 9-36 VDC, or a 28 volt battery be used to test the light. Do not use: Battery chargers, battery back-up power devices, or other bench avionics testing methods to test the aviation light. The light is functional between 9 and 36 volts. Use of a battery charger or other power unit to test the light will void the warranty and may damage the light.

If you have any questions about the installation of the lights, please refer to our web site: www.aveoengineering.com

12. NOTES ON INSTALLATION

Please use screw M3 (DIN912) or SHCS #6-32 or equivalent mounting screw for the installation. Spread the tightening forces evenly around the mounting hole. Stainless steel screw is recommended. Length depends upon placement location on aircraft.