



## T2000 ADSB TRANSPONDER



## INSTALLATION MANUAL

Microair Avionics Pty Ltd

ACN 646 664 459  
601 Curtin Ave East  
Pinkenba QLD 4008  
Australia

Phone: +61 7 4160 8200  
Email: support@microair.aero  
sales@microair.aero  
Web: www.microair.aero

## About This Document

Microair Avionics has developed the T2000ADSB transponder to provide for aircraft surveillance requirements of ATCRBS Mode 3A/C with ADS-B.

This is a controlled document, and may not be copied, amended, or distributed without the prior consent of Microair Avionics Pty Ltd.

© Microair Avionics Pty Ltd



## DOCUMENT REVISION STATUS

Revision	Date	Change
01R1	21/02/23	Initial Release
01R2	24/03/23	Minor correction. Programming moved from User manual. Extended test and calibration section from user feedback.

## **TABLE OF CONTENTS**

<b>1.0</b>	<b>INTRODUCTION</b>	<b>4</b>
<b>2.0</b>	<b>PANEL MOUNTING</b>	<b>5</b>
<b>3.0</b>	<b>ALTITUDE ENCODER</b>	<b>6</b>
<b>4.0</b>	<b>TRANSPONDER ANTENNA &amp; COAX CABLE</b>	<b>7</b>
4.1	MOUNTING	7
4.2	GROUND PLANE	7
4.3	COAXIAL CABLE	7
<b>5.0</b>	<b>GPS ANTENNA</b>	<b>9</b>
5.1	DASH MOUNTED ANTENNA	9
5.2	EXTERNAL MOUNTED ANTENNA	9
<b>6.0</b>	<b>WIRING</b>	<b>10</b>
6.1	GENERAL WIRING	10
6.2	AUDIO BEEP	11
6.3	SUPPRESSION IN	11
6.4	SUPPRESSION OUT	11
6.5	AIR/GND (PREVIOUSLY KNOWN AS EXTERNAL STANDBY)	11
6.6	EXTERNAL IDENT	11
<b>7.0</b>	<b>INITIALISATION AND SETUP</b>	<b>12</b>
7.1	PROGRAM MODE	12
7.2	VFR CODE	12
7.3	ICAO CODE	13
7.4	EMITTER CATEGORY	13
7.5	AIRCRAFT ID	14
7.6	ENCODER SOURCE	14
7.7	ALTITUDE UNIT	15
7.8	BAROMETER UNIT (MB OR INHG)	15
7.9	AIR GROUND LOGIC	15
7.10	ADSB VERSION	16
7.11	EXIT PROGRAM	16
<b>8.0</b>	<b>CALIBRATION &amp; TESTING OF INSTALLATION</b>	<b>17</b>
8.1	IFR6000 TEST PROCEDURE	17
8.2	ADSB TEST PROCEDURE	18
8.3	BACKGROUND INFORMATION ON INTEGRITY	19
8.3.1	INTEGRITY NUC	19
8.3.2	ACCURACY NAC	20
8.3.3	INTEGRITY SIL	20
<b>9.0</b>	<b>WIRING DIAGRAMS</b>	<b>21</b>
<b>10.0</b>	<b>INSTALLATION DIMENSIONS</b>	<b>29</b>
<b>11.0</b>	<b>PIN ASSIGNMENTS</b>	<b>30</b>
<b>12.0</b>	<b>PANEL TEMPLATE</b>	<b>31</b>
<b>13.0</b>	<b>SPECIFICATIONS</b>	<b>32</b>

## 1.0 INTRODUCTION

Microair recommends you familiarise yourself with this Installation Manual **BEFORE** you start installing your Microair T2000ADSB Transponder.



### IMPORTANT NOTE

*The T2000ADSB must be installed and tested by a suitably qualified and authorised Avionics mechanic and all structural changes, such as the GPS antenna installation, must be approved by a suitably qualified and authorised engineer or the aircrafts manufacturer.*

*The installer is responsible for ensuring that the installation meets all functional and regulatory requirements. If the T2000ADSB is installed by an aircraft owner, who has the appropriate authority to do so, they remain responsible for the ensuring the installation meets all functional and regulatory requirements.*

*Microair strongly recommends the use of an ADSB/Transponder test set such as the IFR6000 to validate the installation. Microair had an IFR6000 available for lease on a day rate basis.*

*If ADSB test equipment is not available then Microair recommends that as a minimum, a structured test flight is conducted with a detailed log maintained during the flight which can then be compared to the Flight Track Log from an ADSB tracking provider such as [FlightAware](#) or [Flightradar24](#). We recommend that the flight log, the downloaded flight track and the comparison are filed in the aircrafts records as demonstration of a compliant installation.*

## 2.0 PANEL MOUNTING

Determine a suitable location in the instrument panel in full view of both pilots. Cut a 57mm diameter (2 ¼ inch) hole with 4 x 4mm holes for the mounting screws. Dimensions for this are provided on the panel template. Allow a minimum of 63mm (2 ½ inch) square behind the cut out, to allow clearance from other instruments. A depth of 200mm (8 inches) is recommended to accommodate the transponder and electrical connectors.

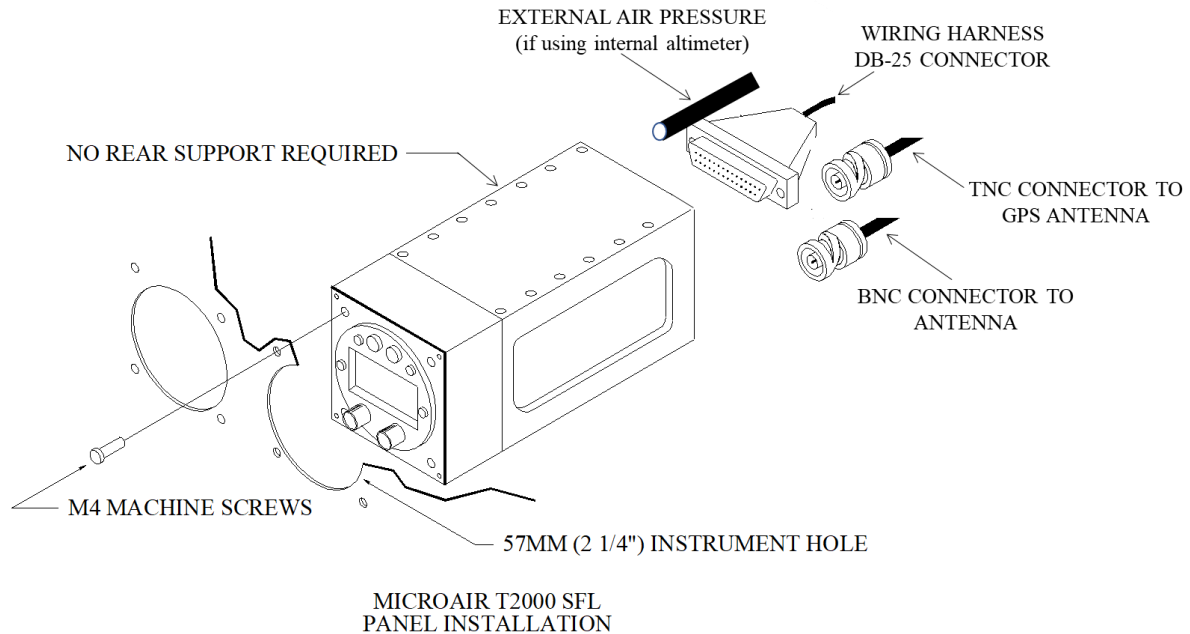

The T2000ADSB weighs only 685g (24oz). The four M4 x 12mm machine screws are sufficient to support the transponder. No rear support is required unless the panel structure itself is too weak to support the load.

### IMPORTANT NOTE

*Removal of the chassis screws for the purpose of attaching support bracket is not permitted.*

*The drilling of holes in the chassis for any purpose is not permitted.*

*Filings from changing the thread of the M4 screw may cause electrical faults. Faults of this type are NOT covered by warranty.*



### 3.0 ALTITUDE ENCODER

The T2000ADSB has three options for its altitude source:

1. An inbuilt altimeter that requires no connection to an external altimeter, mode C blind encoder or other EFIS system for its altitude data input. If using the inbuilt altimeter, connect the External Air Pressure static source directly to the 1/8" NPT male input on the rear side of the transponder and select the appropriate Encoder Source from the Program Mode user menu.
2. A Gillham encoded external altimeter or mode C blind encoder.
3. A serial encoded external mode C blind encoder or EFIS system.

For customers intending to use an installed altimeter, mode C blind encoder or other EFIS altitude source (either Gilham or serial) ensure installation is per the manufacturer's instructions and select the appropriate Encoder Source from the Program Mode user menu. An appropriate wiring harness is connected to the T2000ADSB via a DB25 connector (refer wiring diagram). The power for blind mode C encoders can be supplied from the T2000ADSB and is equal to the aircraft supply voltage. This power is switched when the T2000ADSB is turned on.

If the encoder is to be powered separately, it is recommended that a ground wire is run between the encoder and T2000ADSB to ensure correct switching of the data lines.



#### IMPORTANT NOTE

*Most encoder manufacturers advise of a warm up period for their product before altitude data is supplied. The period can typically be up to 10 minutes. For the Microair EC2002, the warm up time is only 10 seconds!*

Refer to WIRING DIAGRAMS (section 9.0) for wiring details and pin assignments for commonly used altitude encoders or EFIS, in both Gillham and serial data outputs.



#### IMPORTANT NOTE

*If the aircraft voltage is 28V and the encoder is 14V only, a 28/14V converter should be installed between the T2000ADSB and the encoder.*

*Please ensure that the voltage supply line to power the encoder is NOT shorted to any data line or ground. The T2000ADSB will incur internal faults if a short occurs. This type of damage is NOT covered by the warranty.*

## 4.0 TRANSPONDER ANTENNA & COAX CABLE

The T2000ADS B requires an antenna tuned to 1090MHz.

### 4.1 Mounting

The transponder signal is primarily directed to ground stations (Radar sites), hence the antenna is typically located on the underside of the fuselage. The position should give the antenna a full 360-degree view of the horizon. The position should be away from other protrusions from the airframe, such as footsteps, and undercarriage legs.

To avoid possible interference the antenna must be mounted a minimum of 0.3m (12 inches) away from the **T2000ADS B**. The transponder antenna outputs high levels of RF energy and should be located at least 1m (3ft) away from vulnerable part of the human body or be separated by a metal panel.

If the VHF comm antenna is already located on the underside of the fuselage, the transponder antenna should be located at least 1 metre (3ft) away. The transponder antenna should be mounted 2 metres (78 inches) from a **DME** antenna, and 1.5 metres (58 inches) from the **ADF** sense antenna.

### 4.2 Ground Plane

In metal skin aircraft the skin forms the ground plane. To ensure a good electrical connection, it may be necessary to remove paint/primer from the inside face of the skin, before attaching the antenna. This may be resealed after the antenna is installed. On pressurised aircraft, the antenna should be sealed using RTV-3145 or equivalent, to seal around the connector and mounting hardware. All antenna mounts should be sealed around the outside for moisture protection, using RTV-3145 or equivalent.

In a composite aircraft the skin of the airframe cannot be used, and a suitable ground plane must be fabricated. The ground plane is typically an aluminium disc with a radius equal to the height of the antenna (approx. 75mm or 3”). The antenna is mounted in the centre of the ground plane.

The ground plane does not have to be circular however, but the area should be approx the same size. Fibreglass aircraft can mount the ground plane on the inside of the aircraft.

Although carbon fibre is a good reflector of RF, it is not a suitable material for a ground plane. A metal ground plane is ideal.

It is important to ensure that a good electrical contact is established, as some antennas have sealing O-rings which can isolate this connection.



### 4.3 Coaxial Cable

The T2000ADS B allows for 2dB cable loss from the unit to the antenna. The installer should consider carefully what type of coaxial cable is to be used, so that this loss limit is not exceeded. The cable should be terminated with a crimped BNC connector rated for 200W<sub>pep</sub> and 2GHz such as the Amphenol 112514.

Microair recommends the use of RG400 coax cable in accordance with the table below.

Cable	Bending Radius	Loss @ 1Ghz dB/m	Max Length	TX Power	RX Sensitivity
RG400 (Mil Spec)	50mm (2")	0.485dB/m	3.9m 12.8ft	> 125W	< -69dBm



**IMPORTANT NOTE**

*Do not exceed the minimum bending radius. Tight bends will introduce losses in the cable, which may affect the performance of the transponder.*

*When fixing the coax cable in the airframe, do not “strangle” the cable with tight cable ties. This can distort or damage the coax screen.*

*Avoid looping excess Coax cable. It is recommended that a coax cable correct to within 300mm (1ft) be ordered (available at [microair.aero](http://microair.aero)). If shortening a coax cable pay particular attention to the termination. A crimped connector rated for operation up to 2GHz and 200W is required such as the 112514 BNC Connector.*



## 5.0 GPS ANTENNA

The T2000ADSB requires the installation of a GPS Antenna to receive a satellite GPS signal required by the unit. The GPS Antenna is connected to the T2000ADSB on the back of the unit via TNC connection. Two types of GPS Antennas are recommended for operation with the T2000ADSB transponder.

### 5.1 Dash Mounted Antenna

For composite skinned aircraft, a dash-mounted GPS antenna can be connected to the unit and positioned on the instrument dashboard in an unobstructed position. Maintain separation of the GPS antenna from other antennas located on the dashboard should these be present.

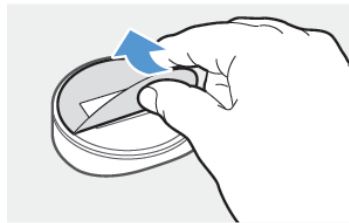

The Microair dash mounted antenna uses an adhesive pad to secure the antenna to the dash. Peel the label from the adhesive backing of the GPS antenna and firmly press the antenna into position on top of the instrument panel.

Other GPS dash mounted antennas may require a physical fixture to be installed on the dash. Ensure to follow the manufacturer's instructions for the installation of your dash mounted GPS antenna in such instances.



#### IMPORTANT NOTE

**A magnetic fixing solution is not recommended for the GPS antenna as this may interfere with other instrumentation present.**

### 5.2 External Mounted Antenna

For metallic skinned aircraft, it is recommended that a TSO'd externally mounted antenna is used. Position the GPS antenna on the upper side of the fuselage in an unobstructed position, preferably at the highest point of the aircraft when in level flight. To the extent practicable, mount the antenna so that the base is horizontal when the aircraft is in cruise attitude. Route the antenna cable in the most direct path practicable and reduce the cable length to the minimum required.

Ensure to follow the manufacturer's instructions for the installation of the Externally mounted antenna.



#### IMPORTANT NOTE

**Avoid looping excess Coax cable. It is recommended that a coax cable correct to within 300mm (1ft) be ordered (available at [microair.aero](http://microair.aero)). If shortening a coax cable pay particular attention to the termination. A crimped connector rated for operation up to 2GHz is required such as the Amphenol 122372 (straight) or 122365 (right angle) TNC connector.**

## 6.0 WIRING

The T2000ADSB must be installed with a wiring harness which meets the following requirements.

### 6.1 General Wiring

The T2000ADSB is to be powered from the aircraft supply, via the avionics master and fuse/circuit breaker with a **maximum** 5 amp rating (3 amp minimum).



**IMPORTANT NOTE**

**The aircraft's electrical system may produce severe transient voltages during engine start and stop**

**Microair recommends that the avionics master be turned off during engine start and stop, to prevent damage occurring to the T2000ADSB.**

**Damage to the transponder as a result of transient voltages is NOT covered by the warranty.**

Microair recommends that if used, the external encoder be installed and wired in accordance with the manufacturer's installation instructions. The encoder can be powered directly from the T2000ADSB.

It is very important to secure all D series plugs via their security screws before operation. Aircraft vibration may disconnect a D series plug if it not secured. Wiring is to be separated from the coaxial cables.

Microair recommends the following wire types for connection of the T2000ADSB:

Power Input	18 AWG TEFZEL 22759/16-16	Red and Black Wire
External Connections	22 AWG TEFZEL 22759/16-22 22 AWG TEFZEL 27500-22TG1T14	Wire or Single core shielded
Encoder Power	22 AWG TEFZEL 22759/16-22	Red and Black Wire
Encoder Data	22 AWG TEFZEL 22759/16-22	White Wire

To ensure correct installation and to make future service simple, Microair recommends that all wiring be labelled for easy identification.

## 6.2 Audio Beep

The T2000ADSB beep function when set to ON, will emit a beep tone on this line. Audio beep should be taken to the Auxiliary input of the aircraft's radio or Audio Panel.

When connecting the beep function to the Microair M760 transceiver, simply join the beep line directly to any headphone line (orange wire in factory supplied harness).

## 6.3 Suppression IN

The suppression IN line is used in installations with multiple transponders or DME systems to "suppress" the T2000ADSB, to prevent concurrent transmissions, and interference. When another system transmits, it will send a positive voltage to the suppression IN, which prevents the T2000ADSB from transmitting.

The T2000ADSB requires a minimum signal voltage of 5V. The signal voltage may not exceed 20V.

In most installations the Suppression IN can be left unconnected.

## 6.4 Suppression OUT

Where the T2000ADSB is used in installations with multiple transponders or DME systems, the suppression OUT line is used to "suppress" other transponder and DME equipment installed in the aircraft, from interfering. When the T2000ADSB transmits, it raises a positive voltage on the suppression OUT line, which prevents the other equipment from transmitting.

The signal voltage is 5V.

In most installations the Suppression IN can be left unconnected.

## 6.5 AIR/GND (previously known as External Standby)

The T2000ADSB must know its airborne or surface status and provides two methods to achieve this:

1. An external switch can be wired to the T2000ADSB. This is usually a "Squat Switch" on the undercarriage or an "Air Switch" on the wings leading edge. The switch must pull the T2000ADSB input to ground when active but the T2000ADSB can be set for the active state to either be Surface (NORM) or Airborne (REV). Refer to Program Mode described below.
2. GPS speed can also be used to switch between Airborne and Surface modes. Ground speeds above 35kts will cause the T2000ADSB to switch to Airborne Mode whilst ground speeds below 20kts will cause the T2000ADSB to switch to Surface Mode.

## 6.6 External Ident

This line is typically wired to a momentary-ON switch, in a position more easily reached by the pilot / co-pilot (e.g. control column). When this line is taken to ground briefly, the T2000ADSB will go through its Ident function.

Most installations do not include an External Ident switch.



### IMPORTANT NOTE

*If any of the above wiring functions are not required, they can simply be left unwired.*

## 7.0 INITIALISATION AND SETUP

On initial power up the T2000ADSB will enter Program Mode to allow the ICAO Code (sometimes call the Mode S code) to be set. It is important that the Emitter Category and Aircraft ID are also set.

- If the ICAO Code and aircraft Registration were provided to Microair at the time of purchase then this data may have been preset.

The following procedures provide step by step instructions to program the transponder options.

<b>PROGRAM MODE</b>	<b>VFR CODE</b>
	<b>ICAO CODE</b>
	<b>EMISSION CATEGORY</b>
	<b>AIRCRAFT ID</b>
	<b>ENCODER SOURCE</b>
	<b>ALTITUDE UNIT (ft/m)</b>
	<b>BAROMETER UNIT (Mb/inHg)</b>
	<b>AIR GROUND LOGIC</b>
	<b>ADSB VERSION</b>
	<b>EXIT PROGRAM</b>

### 7.1 PROGRAM MODE

To start the **T2000ADSB** in **PROGRAM MODE**, hold down the **MODE** key whilst powering the device. Keep the **MODE** key held down until the start up self test messages have been displayed.

Each item can be adjusted to the desired value or option by scrolling the **CODE SELECT** knob. The selected value or option can be saved by pressing the **ENTER** key. **PROGRAM MODE** then moves to the next menu item.

NOTE: If the ICAO code is not set the T2000ADSB will always start in **PROGRAM MODE** as ADSB cannot operate without a valid code.



### 7.2 VFR CODE

This item sets the default **VFR** code which can be hot key accessed from the **V** (VFR) key. For most countries the default general aviation code is **1200**.



Press <b>ENTER</b> key	Until <b>VFR CODE</b> message appears
Rotate <b>CODE SELECT</b> knob	Adjust the digit highlighted by the cursor.
Press <b>CODE SELECT</b> knob	Moves the digit to the right
Press <b>ENTER</b> key	The message <b>SAVED</b> appears briefly on the display
	The display moves to <b>ICAO CODE</b> menu item

### 7.3 ICAO CODE

The ICAO code is an essential part of all ADS-B messages. The operator should check with the Civil Aviation Authority, to ensure what the correct ICAO code for their aircraft is.

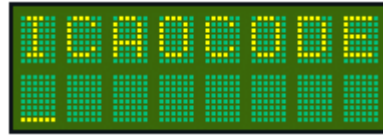

Press <b>ENTER</b> key	Until <b>ICAO CODE</b> message appears
Rotate <b>CODE SELECT</b> knob	Adjust the digit highlighted by the cursor.
Press <b>CODE SELECT</b> knob	Moves the digit to the right
Press <b>ENTER</b> key	The message <b>SAVED</b> appears briefly on the display
	The display moves to <b>EMIS CAT</b> menu item

The ICAO CODE is limited to the hex-decimal character set of numbers 0-9, and letters A-E.



**IMPORTANT NOTE**

*All ADS-B message include the ICAO CODE data. No ADS-B operation will be possible if the ICAO CODE is not entered. The unit will not operate until this code is set.*

### 7.4 Emitter Category

The emitter category is an essential piece of ADS-B data, which is used to describe the aircraft “type”. The T2000ADSB has restricted the category selections to those which are required to transmit airborne ADS-B messages only

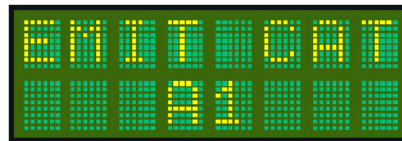

Press <b>ENTER</b> key	Until <b>EMIT CAT</b> message appears
Rotate <b>CODE SELECT</b> knob	Scroll to select the desired Emission Category. The default is A0.
Press <b>ENTER</b> key	The message <b>SAVED</b> appears briefly on the display
	The display moves to <b>A/C ID</b> menu item

Emission Category	Description
A1	Light (< 15,500lbs)
A7	Rotorcraft
B1	Glider / Sailplane
B2	Lighter – than – air
B4	Ultralight / hang-glider / paraglider
C1	Surface Vehicle - Emergency Vehicle
C2	Surface Vehicle - Service Vehicle
C3	Point Obstacle
C4	Cluster Obstacle
C5	Line Obstacle

If you are uncertain of which emitter category is applicable to your aircraft, contact your civil aviation authority for advice. To ensure that ADS-B operation is possible, the emitter category is defaults to A1.

## 7.5 Aircraft ID

The Aircraft ID data is the default for the Flight ID which assists ATC to uniquely identify individual aircraft. The Flight ID is typically the aircraft’s registration, but the operator should check with the Civil Aviation Authority for their correct Flight ID format.

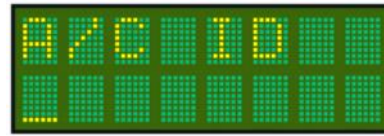

The aircraft ID is the default for the flight ID in the **MODE MENU**. If the Flight ID is not entered the ADS-B message will transmit “null” in the Aircraft Identification message.

Press <b>ENTER</b> key	Until <b>A/C ID</b> message appears
Rotate <b>CODE SELECT</b> knob	Adjust the digit highlighted by the cursor.
Press <b>CODE SELECT</b> knob	Moves the digit to the right
Press <b>ENTER</b> key	The message <b>SAVED</b> appears briefly on the display
	The display moves to next menu item

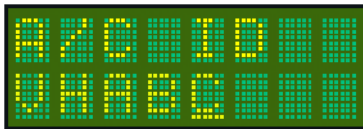

The Aircraft ID can have a maximum of 8 characters, and can consist of capital letters A-Z and the numbers 0-9 with spaces in the trailing unused positions (spaces are not allowed in or within the Flight or Aircraft IDs).

## 7.6 ENCODER SOURCE

The T2000ADSB is able to use altitude information from either its internal encoder, or serial or parallel (Gillham) altitude data. If Gillham is selected the T2000ADSB will detect altitude code over the 10 line Gillham interface. If serial is selected the T2000ADSB will detect altitude data over the RS-232 interface.

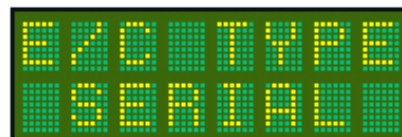
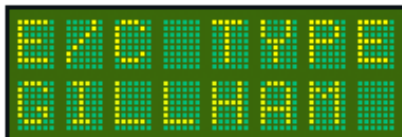

Serial data can be in any one of the following protocols.

- Garmin AT
- Magellan
- Northstar / Garmin
- Trimble / Garmin
- Microair Avionics

Press <b>ENTER</b> key	Until <b>ENCODER SOURCE</b> message appears
Rotate <b>CODE SELECT</b> knob	Scroll to select the Altitude Source (Internal, Gillham, Serial).
Press <b>ENTER</b> key	The message <b>SAVED</b> appears briefly on the display
	The display moves to <b>EXIT PROGRAM</b> menu item

If the serial data supplies altitude with resolution to 25 foot increments, the T2000ADSB will transmit ADS-B message with the barometric altitude data resolved to 25 feet. The displayed altitude will also be resolved to 25 feet. Where the serial data supplies altitude with resolution to 100 foot increments, the transmitted and display altitudes will be resolved to 100 feet only. When the internal altimeter is selected the displayed altitude has a resolution of 1ft and the ADSB transmitted resolution will be 25ft.



## 7.7 ALTITUDE UNIT

The altitude data can be displayed in feet or meters. Once the Altitude units are set, all altitude data is displayed in these units.

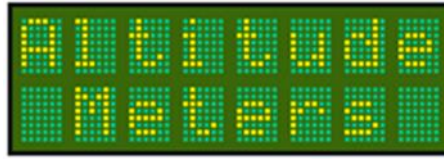

Press <b>ENTER</b> key	Until <b>ALTITUDE UNIT</b> message appears
Rotate <b>CODE SELECT</b> knob	Rotate the Code Select to select the unit (Feet or Meters)
Press <b>ENTER</b> key	The message <b>SAVED</b> appears briefly on the display
	The display moves to <b>EXIT PROGRAM</b> menu item

## 7.8 BAROMETER UNIT (Mb or inHg)

The barometric pressure units used by the T2000ADSB can be either MB = millibars, or HG = inches Mercury.

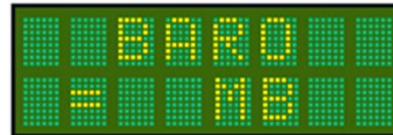

Press <b>ENTER</b> key	Until <b>BAROMETER UNIT</b> message appears
Rotate <b>CODE SELECT</b> knob	Rotate the Code Select to select the unit (Mb or inHg)
Press <b>ENTER</b> key	The message <b>SAVED</b> appears briefly on the display
	The display moves to <b>EXIT PROGRAM</b> menu item

## 7.9 AIR GROUND LOGIC

For aircraft using the remote air/ground input line (pin 15), the operation of the switch can be changed by the software to suit the aircraft.

If the air/ground switch closes to ground when the aircraft is on the ground then the operation is **Norm** (normal).

If the air/ground switch closes to ground when the aircraft is in the air then the operation is **Rev** (reverse).

If the aircraft doesn't use an air/ground switch then select **GPS** which will use aircraft ground speed to determine air/ground logic for ADSB.

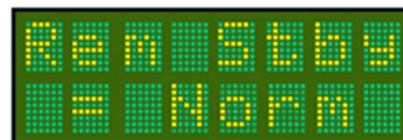

Press <b>ENTER</b> key	Until <b>AIR GROUND LOGIC</b> message appears
Rotate <b>CODE SELECT</b> knob	Rotate the Code Select to select either <b>Norm</b> , <b>Rev</b> or <b>GPS</b>
Press <b>ENTER</b> key	The message <b>SAVED</b> appears briefly on the display
	The display moves to <b>EXIT PROGRAM</b> menu item

## 7.10 ADSB VERSION

Selects the versions of ADSB messaging which can be Version 2 or Version 3. Default is Version 2.

Press <b>ENTER</b> key	Until <b>ADSB VERSION</b> message appears
Rotate <b>CODE SELECT</b> knob	Rotate the Code Select to select either <b>Version 2</b> or <b>Version 3</b>
Press <b>ENTER</b> key	The message <b>SAVED</b> appears briefly on the display
	The display moves to <b>EXIT PROGRAM</b> menu item

## 7.11 EXIT PROGRAM

This is the end of the **PROGRAM MODE** menu. The user can exit by pressing the **ENTER** key. The T2000ADSB will restart in the operational mode.



The user can exit the **PROGRAM MODE** menu at any time, from any menu item, by pressing the **toggle** key. To re-enter the **PROGRAM MODE** menu the **T2000ADSB** must be turned off, and re-started using the **ON** and **MODE** keys (refer **PROGRAM MODE** section).



## 8.0 CALIBRATION & TESTING OF INSTALLATION

Please refer to the Civil Aviation rules or regulations for your country to determine what the calibration requirements are for a transponder installation.

For certified aircraft, most countries will require a test of the installation to be carried out by a qualified test centre, along with a calibration of the encoder and altimeter in the aircraft. For experimental aircraft, most regulatory authorities requires that the installer be responsible to ensure that the installation meets the required functional performance.

This test is typically repeated every two years, to ensure the ongoing accuracy of the system.



### IMPORTANT NOTE

*It is vital to aircraft safety that all transponder/encoder/altimeter systems, which will operate within an SSR system or interact with TCAS equipped aircraft, perform to a minimum civil aviation standard.*

*For this reason, Microair strongly recommends that all transponder installations be calibrated at the time of installation, and at periods of not greater than two years thereafter.*

### 8.1 IFR6000 Test Procedure

Refer to FAA FAR Part 43 appendix E and F for typical transponder/encoder/altimeter equipment calibration procedures. The diagram below illustrates a standard set up for the testing of the transponder/encoder/altimeter equipment.

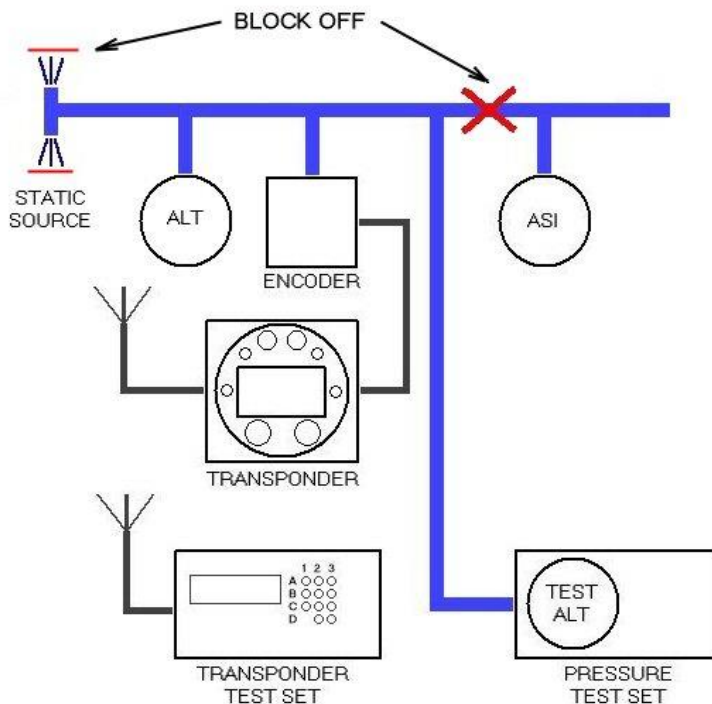

## 8.2 ADSB TEST PROCEDURE

Microair recommends the use of an IFR6000 test set for use in the validation of ADS-B installations.

Note, before commencing your test, ensure that the aircraft GPS has a clear view of the sky / GPS constellation to be able to generate good HPL/NIC. Normally, testing within the confines of a hangar will not yield acceptable results. Ensure GPS has established a position prior to carrying out these tests (this can be checked by pressing (I) in the Disp Alt mode and confirming time, LAT, LON etc are present)

Set up the IFR6000 per the manufacturer's instruction for ADSB monitoring ensuring the following settings:

1. Ensure that ADSB MON is set to DF18.
2. Ensure the aircrafts Mode S address is entered.

Select ADSB Version 2 on the T2000ADSBs Program menu.

With the aircraft in Surface mode (i.e. Squat switch active, Air switch inactive or GPS speed below 20kts) ensure the following messages are available:

1. SURFACE POS. Confirm the ICAO code, Position (LAT/LON) and NIC/Rc are correct.
2. IDENT & CAT. Confirm the ICAO code, Flight ID and Emitter Category are correct.
3. A/C STATUS ST1. Confirm the ICAO code and Mode A code are correct. Enter code 7500, 7600 or 7700 on the T2000ADSB and ensure the EMERG/PRIOR Code is correct.

Simulate the aircraft being in the air (follow the aircraft maintenance manual or often the easiest way is to enter Program Mode on the T2000ADSB and change the AIR/GND Logic from Norm to Rev or vice versa). Ensure the following messages are available:

1. AIRBORNE POS. Confirm the ICAO code, Position (LAT/LON), Altitude and NIC/Rc are correct.
2. AIRBORNE VAL. Confirm the ICAO code, Velocity (E-W, N-S), vertical rate and NACV are correct.
3. IDENT & CAT. Must be present but no further testing required is performed for Surface message.
4. A/C STATUS ST1. Must be present but no further testing required is performed for Surface message.

## 8.3 BACKGROUND INFORMATION ON INTEGRITY

### 8.3.1 Integrity NUC

If the aircraft is transmitting **SURFACE** squits (eg: squat switch is active), then the type code needs to be 5,6 or 7 in accordance with the table below.

Type code	Rc	NUC	Validity
5	<7.5m	9	Valid
6	<25m	8	Valid
7	<185.2m	7	Valid
8	>185.2m	6	Not useable – indicates no Integrity

If the aircraft is transmitting **AIRBORNE** extended squitters then the type code needs to be 9-15 in accordance with the table below.

Type code	Rc	NUC	Usable by ATC	Observed frequency of type code (as expected)
9	<7.5m	9	Yes	Rare
10	<25m	8		Common
11	<185.2m	7		Common
12	<0.2 nm	6		Common
13	<0.5 nm	5		Less Common
14	<1.0nm	4		Infrequent
15	<2.0 nm	3	No	Unlikely
16	<10 nm	2		
17	<20 nm	1		
18	>20 nm	0	Not useable – indicates no Integrity	

A “good” installation needs to transmit a NIC of at least 6, 7 or 8. A lower NIC for any period indicates something is wrong.

The containment radius (Rc or Horizontal Protection Level HPL) is calculated by the GPS receiver based on which GPS satellites it is receiving and the satellite geometry. It does not depend on actual measurements of the received satellites. Aircraft in the same position should calculate almost the same HPL value when exposed to the same satellite constellation.

Aircraft with a clear view of the sky should be generating HPL values below 0.2 nautical miles a very large percentage of the time. Therefore expect to see NIC=7,8 or 9. Nearly all aircraft output NIC=6 to 9 all the time. A NIC=5 or 4 only occurs very rarely when there is a GPS constellation issue. If NIC=5 or below then something is probably wrong because real HPLs do not get this low.

### 8.3.2 Accuracy NAC

It is important that NAC be non zero. NAC is reported in Type 31 and Type 29 messages. The aircraft HFOM needs to be 5-11 as per the table below.

HFOM	NAC	Usable by ATC
<3m	11	Yes
<10m	10	
<30m	9	
<0.05nm	8	
<0.1nm	7	
<0.3nm	6	
<0.5nm	5	
<1nm	4	No
<2nm	3	
<4nm	2	
<10nm	1	
<20nm	0	Not useable – indicates no accuracy

### 8.3.3 Integrity SIL

It is important that SIL be a value of 3. SIL is reported in Type 31 and Type 29 messages.

SIL	Integrity
0	No integrity
1	Inadequate Integrity
2	Acceptable Integrity
3	

## 9.0 WIRING DIAGRAMS

The drawings defined below for the T2000SFL, are all applicable to the new T2000ADSB and can be installed as approved harnesses.

- T2000SFL with EC2002 Altitude Encoder – Serial
- T2000SFL with EC2002 Altitude Encoder - Gillham
- T2000SFL with AK-350 Altitude Encoder
- T2000SFL with A-30 Altitude Encoder
- T2000SFL with Enigma Multi-Function Display
- T2000SFL with Dynon D10A Multi-Function Display – Gillham
- T2000SFL with Dynon D10A Multi-Function Display - Serial

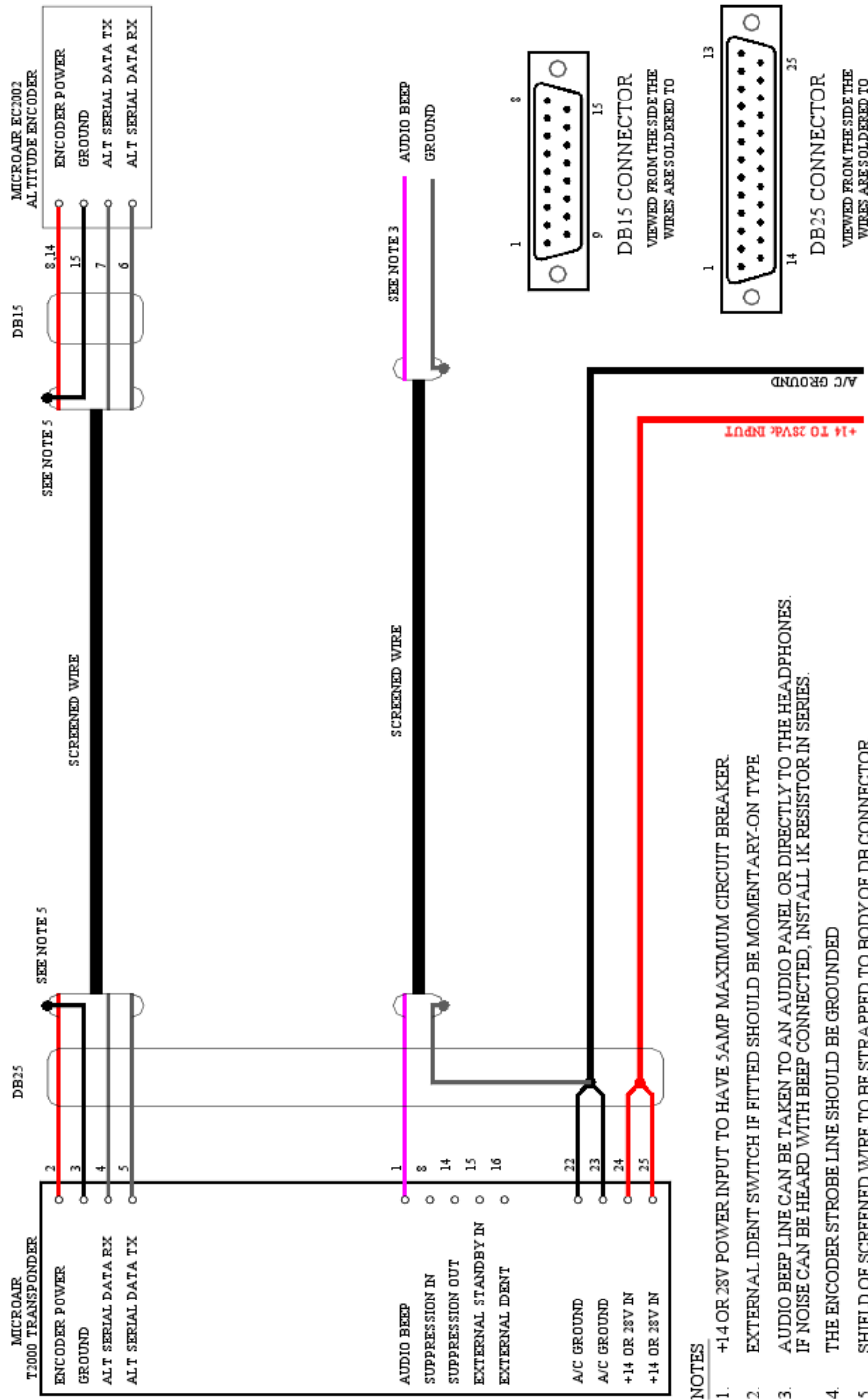

- NOTES**
1. +14 OR 28V POWER INPUT TO HAVE 5AMP MAXIMUM CIRCUIT BREAKER.
  2. EXTERNAL IDENT SWITCH IF FITTED SHOULD BE MOMENTARY-ON TYPE.
  3. AUDIO BEEP LINE CAN BE TAKEN TO AN AUDIO PANEL OR DIRECTLY TO THE HEADPHONES. IF NOISE CAN BE HEARD WITH BEEP CONNECTED, INSTALL 1K RESISTOR IN SERIES.
  4. THE ENCODER STROBE LINE SHOULD BE GROUNDED.
  5. SHIELD OF SCREENED WIRE TO BE STRAPPED TO BODY OF DB CONNECTOR.
  6. HARNESS LENGTHS OF 600MM (+/- 25MM) ARE TO BE AVOIDED TO REDUCE THE INSTANCE OF RF INTERFERENCE FROM VHF RADIO.
  7. THIS DIAGRAM IS APPLICABLE TO REVISIONS 5, 6, & 7.

## MICROAIR T2000SFL - WIRING DIAGRAM WITH MICROAIR EC2002 ENCODER

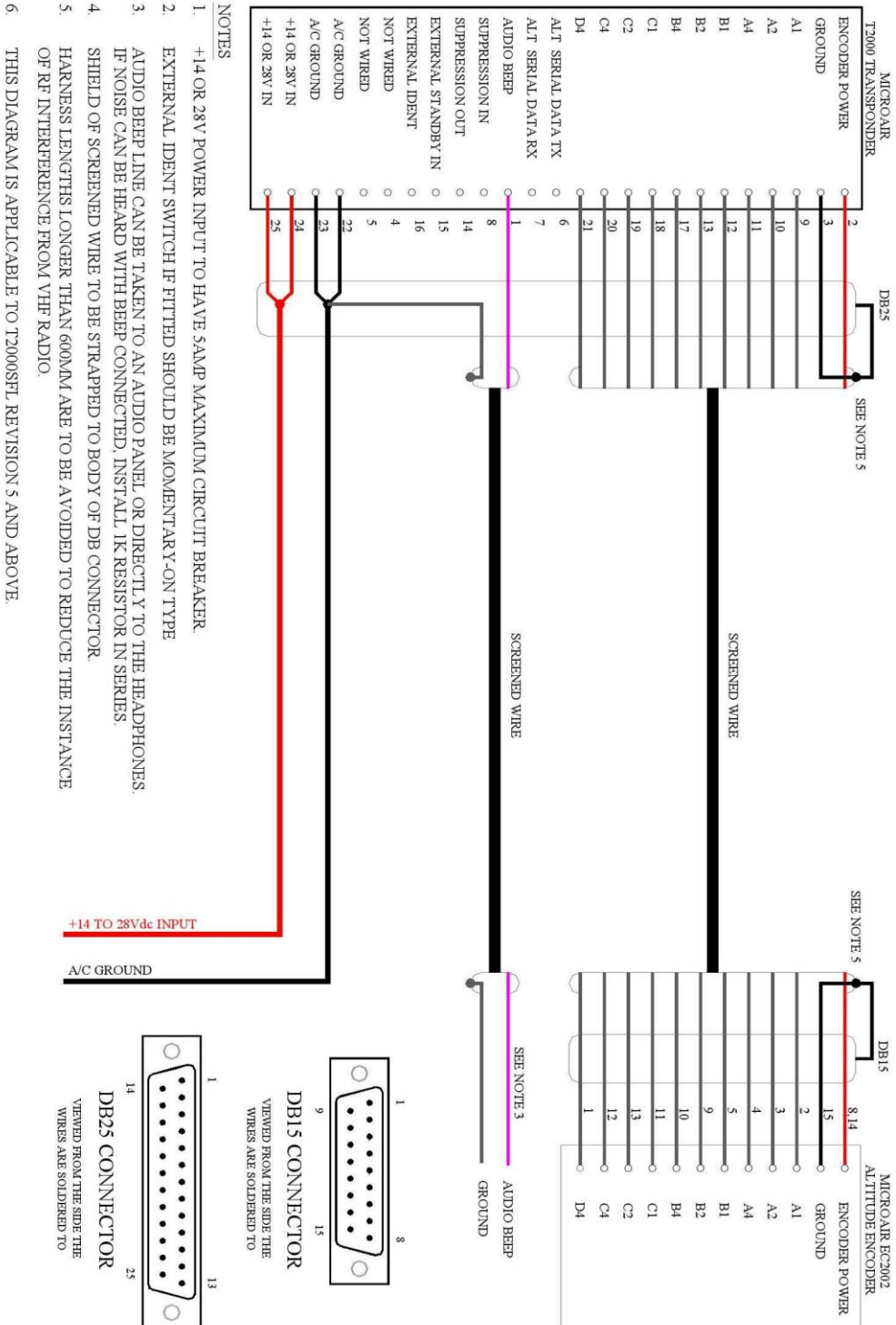

## MICROAIR T2000SFL - WIRING DIAGRAM

WITH MICROAIR EC2002 ENCODER  
(GILLHAM)

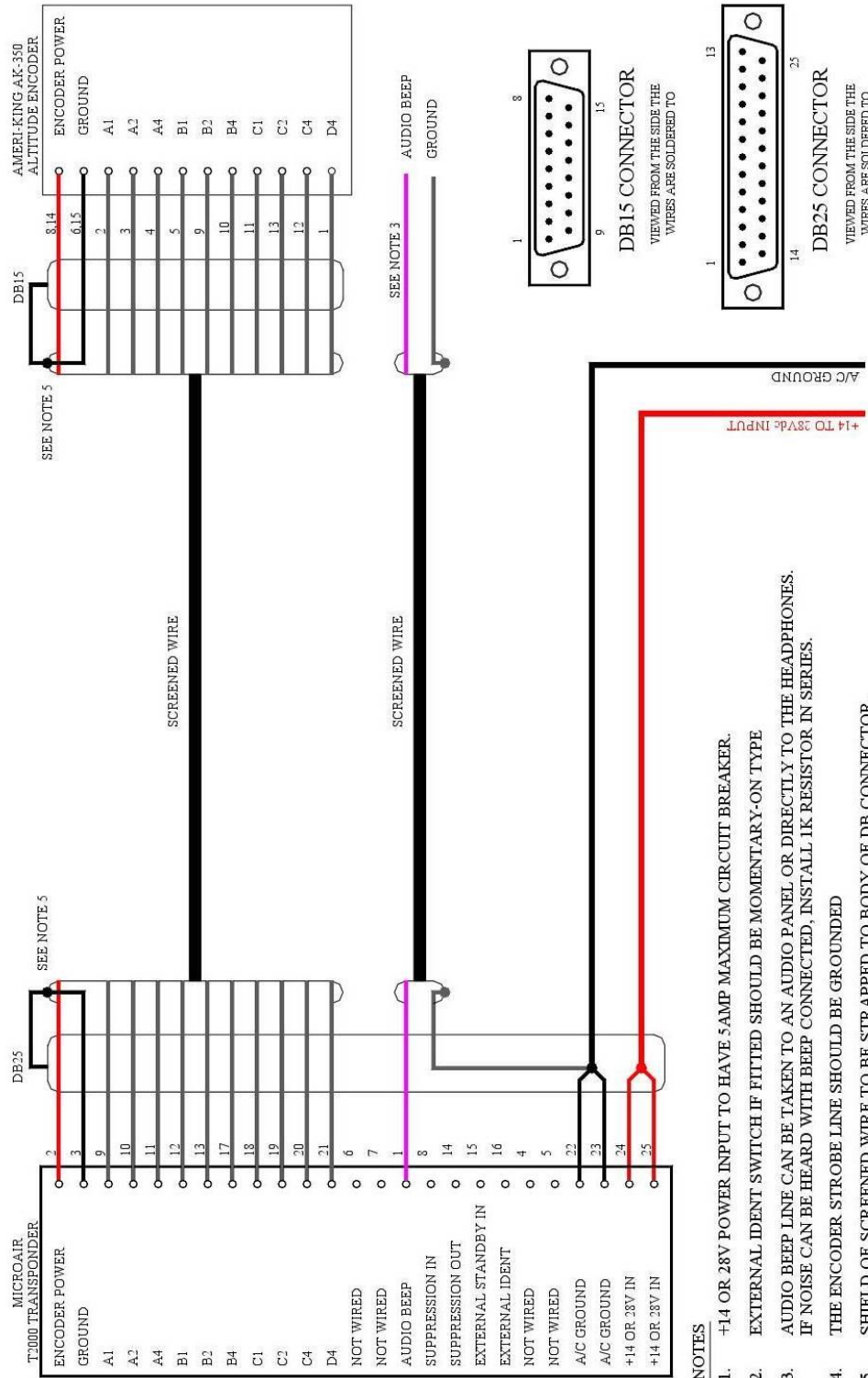

## MICROAIR T2000SFL - WIRING DIAGRAM WITH AMERI-KING AK-350 ENCODER



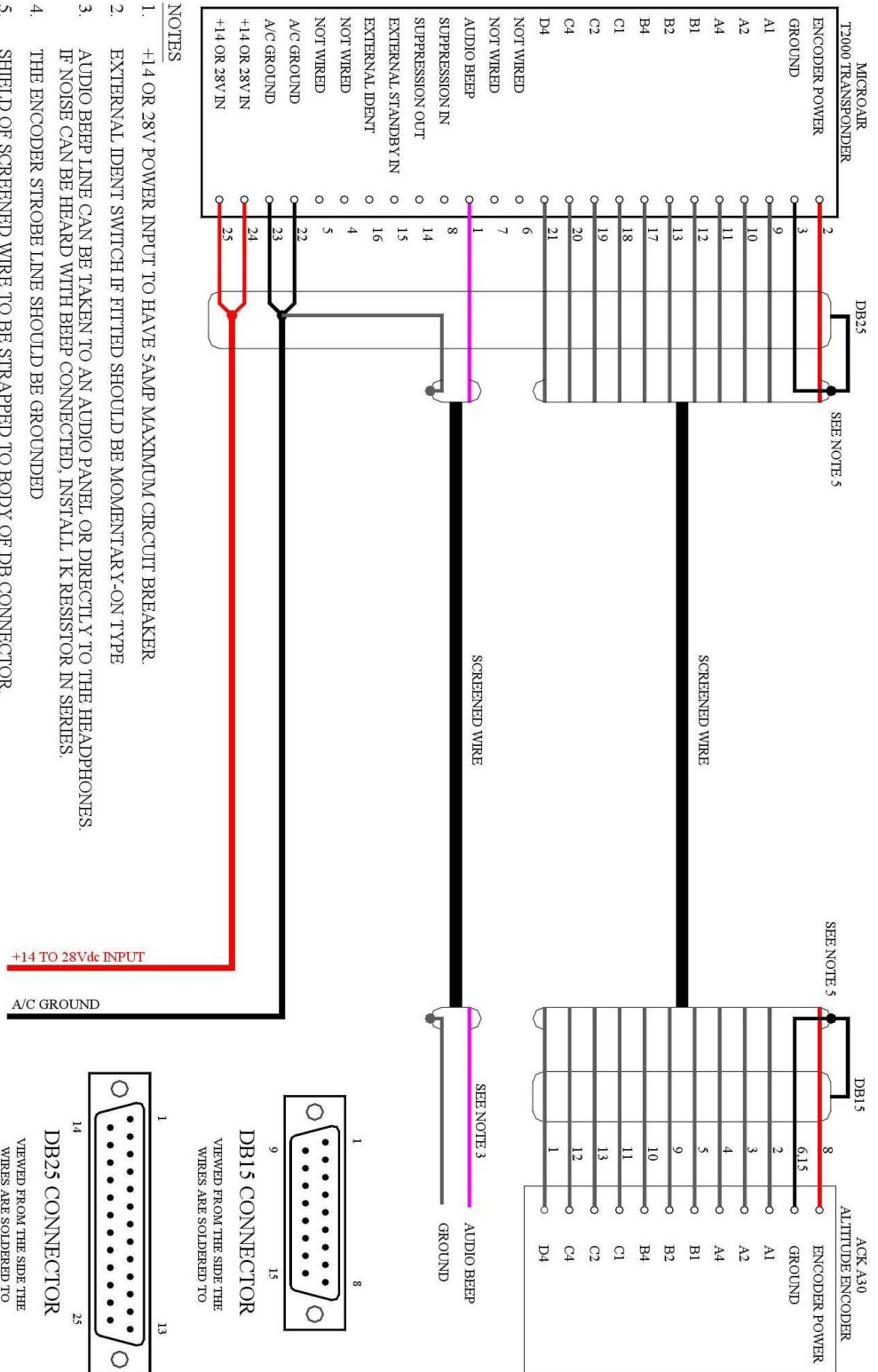

## MICROAIR T2000SFL - WIRING DIAGRAM

WITH ACK A30 ENCODER



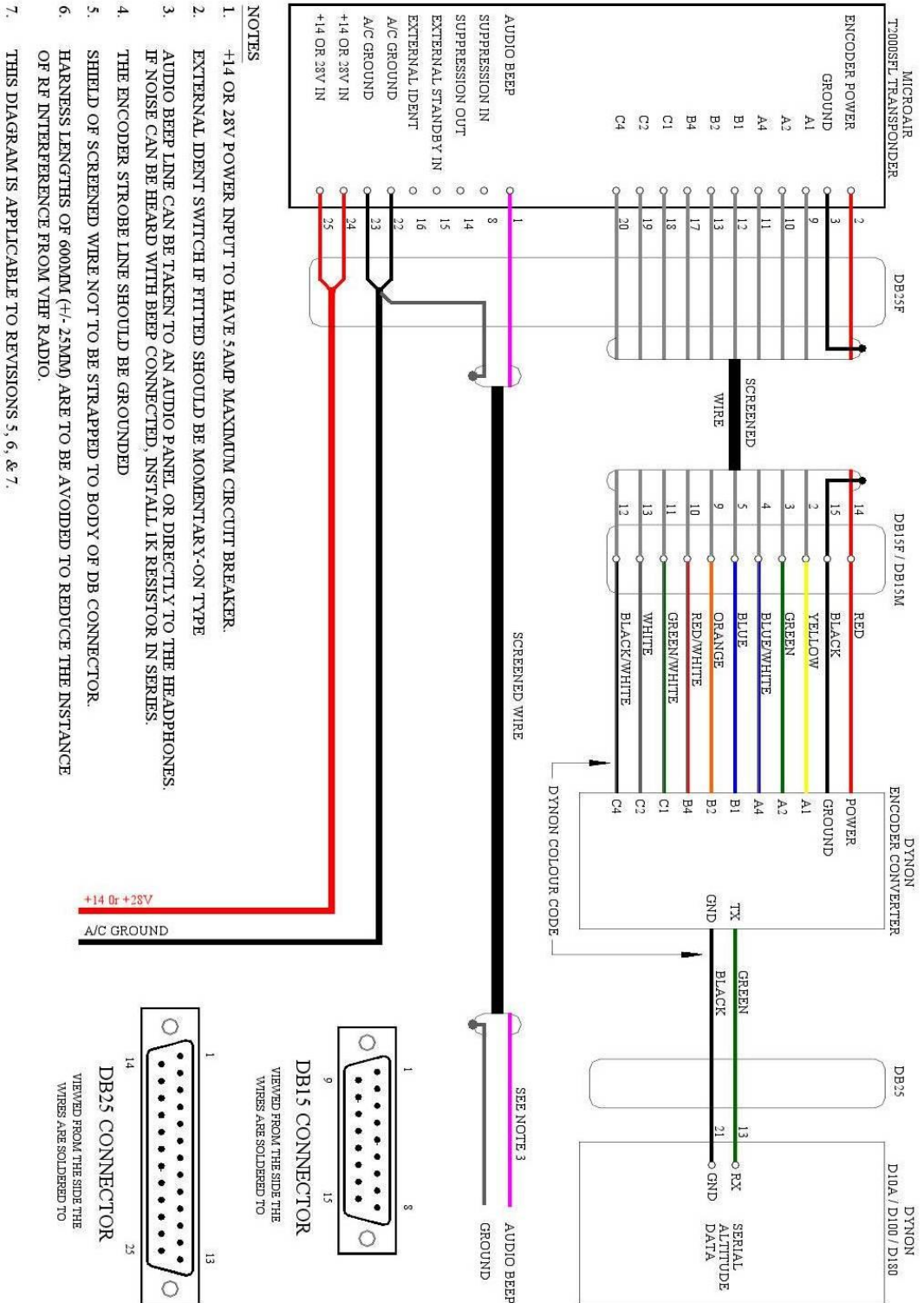

## MICROAIR T2000SFL - WIRING DIAGRAM

WITH DYNON D10A / D100 / D180 ENCODERS

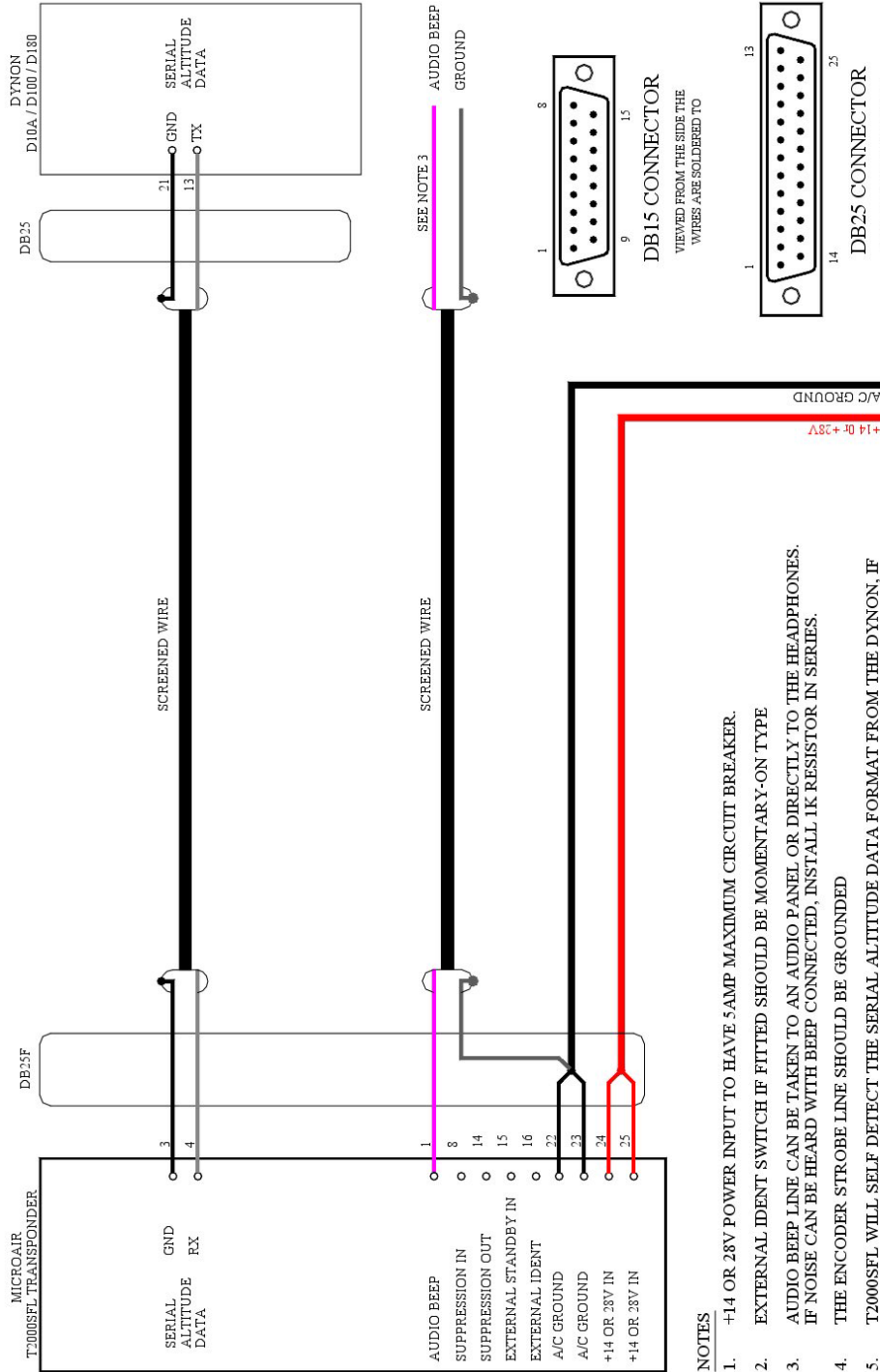

## MICROAIR T2000SFL - WIRING DIAGRAM

WITH DYNON D10A / D100 / D180 ENCODERS

## 10.0 INSTALLATION DIMENSIONS

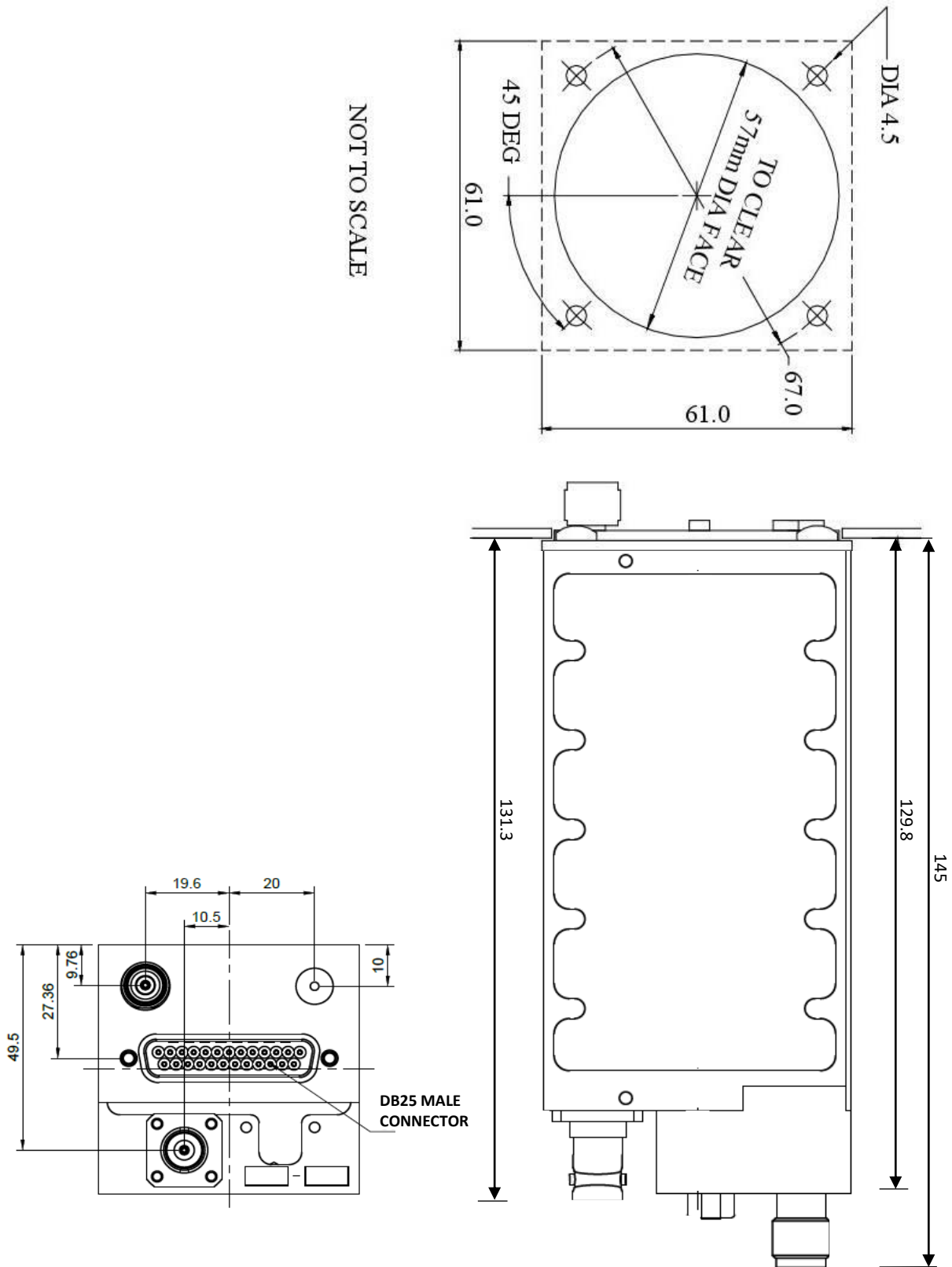



## 11.0 PIN ASSIGNMENTS

Pin	Assignment
1	BEEP AUDIO TONE
2	ENCODER SWITCHED POWER OUT (= A/C POWER)
3	GROUND
4	ALT SERIAL DATA RX
5	ALT SERIAL DATA TX
6	NOT WIRED
7	NOT WIRED
8	SUPPRESSION IN (5 TO 20V)
9	GILLHAM CODE A1
10	GILLHAM CODE A2
11	GILLHAM CODE A4
12	GILLHAM CODE B1
13	GILLHAM CODE B2
14	SUPPRESSION OUT (5V)
15	EXTERNAL STANDBY (GROUND TO OPERATE)
16	EXTERNAL IDENT (GROUND TO OPERATE)
17	GILLHAM CODE B4
18	GILLHAM CODE C1
19	GILLHAM CODE C2
20	GILLHAM CODE C4
21	GILLHAM CODE D4
22	A/C GROUND
23	A/C GROUND
24	A/C POWER (+10V TO +33V)
25	A/C POWER (+10V TO +33V)

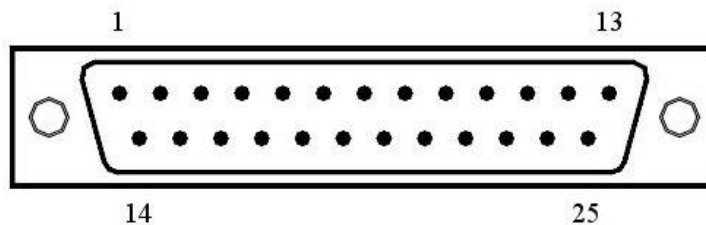

### DB25 CONNECTOR

VIEWED FROM THE SIDE THE  
WIRES ARE SOLDERED TO

## 12.0 PANEL TEMPLATE

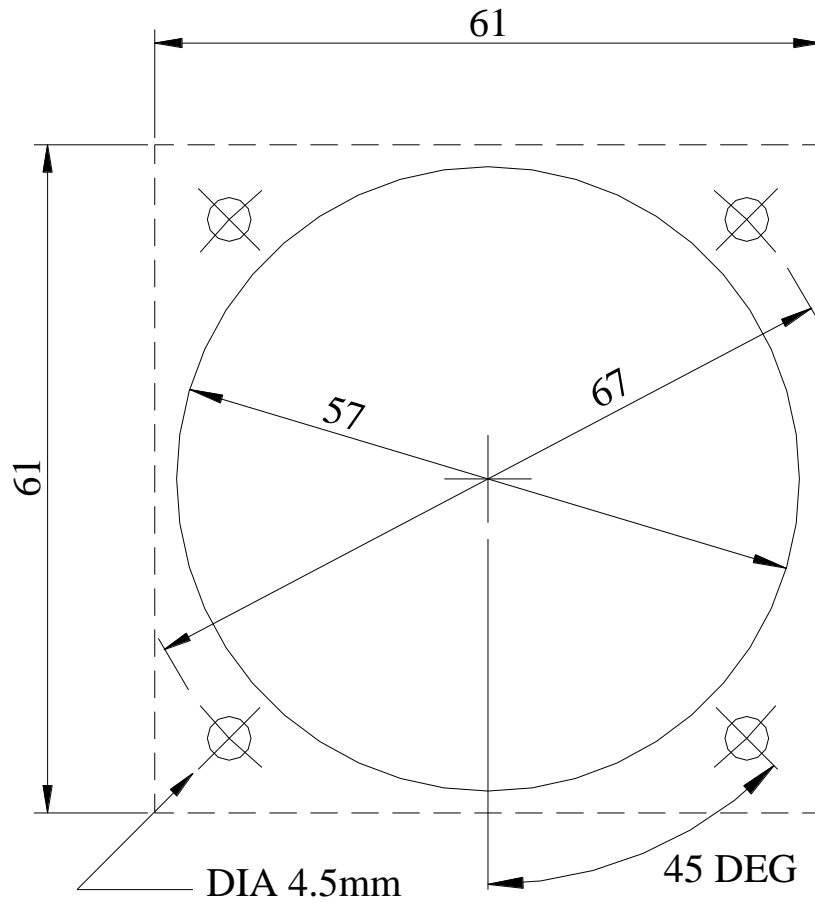

## 13.0 SPECIFICATIONS

TSO Equivalence	<ul style="list-style-type: none"> <li>• C74c Class 1a Transponder</li> <li>• C166b Class B0 1090MHz ADS-B Out (with Class B1S power output and antenna configuration) – meets all relevant 14CFR 91.227 requirements.</li> <li>• C196b Position Source</li> <li>• C106c and C88a Altimeter (to 30,000')</li> </ul>
Transmitter	<p>1090MHz +/-0.2MHz 200W Pulse Output</p>
Receiver (1030MHz)	<p>-7 to -71dBm Dynamic Range 1030MHz Centre Frequency +/-5MHz Pass band</p>
Input Power	<p>10-33Vdc 100-150mA @ 28V 150-250mA @ 14V</p>
Transponder Modes	<p>Standby Mode 3A Mode 3A/C</p>
ADS-B Messages	<p>Airborne (Types 0, 11-18) Surface (Types 0, 7, 8) Identification and Category (Types 2-4) Airborne Velocity (Type 19) Emergency/Priority Status (Type 28 Subtype 1) Operational Status (Type 31)</p>
Dimensions	<p>Length 145mm (5.7") Width 61mm (2.4") Height 61mm (2.4")</p>
Weight	<p>685g (24 oz)</p>



