

Vega ALT-5

Altimeter and Vertical Speed Indicator
with a transponder compatible serial
RS232 output

Operating Manual – English 1.00

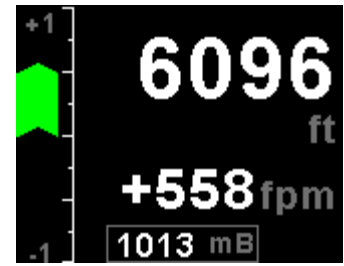

Introduction

The ALT-5 is a 2 1/4" sunlight readable encoding altimeter and a wide range vertical speed indicator.

The altimeter contains an internal high accuracy 24 bit digital altitude sensor which calculates altitude from -1000 ft up to a maximum of 35000 ft. The ALT-5 outputs various formatted RS232 serial data protocols compatible with serial input transponders such as that from Garmin, Magellan, Northstar, Trimble, Microair etc. The altimeter can display altitude in feet or meters and local pressure can be set in millibars or inches of mercury

The VSI indicator can be displayed in either feet/minute (ft/min) or meters/second (m/s). The VSI can be calibrated by the user once the instrument has been installed in the aircraft.

The ALT-5 also features a user settable altitude bug and an encoder test function. The ALT-5 provides a parallel Gillham code interface when used in conjunction with the MGL Avionics CNV-ALT.

1 Features

- Large 1.8" high resolution 160x128, sunlight readable, wide viewing angle, 1000 cd/m² TFT LCD display
- An internal high accuracy 24 bit digital altitude sensor calculates altitude from -1000 ft up to a maximum of 35000 ft (-304m to 10668m)
- The ALT-5 outputs various formatted RS232 serial data protocols compatible with serial input transponders such as that from Garmin, Magellan, Northstar, Trimble, Microair etc.
- Provides a parallel Gillham code interface for transponders when used in combination with the MGL Avionics CNV-ALT
- Built in encoder test function
- The altimeter can display altitude in feet or meters
- Local pressure can be set in millibars or inches of mercury
- Contains a wide range VSI indicator from +/-20 ft/min to as high as +/-10000 ft/min
- VSI units can be in feet/minute (ft/min) or in meters/second (m/s)
- User settable altitude bug
- Standard 2 1/4" aircraft enclosure (can be front or rear mounted)
- Rotary control plus 2 independent buttons for easy menu navigation and user input
- Wide input supply voltage range of 8 to 30V DC with built in voltage reversal and over voltage protection for harsh electrical environments
- 1 year limited warranty

2 ALT-5 Layout



Sunlight readable color graphic display:
Backlight can be adjusted in the menu system

2 1/4" enclosure.
Can be front or rear mounted

F1 / Up Button:
Menu system: Softkey button
Normal display: Enable/disable altitude bug

F2 / Down Button:
Menu system: Softkey button
Normal display: Altitude bug setting display

Rotary Control (Up/Down) & Enter Button:
Press the rotary control during the normal display screens to access the menu system. Rotate anti/clockwise for up/down menu scrolling. Rotate the rotary control during the normal display mode to adjust the local pressure. Local pressure can be set in either mB or in "Hg.

3 Main Displays

The ALT-5 has 2 different display screens. The main display screen can be selected in the "ALT SETUP" menu.

3.1 Altitude "TAPE" Display

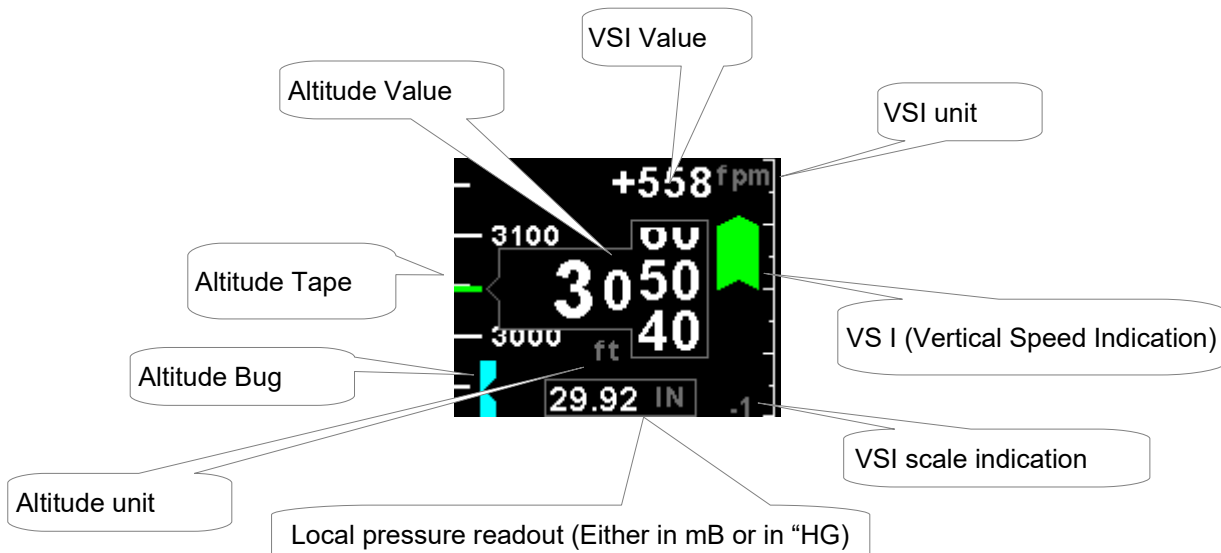

3.2 Altitude "CLASSIC" Display

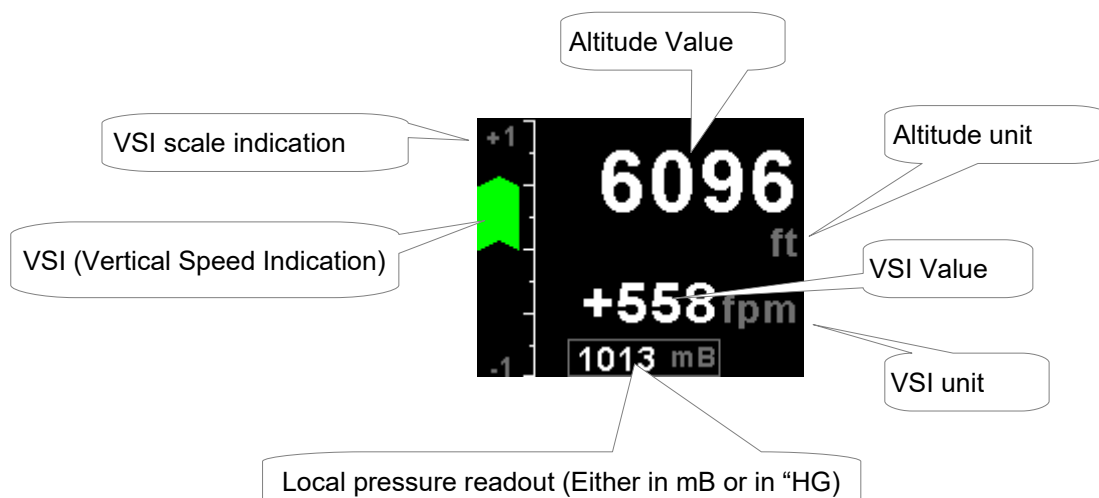

3.3 Altitude Bug



Press the F2/Down button during the altitude "TAPE" display to access the altitude bug setting screen. Press the F1/UP key to set the altitude bug to the current altitude or use the rotary control to adjust the altitude bug. Press the F2/Down key to change the increment / decrement unit to 50 or 500. Press the rotary control to exit and save.

Press the F1/Up button during the normal altitude "TAPE" display to enable or disable the altitude bug. The bug will be yellow when in the display screen and cyan when either above or below the limits of the display.

4 Menu System

Press the rotary control button during the normal display mode to enter the menu system. Use the rotary control to navigate through the menu system.



4.1 Exiting the menu system

Press the F1/Up button to exit the menu system when the “EXIT” soft key is shown. All changes made during navigation of the menu system will be saved in non-volatile memory upon exiting. The instrument will not save any changes if you remove power before exiting the menu system.

4.2 ALT Setup (Altitude Setup)



Style:

Select the altitude display screen. Options include “TAPE” or “CLASSIC”.

Altitude Unit:

Select if you want the altitude displayed in ft (feet) or m (meters).

Pressure Unit:

Select if you want the local pressure displayed in mB (millibars) or “Hg (inches of mercury).

Resolution:

Select the resolution of the altitude value, a selection of 1,10,25 or 100 ft or m can be selected.

Cal:

On the rear of your ALT-5 instrument you will find the calibration factor that has been determined to ensure the most accurate reading of your altimeter. This is the value that should be entered here. Should you have access to an accurate reference you may use this function to calibrate your altimeter. Before you do this, ensure that your calibrated and certified reference is set to the local pressure of 1013.25mB (29.92”HG). Your altimeter has been calibrated by the factory to an accuracy of +/- one mB or approximately +/- 30 ft (10m) at sea level.

Serial Out:

Select “ON” to enable the RS232 serial altitude output. This formatted serial RS232 message can be directly interfaced to various RS232 serial input transponders. If a parallel Gillham output is required then a CNV-ALT can be purchased from your MGL Avionics distributor to convert the RS232 output to a parallel Gillham output.

Prot:

Select the protocol of the serial RS232 output message. The protocol can be selected between GARMIN AT, Magellan, Northstar / Garmin, Trimble / Garmin, MGL Avionics and Microair UAV. Please note that the baud rate is automatically adjusted according to which protocol is selected. The output format is as follows. The message contains the current pressure altitude with a fixed reference to 1013.25mB (29.92 inches mercury). All protocols use 8 databits, no parity, and 1 stop bit. The message is outputted once a second.

Protocol	Baud Rate	Message format	Example
Garmin AT	1200	#AL, space, +/-, five altitude digits right justified zero padded, T+25, checksum, carriage return The checksum is a simple modulo 256 sum of the binary values of the individual characters. The checksum is sent as two characters in hexadecimal format	#AL +02372T+25DF[CR]
Magellan	1200	#MGL, +/-, five altitude digits right justified zero padded, T+25, checksum, carriage return The checksum is a simple modulo 256 sum of the binary values of the individual characters. The checksum is sent as two characters in hexadecimal format	\$MGL+02372T+2513[CR]
Northstar, Garmin	4800	ALT, space, five altitude digits right justified zero padded, carriage return	ALT 02372[CR]
Trimble, Garmin	9600	ALT, space, five altitude digits right justified zero padded, carriage return	ALT 02372[CR]
MGL Avionics	9600	ALT, +/-, five altitude digits right justified zero padded ,1013.25mB (29.92”Hg) referenced, C, +/-, five altitude digits right justified zero padded (corrected to local pressure), L, local pressure setting in millibars,+/-, four digit VSI reading right justified zero padded in ft/min, X, checksum, carriage return The checksum is a simple modulo 256 sum of the binary values of the individual characters. The checksum is sent as two characters in hexadecimal format	ALT+02372C+02372L1013+0000XCA[CR]
Microair UAV	9600	STX,a,=, five altitude digits right justified zero padded, ETX	[STX]a=02372[ETX]
STX=0x02 ETX=0x03 CR=0x0D			

Test Alt Encoder:

This is a handy function to test the ALT-5 transponder interface once the installation has been completed. The serial output will output specific altitudes which can then be used to test the serial RS232 output and the parallel gillham output if using a CNV-ALT converter. The ALT-5 will resume the normal output of the indicated altitude upon exiting the test function.

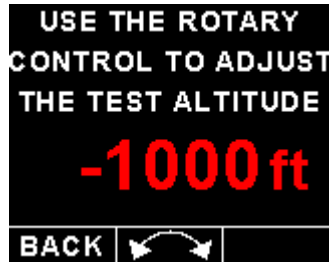

The following codes are outputted:

Altitude	D4	A1	A2	A4	B1	B2	B4	C1	C2	C4
-1000ft	0	0	0	0	0	0	0	0	1	0
-900ft	0	0	0	0	0	0	0	1	1	0
-700ft	0	0	0	0	0	0	1	1	0	0
-400ft	0	0	0	0	0	0	1	0	1	1
-200ft	0	0	0	0	0	1	1	0	0	1
800ft	0	0	0	0	1	1	0	0	0	1
2800ft	0	0	0	1	1	0	0	0	0	1
6800ft	0	0	1	1	0	0	0	0	0	1
14800ft	0	1	1	0	0	0	0	0	0	1
30800ft	1	1	0	0	0	0	0	0	0	1

Each altitude reporting code line must be tested for integrity of connection if at any time the aircraft connections to the transponder or altitude data source have been removed and reconnected. Integrity of the connections may be verified by performing a test of mode C function of the transponder system.

Warning: Do not use this function while in flight as incorrect altitude information will be sent to the transponder.

4.3 VSI Setup (Vertical Speed Indicator Setup)

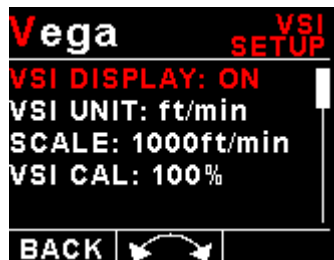

VSI Display:

Select if you want the VSI display to be shown on the altitude "TAPE" display. The VSI display is always shown on the altitude "CLASSIC" display.

VSI Unit:

Select if you want the VSI to be displayed in "ft/min" (feet/minute) or "m/s" (meters/second).

Scale:

Select the VSI scale most suited for your aircraft.

VSI Cal:

This is a function that is used to calibrate your VSI to read exact rates of climb or decent. This function works as a percentage of initial reading. The default setting for this function is 100%. Increasing this value increases the VSI reading and decreasing the value decreases the reading.

Suggested VSI calibration method

After you have installed the instrument, perform a calibration flight. This should be done in very calm conditions. Turbulence and thermal activity will make accurate calibration impossible. Many areas have ideal conditions during early mornings or late afternoons. Place the instrument in ft/min for ease of calibration. Take your aircraft to a few thousand feet above ground and start a glide with a low power setting. Take a stopwatch and when the glide is stable (stable VSI reading) start the stopwatch. Take note of your altimeter reading at the same time. Continue the stable glide for one minute exactly. After the minute has finished, take another reading of your altimeter.

Example:

VSI reading during stable glide: -400 ft/min

Start altitude: 2500 ft.

End altitude: 2050 ft.

In the above example the VSI is under reading by about 12%. Set your VSI calibration to 112% to cancel out the error.

4.4 MISC Setup (Miscellaneous Setup)

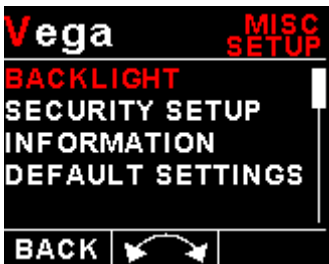

Backlight:

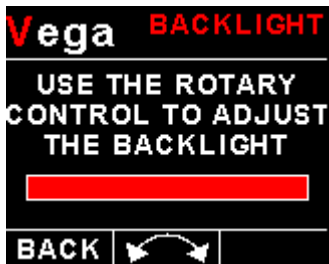

Select this menu option to adjust the backlight brightness.

Security Setup:



Select this menu option if you want to password protect the menu system.

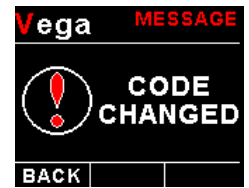
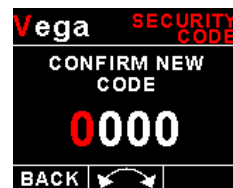
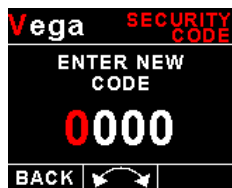
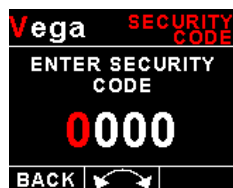

Information:



This menu option displays information about the unit.

Default Settings:

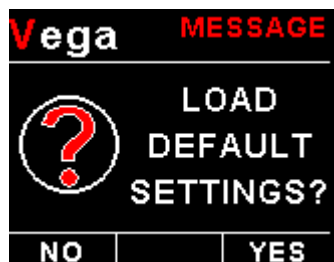

Select this menu option to reset all the settings to factory defaults.

5 Loading factory default settings



Press and hold the F1/Up button and rotary control during power up to load the pre-programmed factory default settings. The following screen will be displayed:

Factory default settings can also be loaded in the Miscellaneous setup menu.

6 Error Messages



Unit settings CRC error. Load default settings to restore to factory defaults. If the error message still persists then it could possibly be a non-volatile memory failure in which case the instrument will then have to be returned to the factory.



Calibration constants CRC error. The instrument could possibly have a non-volatile memory failure in which case the instrument will then have to be returned to the factory.

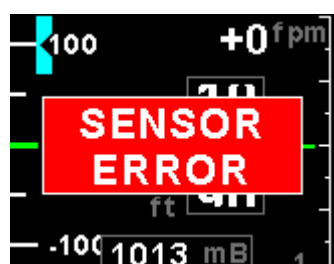

Altitude sensor error. The instrument could have a faulty altitude sensor in which case the instrument will then have to be returned to the factory.

7 ALT-5 Specifications

Operating Temperature Range	-10°C to 60°C (14°F to 140°F)
Storage Temperature Range	-20°C to 80°C (-4°F to 176°F)
Humidity	<85% non-condensing
Power Supply	8 to 30Vdc SMPS (switch mode power supply) with built in 33V over voltage and reverse voltage protection
Current Consumption	Approx. 73mA @ 13.8V (backlight highest setting), 33mA @13.8V (backlight lowest setting)
Display	1.8" 160x128 pixel active matrix TFT display. 1000 cd/m2 Sunlight readable with anti-glare coating LED Backlight is user configurable
Alarm Output	Open collector transistor switch to ground Maximum rating 0.5A
Altitude sensor ADC resolution	24 bit
Dimensions	see Vega series dimensional drawing
Enclosure	2 1/4" ABS, black in color, front or rear mounting. Flame retardant.
Weight	Approx. 120 grams (Instrument excluding cables)
Non-volatile memory storage	100000 write cycles
Altimeter range	-1000ft to 35 000ft (-304m to 10668m)
Altitude units	ft or m
Pressure units	InHG or mB
VSI range	+/-20ft/min to +/-10000ft/min
VSI units	ft/min or m/s
Serial Port	RS232 voltage levels

8 Operating the alarms

The alarm output can be used to switch an external alarm indicator. The external alarm switch is an open collector transistor switch to ground with a maximum rating of 0.5A DC. It is possible to wire the alarm contacts of several Stratomaster instruments in parallel should this be desired. To avoid false activation of the alarms, the alarm function is only active 10 seconds after the instrument has powered up.

9 Firmware Upgrading

The ALT-5 can be upgraded in the field by connecting the RS232 port to a PC and running the firmware update program. **Note that only the RS232 port can be used to upgrade the firmware.**

Please see the Vega firmware upgrading document for more information.

10 Installation

Connect the static port to a suitable static air pressure line. If you have a slow aircraft or an aircraft where the internal cabin pressure does not change during flight and is equivalent to the outside air pressure you may find that it is not required to connect a static port.

For installations in typical ultralight aircraft pods, be aware of possible pressure changes inside the pod during flight caused by ram air or suction effects. This may lead to a false indication of altitude. Often these effects are dependent on the current angle of attack of the airflow around your pod. You will need to install a suitable static port in these cases.

The use of an external 1A fuse is recommended. Connect the supply terminals to your aircraft's power supply. The ALT-5 can be used on both 12V and 24V without the use of any pre-regulators. Ensure that the supply voltage will not drop below 8V during operation as this may result in incorrect readings.

10.1 Connection Diagram

The use of an external 1A fuse is recommended. Connect the supply terminals to your aircraft's power supply. The ALT-5 can be used on both 12V and 24V without the use of any pre-regulators. Ensure that the supply voltage will not drop below 8V during operation as this may result in incorrect readings.

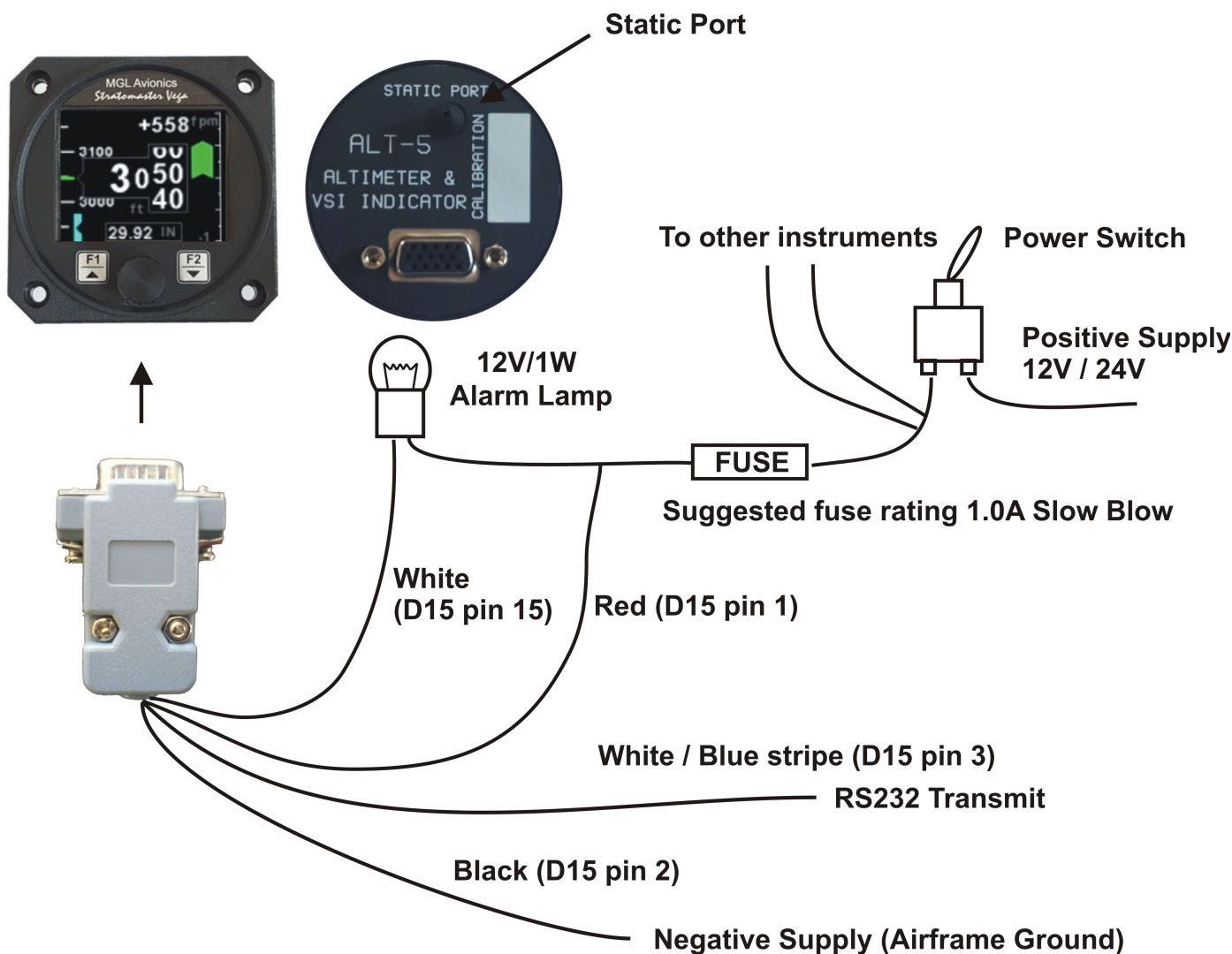

10.2 ALT-5 Cable connections

Main connector (D15 connector: Unit Female, Cable Male)

D15 Pin	Color	Function
1	Red	8-30Vdc power via power switch / circuit breaker and fuse.
2	Black	Ground.
3	White/Blue Stripe	RS232 Transmit data (Firmware upgrading / RS232 Altitude output)
4	-	RS232 Receive data (Firmware upgrading)
15	White	Alarm Output (Open collector)

11 Cleaning

The unit should not be cleaned with any abrasive substances. The screen is very sensitive to certain cleaning materials and should only be cleaned using a clean, damp cloth.

Warning: The ALT-5 is not waterproof, serious damage could occur if the unit is exposed to water and/or spray jets.

12 Warranty

This product carries a warranty for a period of one year from date of purchase against faulty workmanship or defective materials, provided there is no evidence that the unit has been mishandled or misused. Warranty is limited to the replacement of faulty components and includes the cost of labor. Shipping costs are for the account of the purchaser.

Damage as a result of applying excessive pressure to the static pressure port are excluded from warranty.

Note: Product warranty excludes damages caused by unprotected, unsuitable or incorrectly wired electrical supplies and or sensors, and damage caused by inductive loads.

13 Disclaimer

Operation of this instrument is the sole responsibility of the purchaser of the unit. The user must make themselves familiar with the operation of this instrument and the effect of any possible failure or malfunction.

This instrument is not certified by the FAA. Fitting of this instrument to certified aircraft is subject to the rules and conditions pertaining to such in your country. Please check with your local aviation authorities if in doubt. This instrument is intended for ultralight, microlight, homebuilt and experimental aircraft. Operation of this instrument is the sole responsibility of the pilot in command (PIC) of the aircraft. This person must be proficient and carry a valid and relevant pilot's license. This person has to make themselves familiar with the operation of this instrument and the effect of any possible failure or malfunction. Under no circumstances does the manufacturer condone usage of this instrument for IFR flights.

IMPORTANT NOTICE:

You must make your own determination if the products sold by MGL Avionics are safe and effective for your intended applications. MGL Avionics makes no representations or warranties as to either the suitability of any of the products we sell as to your particular application or the compatibility of any of the products we sell with other products you may buy from us or anywhere else, and we disclaim any warranties or representations that may otherwise arise by law. Also, we offer no specific advice on how to install any of the products we sell other than passing along anything that may have been provided to us by the manufacturer or other issues. If you are in need of further information or guidance, please turn to the manufacturer, FAA Advisory Circulars and guidance materials, the Experimental Aircraft Association, or other reputable sources.

The manufacturer reserves the right to alter any specification without notice.

Other instruments in the *Stratomaster Vega* series

AHRS-1	Artificial Horizon and Magnetic Compass Indicator
ALT-5	Altimeter and Vertical Speed Indicator (VSI)
ASI-4	Airspeed Indicator (ASI)
ASV-1	Altimeter, Airspeed (ASI) and Vertical Speed Indicator (VSI)
EMS-1	Engine Monitoring System
FF-4	Fuel Computer
INFO-1	Information Display (G-force meter, RTC, Outside Air Temperature (OAT), Volts and Current display)
MAG-1	Magnetic Compass Indicator
MAP-3	Manifold Pressure and RPM Indicator
RPM-1	Universal Engine / Rotor RPM Indicator
TC-4	4-Channel Thermocouple (EGT/CHT) Indicator
TP-3	Universal Temperature and Pressure Indicator