



DMA00514F

Emergency Locator Transmitters

Orolia S.A.S

INSTALLATION MANUAL USER MANUAL



REMOTE CONTROL PANELS RC200 / RC200 NVG

P/N: S1820513-11 / S1820513-14

Users are kindly requested to notify Orolia Customer Support of any discrepancy, omission or error found in this manual. Please register a support ticket via the Orolia website:
<https://www.orolia.com/support/>

THIS DOCUMENT IS COPYRIGHT © **2022 OROLIA S.A.S.** ALL RIGHTS ARE STRICTLY RESERVED. THIS DOCUMENT AND ANY ATTACHED MATERIALS CONTAINS PROPRIETARY AND CONFIDENTIAL INFORMATION AND DATA AND IS THE SOLE PROPERTY OF OROLIA S.A.S. THE DOCUMENTS, ANY ATTACHED MATERIALS AND/OR INFORMATION CONTAINED THEREIN MUST NOT BE USED, DISSEMINATED, OR DISTRIBUTED EXCEPT FOR THE AGREED PURPOSE. UNAUTHORIZED USE, REPRODUCTION, OR ISSUE TO ANY THIRD PARTY IS NOT PERMITTED WITHOUT THE PRIOR WRITTEN CONSENT OF THE OROLIA GROUP. THIS DOCUMENT IS TO BE RETURNED TO THE OROLIA GROUP WHEN THE AGREED PURPOSE IS FULFILLED.

TABLE OF CONTENTS

Introduction	1
KANNAD ELTs System Presentation	1
Description	2
General	2
Mechanical design	2
RCP installation and connection	3
Installation recommendations	3
Installation	3
Installation on the instrument panel	3
Installation below the instrument panel	3
Connection	4
Connection with DIN-12 connector or Programming dongle	5
Connection with stopping connector	6
Connection with programming dongle assy	8
Optional Outside Buzzer / Horn - Annunciator	10
Connection to ELT	10
Acceptance test procedure	11
Working mode	11
Controls	11
Working mode information	11
Remote control	11
Monitoring	12
Operation	13
Stand by mode	13
ON mode	13
RESET & TEST	13
Self test	13
RESET	14
RCP operational tests	15
Technical characteristics	16
Mechanical Characteristics	16
Material	16
Overall Dimensions	16
Weight	16
Electrical Characteristics	16
Electrical Interface	17
Compatibility list	18
Schematics and diagrams	19
RC200 Outline dimensions	19
RC200 drilling mask	20
Wiring diagram for KANNAD 406 AF-COMPACT Serie (3-wire) and INTEGRA ELTs 3 or 4-wire	21
Wiring diagram for other KANNAD 406 ELTs (4 or 5-wire)	22

TABLE OF CONTENTS

PAGE INTENTIONNALLY LEFT BLANK

1. Introduction

The instructions in this manual provide the information necessary for installation and operation with the RC200 and RC200 NVG remote control panels.

2. KANNAD ELTs System Presentation

The ELT system is composed of:

1. a transmitter;
2. a mounting bracket;
3. a remote control panel;
4. an outside antenna;
5. A DIN-12 connector or a “Programming Dongle” for pin-programming function (option);

The transmitter and bracket are installed in the aircraft near the tail.

The remote control panel is installed in the cockpit and connected to the ELT with a 3, 4 or 5-wire bundle (not supplied) according to the type of ELT ([Refer to 8. Compatibility list, page 18](#)).

A DIN-12 connector is used to connect the RCP bundle to the ELT, it may be replaced by a programming dongle fulfilling two functions:

- programming of ELT;
- connection of RCP bundle to ELT.

The outside antenna is mounted on the fuselage near the tail.

Figure 1: ELT system description

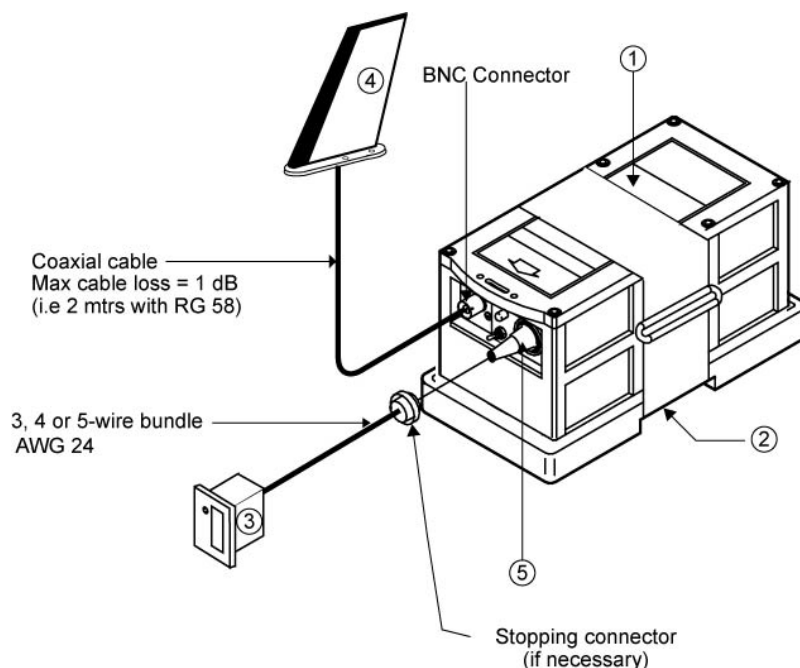

3. Description

A. General

The RC200 or RC200-NVG remote control panels are designed to be installed in cockpits of aircraft to enable the pilots to control the ELT on board.

The RC200 or RC200-NVG enable remote control of the primary functions of the KANNAD Emergency Locator Transmitters (Manual activation, Reset, Test) as well as visual monitoring.

RC200, P/N S1820513-11 is designed for all aircraft.

RC200-NVG, P/N S1820513-14 is a variant of RC200. This version is specially intended for military aircraft with NVIS compatible cockpit.

Both versions can be supplied with a special mounting tray:

- RC200 Kit P/N S1820513-18 including:
 - RC200 RCP, P/N S1820513-11
 - Kit female SUB-D 9 connector, P/N S1840506-01
 - Mounting tray, P/N 0132279
 - Two screws, self-threading, 30x10 (for use with plastic), P/N 0137388
- RC200-NVG Kit P/N S1820513-19 including:
 - RC200-NVG RCP, P/N S1820513-14
 - Kit female SUB-D 9 connector, P/N S1840506-01
 - Mounting tray, P/N 0132279
 - Two screws, self-threading, 30x10 (for use with plastic), P/N 0137388

Figure 2: RC200 Kit



B. Mechanical design

The RCPs are composed of a housing & a front panel with white markings. Both housing and front panel are made of Plastic ASA-PC LURAN SKR2867 CWU.

4. RCP installation and connection

A. Installation recommendations

The RCP shall be installed in the cockpit. The RCP shall be readily accessible from the pilot's normal seated position.

Connection of RC200 requires a 3, 4 or 5-wire bundle according to the ELT type ([Refer to 8. Compatibility list, page 18](#)). A pin-to-pin wiring has to be provided by the installer with AWG24 wires. Shielded cable is recommended.

B. Installation

The RCP are designed to be fixed:

- either on the instrument panel with 4 rivets bush;
- or below the instrument panel with a special mounting tray (supplied with kits S1820513-18 for RC200 or S1820513-19 for RC200 NVG)

(1) Installation on the instrument panel

- Determine RC200 location on the instrument panel.
- Mark a cut out on the instrument panel according to the drilling mask ([Refer to B. RC200 drilling mask, page 20](#)).
- Make the cut out.
- Mark the 4 holes needed for the RC200 using the drilling mask or the RC200 as a guide.
- Drill the 4 marked holes, diameter depending on rivet bush used.
- Install the RC200 by fitting into the cutout.
- Secure the RC200 (4 rivets bush recommended).

(2) Installation below the instrument panel

[Refer to Figure 3: Installation with the mounting tray, page 4.](#)

Determine RC200 location below the instrument panel (be sure the location meets the requirements established in RTCA DO-204).

- According to the "area to be drilled" (1) of the mounting tray (3), determine the location of the screws or rivets (2) used to secure the mounting tray to the instrument panel (4).
- Drill 2 holes on the mounting tray and on the instrument panel, diameter depending on screws or rivets used.
- Secure the mounting tray (3) to the instrument panel (4).
- Secure the RC200 (5) to the mounting tray (3) with the 2 screws (6) supplied (torque 0.8 Nm).

Figure 3: Installation with the mounting tray

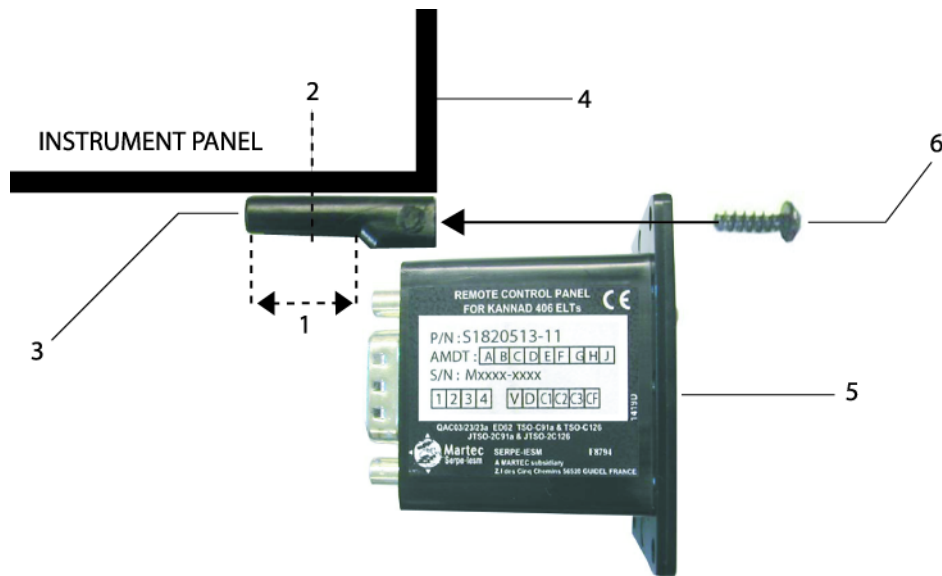

C. Connection

The bundle is a 3, 4 or 5-wire according to the ELT type ([Refer to 8. Compatibility list, page 18](#)) fitted with connectors on ELT and RCP sides. Bundles and connectors⁽¹⁾ are not supplied.

Note⁽¹⁾: The connector on RCP side must be a female D-SUB 9-Pin connector, P/N S1840506-01 (only supplied with kit S1820513-18).

On ELT side the connector can be:

- either a 12-pin plug male (standard DIN12 connector P/N S18 20 514-03);
- or a Programming Dongle, P/N S1820514-01;
- or a Programming Dongle ASSY, P/N S1820514-06 (Programming dongle already fitted with a 6-wire bundle and a DIN-12 female connector).

(1) *Connection with DIN-12 connector or Programming dongle*

In order to easily remove the programming dongle when connected, it is recommended to fit its cable with a stopping connector as close as possible to it (Refer to § Figure 4: Connection with stopping connector page 8).

A stopping connector can be made using a DIN-12 female (ref. BINDER 09-330-00-12) and a DIN-12 male connector (ref. BINDER 09-329-00-12) (Refer to § (2) Connection with stopping connector page 6).

Fabricate a 3, 4 or 5-wire AWG24 bundle (shielded preferred) long enough to reach between the ELT installation location and the cockpit panel RCP location.

Slide heat-shrinkable sleeves on both sides of each wire.

On the ELT side:

Solder the wires to the standard DIN12 connector or to the DIN12 connector of the programming dongle;

- KANNAD 406 AF COMPACT series (S1840501-xx) and INTEGRA ELTs (S185X501-XX)
 - solder the wires to pins A (RCP ON/RESET), G (RCP COMMON) and J (RCP LED) of the connector.
 - Solder a wire to pin H (RCP BUZZER) of the connector if an optional buzzer is connected (Only for INTEGRA ELTs, S185X501-XX).
- Other KANNAD 406 ELTs
 - solder the wires to pins A (RCP RESET), G (RCP COMMON), K (RCP ON), J (RCP LED).
 - Solder a wire to pin H (RCP BUZZER) of the connector if an optional buzzer is connected.

Put heat-shrinkable sleeves to protect the pins.

On the RCP side:

Solder the wires to the female D-SUB 9-Pin connector as follows:

- KANNAD 406 AF COMPACT series (S1840501-xx) and INTEGRA ELTs (S185X501-XX)
 - Strap pins 4 and 5 of the female D-SUB 9-Pin connector;
 - Pin 4 (RESET/TEST) has to be connected to Pin A (RCP ON/RESET) of the ELT;

- Pin 9 (RCP LED) has to be connected to Pin J (RCP LED) of the ELT;
- Pin 8 (RCP COMMON) has to be connected to Pin G (RCP COMMON) of the ELT
- For INTEGRA ELTs if connected to an optional outside buzzer or external warning:
 - Pin 2 (RCP BUZZER) has to be connected to Pin H (RCP BUZZER) of the ELT ([Refer to § \(4\) Optional Outside Buzzer / Horn - Annunciator page 10](#)).
- Other KANNAD 406 ELTs
 - Pin 4 (RCP RESET) has to be connected to Pin A (RCP RESET) of the ELT;
 - Pin 5 (RCP ON) has to be connected to Pin K (RCP ON) of the ELT;
 - Pin 8 (RCP COMMON) has to be connected to Pin G (RCP COMMON) of the ELT;
 - Pin 9 (RCP LED) has to be connected to Pin J (RCP LED) of the ELT;
 - Pin 2 (RCP BUZZER) has to be connected to Pin H (RCP BUZZER) of the ELT (only if an optional outside buzzer or external warning is used, [Refer to § \(4\) Optional Outside Buzzer / Horn - Annunciator page 10](#)).

Put heat-shrinkable sleeves to protect the pins.

(2) *Connection with stopping connector*

Fabricate a 3, 4 or 5-wire bundle, AWG 24 (shielded preferred) long enough to reach between the ELT installation location and the cockpit panel RCP location.

Cut the bundle to obtain a short cable and slide heat-shrinkable sleeves on both sides of each wire (short cable and long cable).

On the short cable:

- Solder the programming dongle or standard DIN-12 connector to one end of short cable.
- Solder a standard DIN-12 female connector to the other end of short cable according to programming dongle or male DIN-12 connector pin-out.
- Put heat-shrinkables sleeves to protect the pins.

On the long cable:

Solder a standard DIN-12 male connector on ELT side:

- KANNAD 406 AF COMPACT series (S1840501-xx) and INTEGRA

ELTs (S185X501-XX)

- solder the wires to pins A (RCP ON/RESET), G (RCP COMMON) and J (RCP LED) of the connector.
- For INTEGRA ELTs if connected to an optional outside buzzer or external warning:
 - Solder a wire to pin H (RCP BUZZER) of the connector.
- Other KANNAD 406 ELTs
 - solder the wires to pins A (RCP RESET), G (RCP COMMON), K (RCP ON), J (RCP LED).
 - Solder a wire to pin H (RCP BUZZER) of the connector if an optional buzzer is connected.
- Put heat-shrinkable sleeves to protect the pins.

Solder the wires to the female D-SUB 9-Pin connector as follows:

- KANNAD 406 AF COMPACT series (S1840501-xx) and INTEGRA ELTs (S185X501-XX)
 - Strap pins 4 and 5 of the female D-SUB 9-Pin connector;
 - Pin 4 (RESET/TEST) has to be connected to Pin A (RCP ON/RESET) of the ELT;
 - Pin 9 (RCP LED) has to be connected to Pin J (RCP LED) of the ELT;
 - Pin 8 (RCP COMMON) has to be connected to Pin G (RCP COMMON) of the ELT.
 - For INTEGRA ELTs if connected to an optional outside buzzer or external warning:
 - Pin 2 (RCP BUZZER) has to be connected to Pin H (RCP BUZZER) of the ELT ([Refer to § \(4\) Optional Outside Buzzer / Horn - Annunciator page 10](#)).
- Other KANNAD 406 ELTs
 - Pin 4 (RCP RESET) has to be connected to Pin A (RCP RESET) of the ELT;
 - Pin 5 (RCP ON) has to be connected to Pin K (RCP ON) of the ELT;
 - Pin 8 (RCP COMMON) has to be connected to Pin G (RCP COMMON) of the ELT;
 - Pin 9 (RCP LED) has to be connected to Pin J (RCP LED) of the ELT;
 - Pin 2 (RCP BUZZER) has to be connected to Pin H (RCP BUZZER) of the ELT (only if an optional outside buzzer or external warning is used,

- [Refer to § \(4\) Optional Outside Buzzer / Horn - Annunciator page 10](#)).
- Put heat-shrinkable sleeves to protect the pins of both connectors.

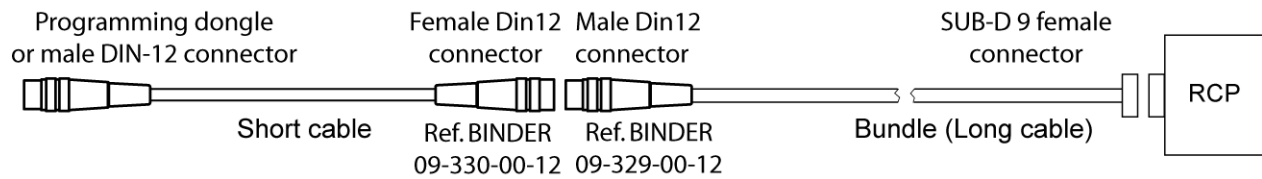

Figure 4: Connection with stopping connector

(3) Connection with programming dongle assy

A programming dongle assy (P/N S1820514-06) is a Programming dongle already fitted with a short 6-wire bundle and a DIN-12 female connector.

In this case, the 3, 4 or 5-wire bundle for programming dongle assy / RCP connection must be fitted with a standard DIN-12 male connector on ELT side and a female D-SUB 9-Pin connector on RCP side.

Fabricate a 3, 4 or 5-wire bundle, AWG 24 (shielded preferred) long enough to reach between the ELT installation location and the cockpit panel RCP location.

Slide heat-shrinkable sleeves on both sides of each wire.

On the ELT side, solder a DIN-12 male connector:

- KANNAD 406 AF COMPACT series (S1840501-xx) and INTEGRA ELTs (S185X501-XX)
 - solder the wires to pins A (RCP ON/RESET), G (RCP COMMON) and J (RCP LED) of the connector.
 - For INTEGRA ELTs if connected to an optional outside buzzer or external warning:
 - solder a wire to pin H (RCP BUZZER) of the connector.
- Other KANNAD 406 ELTs
 - solder the wires to pins A (RCP RESET), G (RCP COMMON), K (RCP ON), J (RCP LED).
 - Solder a wire to pin H (RCP BUZZER) of the connector if an optional buzzer is connected.
- Put heat-shrinkable sleeves to protect the pins.

On the RCP side:

- KANNAD 406 AF COMPACT series (S1840501-xx) and INTEGRA ELTs (S185X501-XX)
 - Strap pins 4 and 5 of the female D-SUB 9-Pin connector;

- Pin 4 (RESET/TEST) has to be connected to Pin A (RCP ON/RESET) of the ELT;
- Pin 9 (RCP LED) has to be connected to Pin J (RCP LED) of the ELT;
- Pin 8 (RCP COMMON) has to be connected to Pin G (RCP COMMON) of the ELT.
- For INTEGRA ELTs if connected to an optional outside buzzer or external warning:
 - Pin 2 (RCP BUZZER) has to be connected to Pin H (RCP BUZZER) of the ELT ([Refer to § \(4\) Optional Outside Buzzer / Horn - Annunciator page 10](#)).
- Other KANNAD 406 ELTs
 - Pin 4 (RCP RESET) has to be connected to Pin A (RCP RESET) of the ELT;
 - Pin 5 (RCP ON) has to be connected to Pin K (RCP ON) of the ELT;
 - Pin 8 (RCP COMMON) has to be connected to Pin G (RCP COMMON) of the ELT;
 - Pin 9 (RCP LED) has to be connected to Pin J (RCP LED) of the ELT;
 - Pin 2 (RCP BUZZER) has to be connected to Pin H (RCP BUZZER) of the ELT (only if an optional outside buzzer or external warning is used, [Refer to § \(4\) Optional Outside Buzzer / Horn - Annunciator page 10](#))

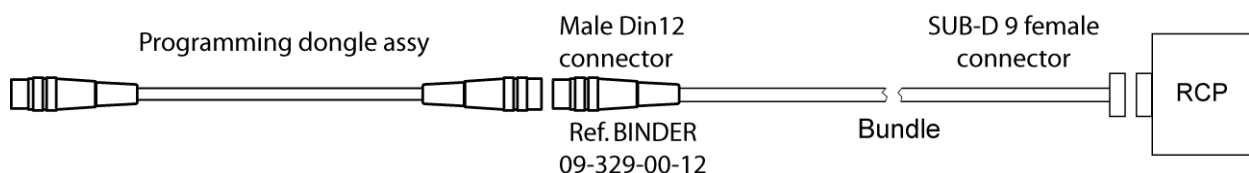

Figure 5: Connection with programming dongle assy

(4) Optional Outside Buzzer / Horn - Annunciator

Note: Not compatible with KANNAD 406 AF-COMPACT series.

- Optional outside buzzer

An optional outside buzzer can be connected to pin 7 (BUZZER OUT) and pin 3 (BUZZER GND) of RCP. In this case:

- Pin 2 (RCP BUZZER) of RCP has to be connected to pin H (RCP BUZZER) of the ELT.

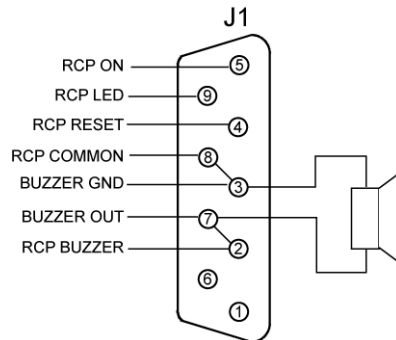

Figure 6: Buzzer connection

CAUTION: If the load is higher than 60V@1A, a relay should be installed.

If the external warning is connected:

- Pin 2 (RCP BUZZER) of RCP has to be connected to pin H (RCP BUZZER) of the ELT.

The outside horn will operate in the same way than the buzzer of the RCP.

(5) Connection to ELT

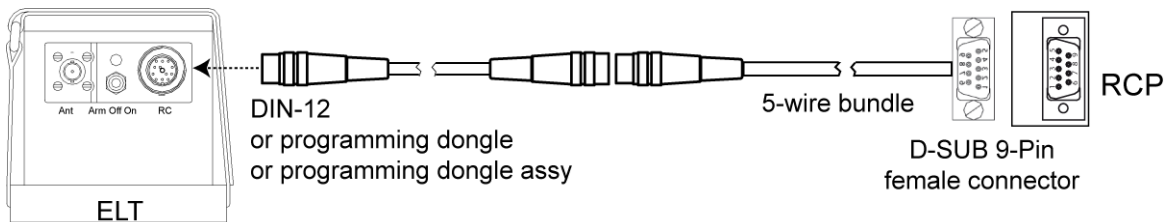

Figure 7: Connection of RCP

- On the ELT side:
 - connect the stopping connector if any or connect the programming dongle assy to the DIN-12 male connector of 3, 4 or 5-wire bundle.
 - connect the DIN-12 connector (or programming dongle or programming dongle assy) to J1 of the ELT;
- On the RCP side connect the female D-SUB 9-Pin connector to the male D-SUB 9-Pin connector.

D. Acceptance test procedure

Perform an RCP test ([Refer to D. RCP operational tests, page 15](#)).

5. Working mode

A. Controls

The following elements are to be found on the RC200 remote control panels:

1. a 3-position switch (ON, ARMED, RESET & TEST);
2. a red visual indicator.

Figure 8: RCP controls

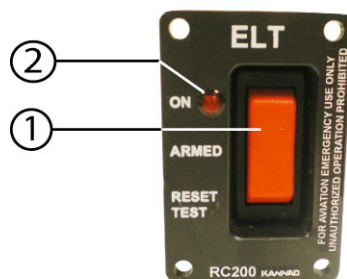

The visual indicator gives an indication on the working mode of the beacon:

- After the self-test:
 - one long flash indicates that the system is operational and that no error were found;
 - a series of short flash indicates the test has failed.
- In operation mode:
 - periodic flashes during homer transmissions;
 - long flash during 406 transmission.

B. Working mode information

The RC200 remote control panels enable remote control and remote monitoring of the KANNAD ELTs **provided that the ELT switch is in armed position.**

(1) Remote control

Remote control is done through a 3-position switch:

1. ON (transmission) enables manual activation of the ELT;
2. ARMED (stand by mode to enable automatic activation by the shock sensor of ELT) is an idle position. Unless there is an emergency, the switch must stay in this position.

3. RESET & TEST is used either to stop the ELT transmission if activated or to perform a self-test.

Figure 9: 3-position switch

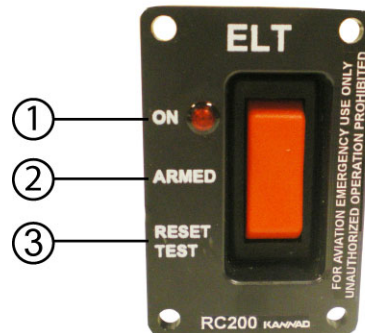

As required by regulations, the OFF mode is not available on the remote control panel (RTCA DO 204 § 2.2.6.c, EUROCAE ED 62 § 2.5.1.1) but directly on the ELT itself by switching it in OFF position.

IMPORTANT: TEST/RESET (downwards) is a momentary position.

Refer to operation manuals of the ELTs for precise information on these modes.

(2) *Monitoring*

Monitoring is done through a visual indicator ([Refer to Figure 8: RCP controls, page 11](#)) operating in the same way than those of the ELT:

Transmission:

- 1 short flash every 0.5 or 0.7 seconds during homer transmission;
- 1 long flash during ELT transmission on 406 MHz.

Self-test:

([Refer to C. RESET & TEST, page 13](#)).

Refer to operation manuals of the ELTs for precise information on these modes.

6. Operation

Figure 10: Operating modes

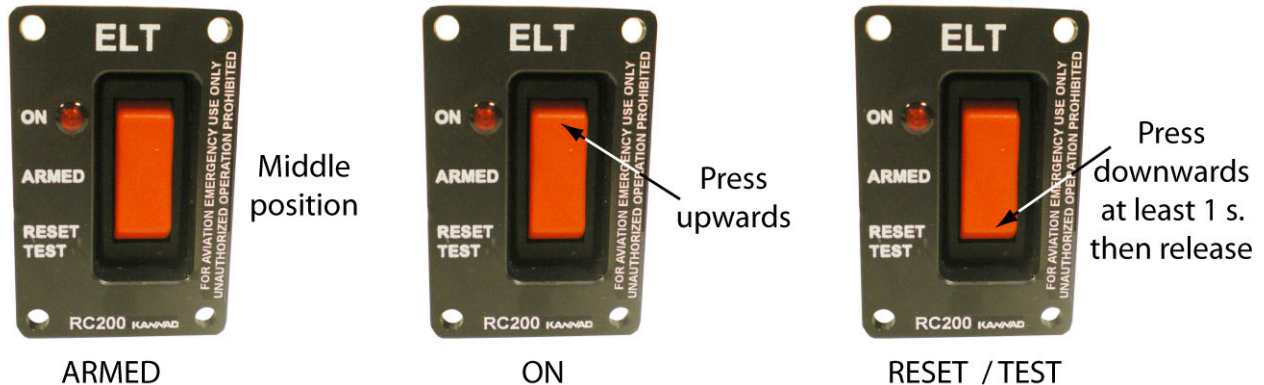

A. Stand by mode

The stand by mode is the ARMED position (idle position). The switch is in the middle position.

This mode is used to enable automatic activation by the shock sensor of the ELT **provided that the ELT switch is in armed position**. Unless there is an emergency, the switch must stay in this position.

B. ON mode

This mode is used to activate manually the ELT. When this mode is selected, the ELT transmission is activated.

- Press the switch upwards.
 - A self test is first performed ([Refer to C. RESET & TEST, page 13](#)).
- After the self-test (max. duration 15 seconds), the ELT starts to transmit:
 - The visual indicator is flashing in the same way than those of the ELT;
 - The buzzer of the ELT (and outside buzzer if connected) is activated.

C. RESET & TEST

This mode is used either to perform a self-test or to stop the ELT transmission if activated.

(1) Self test

IMPORTANT: Do not perform self-test without the antenna connected.

Self-test must be performed regularly by a pilot or maintenance personnel from the Remote Control Panel but should not be done more often than specified in ELT user manual.

However, each self-test consumes energy from the battery. Should self-tests be carried out more often than the maximum allowed, the battery life-time of the ELT might be shorter than specified.

Press the switch downwards for at least 1 second then release it (the switch comes back in ARMED position):

The visual indicator is flashing as follows:

- one short flash at the beginning of the self-test sequence

After a few seconds, the test result is displayed with the visual indicator as follows:

- one long flash indicates the system is operational and that no error conditions were found;
- a series of short flashes indicates the test has failed:
Refer to the ELT manual.

(2) *RESET*

This mode is used to stop the ELT when activated.

If the ELT is activated, the visual indicator of RCP is flashing in the same way than the one of the ELT:

- Press the switch downwards for at least 1 second then release it (the switch comes back in ARMED position):
- The visual indicator is OFF.

IMPORTANT: On ELTs P/N S182X502-XX, if a RESET is performed from RCP with the ELT manually activated (ON position on the front panel of the ELT), the ELT transmission will stop for max. 50 seconds then start again.

In this case, on the RCP:

- **The led is off for max. 50 seconds then flash again.**

D. RCP operational tests

Check correct operation of RCP visual indicator by switching ELT and RCP as described in the following sequential procedure, [Figure 11: RCP visual indicator operation](#) (with ELT switch in the «ARM» position).

Figure 11: RCP visual indicator operation

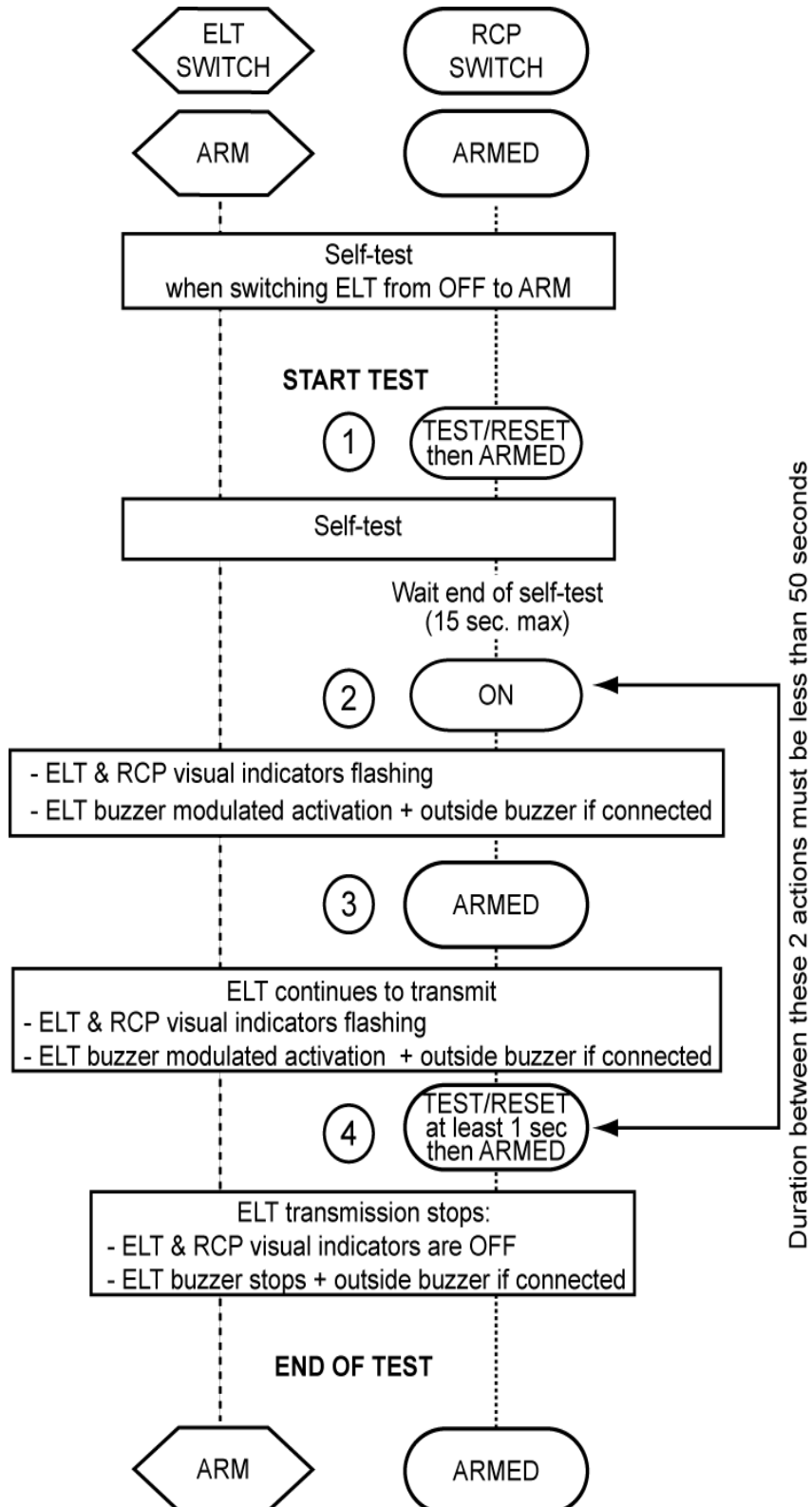

7. Technical characteristics

A. Mechanical Characteristics

The RCP is designed to be fixed with four screws on the instrument panel or below the instrument panel with a special mounting tray (supplied with KIT S1820513-18 for RC200 or S1820513-19 for RC200-NVG).

(1) Material

- **Housing and Front plate**

- Plastic ASA-PC LURAN SKR2867 CWU.
- Color: black with matt finish.
- Fire classification: UL94V-0.
- Front face with white silk-screen markings.
- Cleaning: The plate can be cleaned with absorbent cotton-wool soaked in alcohol.

- **Switch**

- Nylon 6.6.
- Fire classification: UL94V-2.

(2) Overall Dimensions

- Outline dimensions
33 x 50 x 43 mm (1.3 x 1.97 x 1.69 inches).

(3) Weight

- Approx. 35 gr. (0.077 lbs), 55 gr. (0.121 lbs) with mounting tray, screws and connector

B. Electrical Characteristics

- Visual indicator: from ELT power supply.

C. Electrical Interface

When installed on board, J1 of RCP has to be connected to J1 of the ELT and can also be connected to an optional outside horn or annunciator (max. 60V@1A) or a relay if much power is required.

Connection of the RCP requires a 3-wire bundle, when connected to a KANNAD 406 AF-Compact ELT (P/N S1840501-XX), a 3 or 4-wire bundle when connected to an INTEGRA ELTs (P/N S18X510-XX) and a 4 or 5-wire bundle, when connected to another ELT ([Refer to 8. Compatibility list, page 18](#)).

A single male 9-pin D-SUB connector (J1), enables these connections.

Receptacle (J1)	
Standard designation	D-SUB Male 9-Pin
Number of contacts	9

Locking device	
Inserts	Threaded UNC 4-40

Mating connector type	
Standard designation	D-SUB Female 9-Pin
Number of contacts	9
Supplier / Reference	S1840506-01

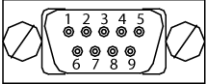
9-Pin connector pin-out	Signal name	Destination	
Mating connector Back face of inserts 	1	EXT WARNING 2	Horn / Annunciator
	2	RCP BUZZER	ELT
	3	BUZZER GND	BUZZER
	4	RCP RESET	ELT
	5	RCP ON	ELT
	6	EXT WARNING 1	A/C DC POWER
	7	BUZZER OUT	BUZZER
	8	RCP COMMON	ELT
	9	RCP LED	ELT

8. Compatibility list

ELT	PART NUMBER	N° of wires required
KANNAD 406 AF COMPACT	S1840501-01	3
KANNAD 406 AF COMPACT ER	S1840501-04	3
KANNAD 406 AP	S1820502-02	4 or 5
KANNAD 406 AP-H	S1820502-04	4 or 5
KANNAD 406 AF	S1821502-02	4 or 5
KANNAD 406 AF-H	S1822502-02	4 or 5
KANNAD 121 AF	S1824502-02	4 or 5
KANNAD 121 AF-H	S1826502-02	4 or 5
AP INTEGRA (ER)	S1850501-01	3 or 4
AP INTEGRA	S1850501-02	3 or 4
AP INTEGRA (ER-N)	S1850501-03	3 or 4
AF INTEGRA (ER)	S1851501-01	3 or 4
AF INTEGRA	S1851501-02	3 or 4
AF INTEGRA (ER-N)	S1851501-03	3 or 4
AF-H INTEGRA (ER)	S1852501-01	3 or 4
AF-H INTEGRA	S1852501-02	3 or 4
AF-H INTEGRA (ER-N)	S1852501-03	3 or 4
AP-H INTEGRA (ER)	S1854501-02	3 or 4
AP-H INTEGRA	S1854501-01	3 or 4
AP-H INTEGRA (ER-N)	S1854501-03	3 or 4

9. Schematics and diagrams

A. RC200 Outline dimensions

Note: all dimensions are in millimeters
 (inches in brackets)

Tolerance: ± 0.2 mm (0.008)

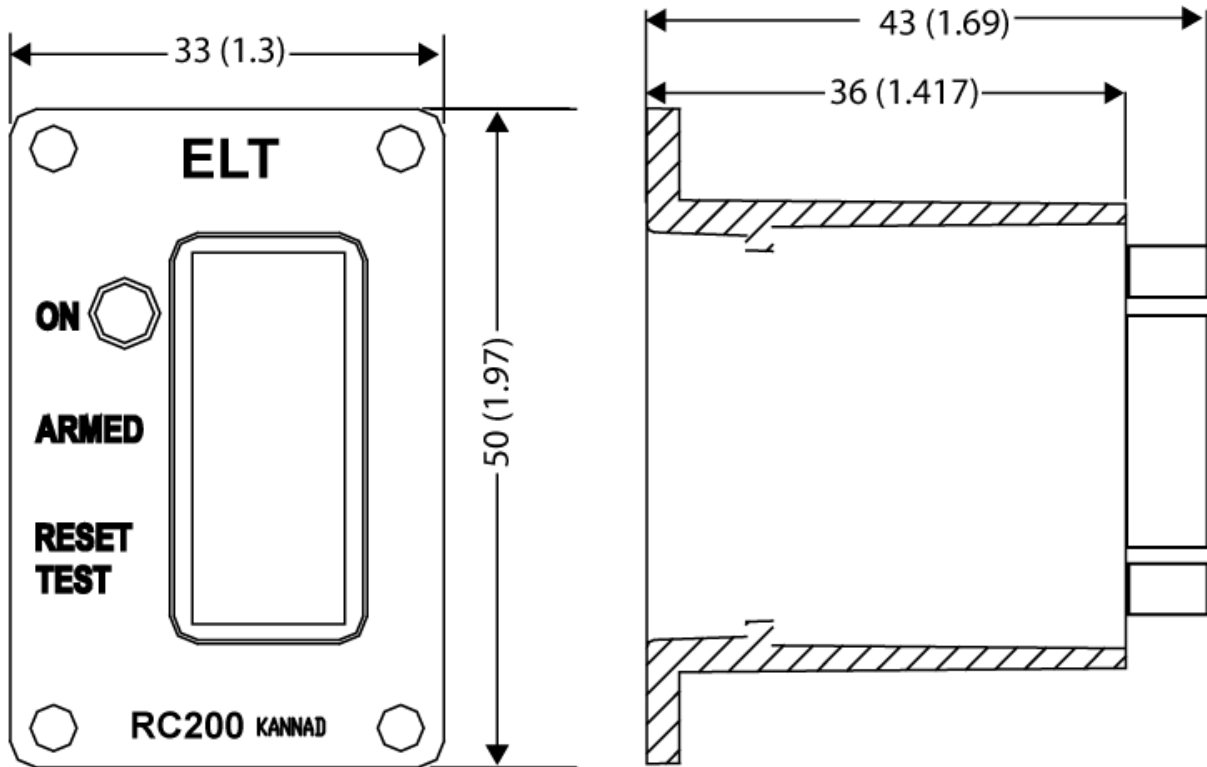

CONTROL PANEL

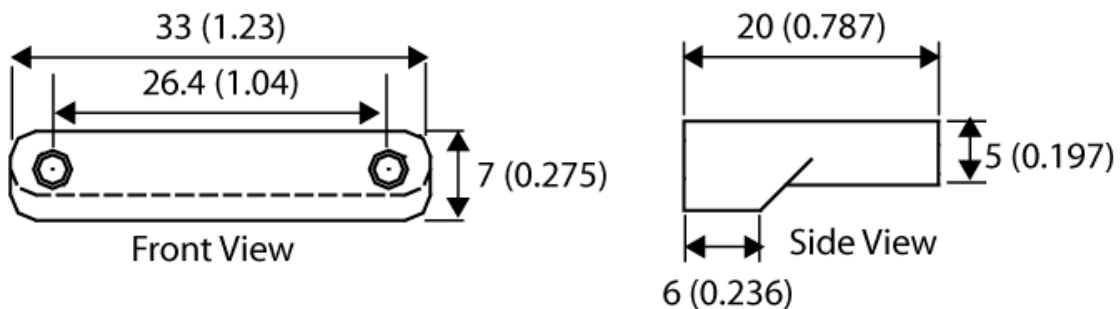

MOUNTING TRAY

B. RC200 drilling mask

Note: all dimensions are in millimeters
(inches in brackets)

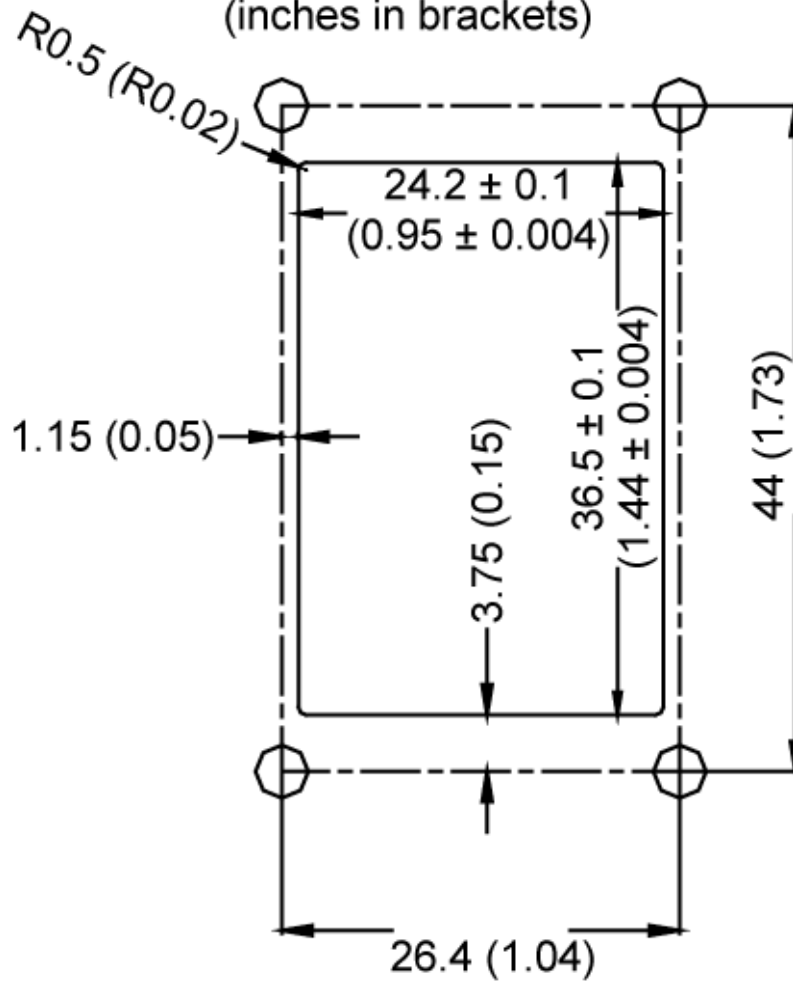

C. Wiring diagram for KANNAD 406 AF-COMPACT Serie (3-wire) and INTEGRA ELTs 3 or 4-wire

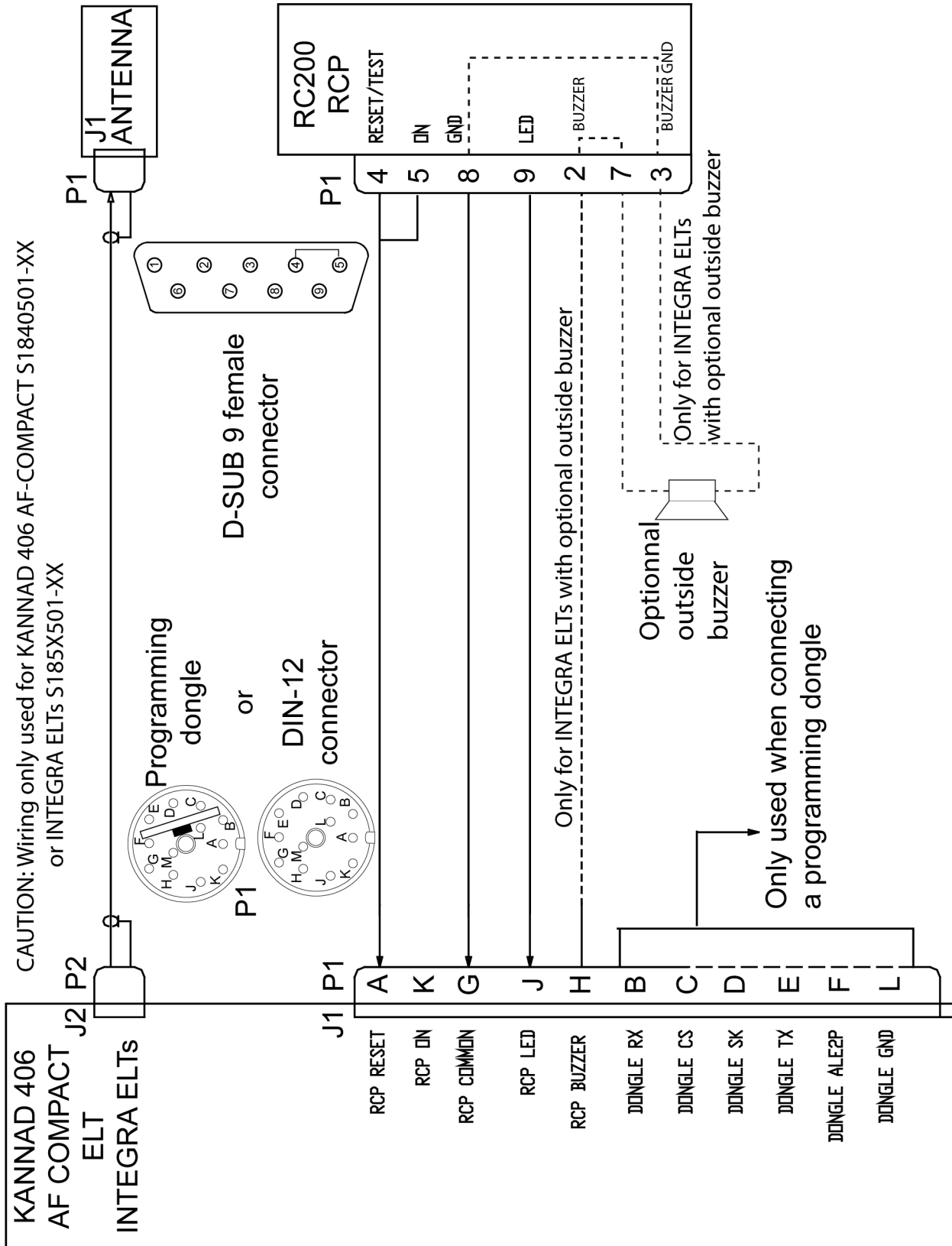

D. Wiring diagram for other KANNAD 406 ELTs (4 or 5-wire)

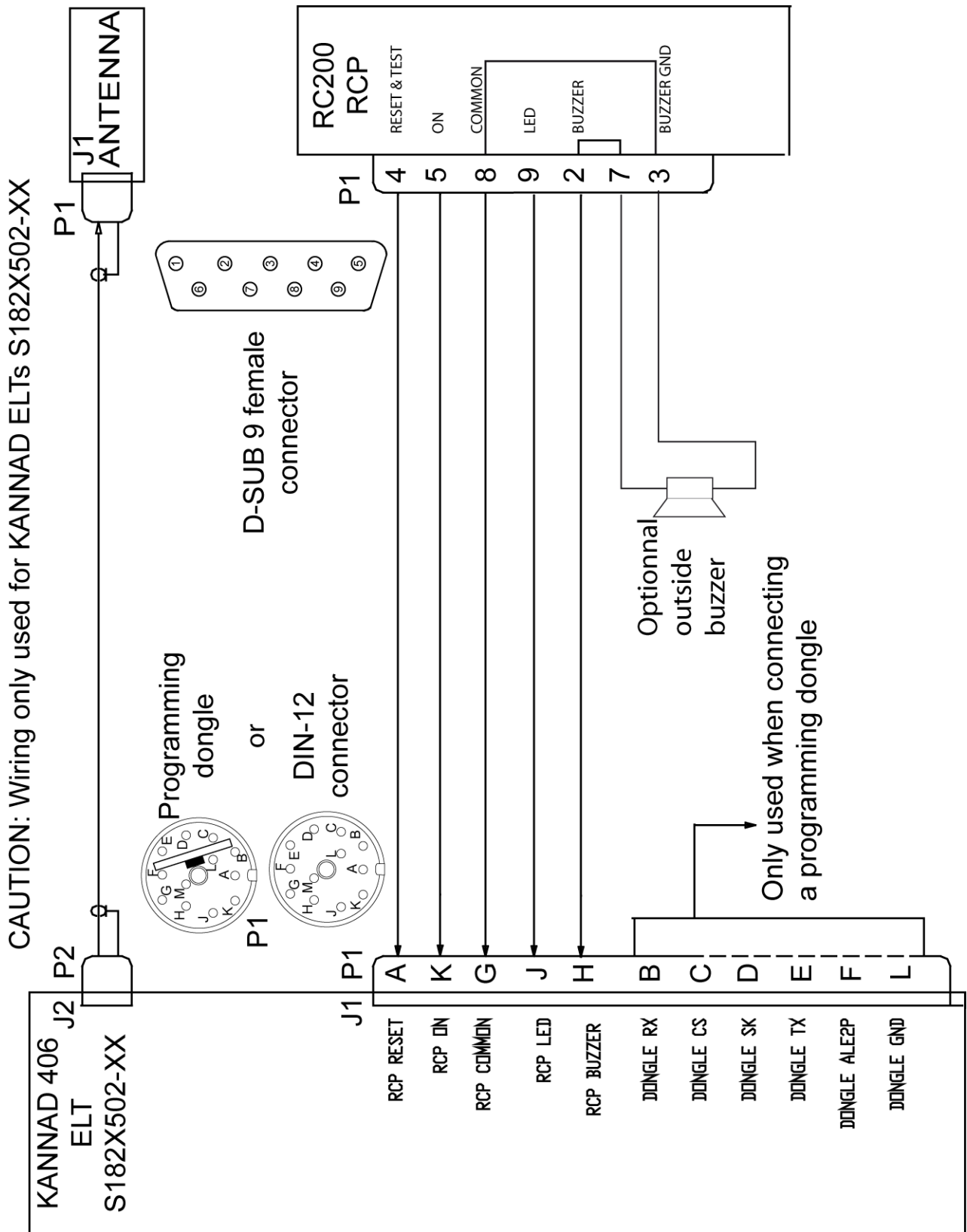

Distributed by



Manufactured by

Orolia S.A.S

Z.I. des Cinq Chemins CS10028

56520 GUIDEL - FRANCE

Phone: +33 (0) 2 97 02 49 49

Web: <https://www.orolia.com>

DMA00514F